

STATE PLAN UNDER TITLE XIX  
OF THE SOCIAL SECURITY ACT  
MEDICAL ASSISTANCE PROGRAM

HCFA-AT-80-38 (BPP)  
MAY 22, 1980

Revision: HCFA-PM-87-4 (BERC)  
MARCH 1987

OMB No. 0938-

STATE PLAN UNDER TITLE XIX OF THE SOCIAL SECURITY ACT  
Medical Assistance Program

State/Territory: North Carolina

TABLE OF CONTENTS

SECTION	PAGE NUMBERS
State Plan Submittal Statement.....	I
SECTION I - SINGLE STATE AGENCY ORGANIZATION.....	2
1.1 Designation and Authority.....	2
1.2 Organization for Administration.....	7
1.3 Statewide Operation.....	8
1.4 State Medical Care Advisory Committee.....	9

---

TN No. 87-5  
Supersedes  
TN No. \_\_\_\_

Approval Date Jul 23 1987

Effective Date 4/187

HCFA ID:

1002P/00I0P

<u>SECTION</u>	<u>PAGE NUMBERS</u>
SECTION 2 - COVERAGE AND ELIGIBILITY .....	10
2.1 Application, Determination of Eligibility and Furnishing Medicaid ....	10
2.2 Coverage and Condition of Eligibility .....	12
2.3 Residence.....	13
2.4 Blindness.....	14
2.5 Disability.....	15
2.6 Financial Eligibility.....	16
2.7 Medicaid Furnished Out of State .....	18

Revision: HCFA-PM-87-4 (BERC)  
MARCH 1987

OMB No. 0938-0193

<u>SECTION</u>	<u>PAGE NUMBERS</u>
SECTION 3 - SERVICES: GENERAL PROVISIONS.....	19
3.1 Amount, Duration, and Scope of Services.....	19
3.2 Coordination of Medicaid with Medicare Part B.....	29
3.3 Medicaid for Individuals Age 65 or Over in Institutions for Mental Diseases .....	30
3.4 Special Requirements Applicable to Sterilization Procedures...../.....	31
3.5 Medicaid for Medicare Cost Sharing for Qualified Medicare Beneficiaries.....	31a
3.6 Ambulatory Prenatal Care for Pregnant Women during Presumptive Eligibility Period.....	31b

<u>SECTION</u>	<u>PAGE NUMBERS</u>
SECTION 4 - GENERAL PROGRAM ADMINISTRATION.....	32
4.1 Methods of Administration .....	32
4.2 Hearings for Applicants and Recipients.....	33
4.3 Safeguarding Information on Applicants and Recipients.....	34
4.4 Medicaid Quality Control.....	35
4.5 Medicaid Agency Fraud Detection and Investigation Program.....	36
4.6 Report.....	37
4.7 Maintenance of Records.....	38
4.8 Availability of Agency Program Manuals.....	39
4.9 Reporting Provider Payments to the Internal Revenue Service.....	40
4.10 Free Choice of Providers.....	41
4.11 Relations with Standard-Setting and Survey Agencies.....	42
4.12 Consultation to Medicaid Facilities.....	44
4.13 Required Provider Agreement.....	45
4.14 Utilization Control.....	46
4.15 Inspections of Care in Skilled Nursing and Intermediate Care Facilities and Institutions for Mental Diseases.....	51
4.16 Relations with State Health and Vocational Rehabilitation Agencies and Title V Grantees.....	52
4.17 Liens and Recoveries.....	53
4.18 Cost Sharing and Similar Charges.....	54
4.19 Payment for Services.....	57

<u>NUMBERS</u>	<u>SECTION</u>	<u>PAGE</u>
4.20	Direct Payments to Certain Recipients for Physicians' or Dentists' Services.....	67
4.21	Prohibition Against Reassignment of Provider Claims.....	68
4.22	Third Party Liability.....	69
4.23	Use of Contracts.....	71
4.24	Standards for Payments for Skilled Nursing and Intermediate Care Facility Services.....	72
4.25	Program for Licensing Administrators of Nursing Homes.....	73
4.26	RESERVED.....	74
4.27	Disclosure of Survey Information and Provider or Contractor Evaluation.....	75
4.28	Appeals Process for Skilled Nursing and Intermediate Care Facilities.....	76
4.29	Conflict of Interest Provisions.....	77
4.30	Exclusion of Providers and Suspension of Practitioners Convicted and other Individuals.....	78
4.31	Disclosure of Information by Providers and Fiscal Agents.....	79
4.32	Income and Eligibility Verification System.....	79
4.33	Medicaid Eligibility Cards for Homeless Individuals.....	79a
4.34	Systematic Alien Verification for Entitlements.....	79b
4.35	Remedies for Skilled Nursing and Intermediate Care Facilities that Do Not Meet Requirements of Participation.....	79c
4.43	Cooperation with Medicaid Integrity Program Efforts	79z
4.46	Provider Screening and Enrollment	90

Revision:  
0193

HCFA-PM-97-4 (BERC)  
MARCH 1987

OMB No. 0938-

<u>NUMBERS</u>	<u>SECTION</u>	<u>PAGE</u>
SECTION 5 - PERSONNEL ADMINISTRATION.....		80
5.1 Standards of Personnel Administration.....		80
5.2 RESERVED.....		81
5.3 Training Programs; Sub-professional and Volunteer Programs.....		82

Revision:

HCFA-PM-87-4  
MARCH 1987

(BERC)

OMB No. 0938-0193

<u>NUMBERS</u>	<u>SECTION</u>	<u>PAGE</u>
SECTION 6 - FINANCIAL		
ADMINISTRATION.....		83
6.1 Fiscal Policies and Accountability.....		83
6.2 Cost Allocation.....		84
6.3 State Financial Participation.....		85



Revision:  
0938-

HCFA-PM-91- (BPD)  
August 1991

OMB No.

<u>NUMBERS</u>	<u>SECTION</u>	<u>PAGE</u>
	SECTION 7 - GENERAL PROVISIONS.....	86
7.1	Plan Amendments.....	86
7.2	Nondiscrimination.....	87
7.3	Maintenance of AFDC Effort.....	88
7.4	State Governor's Review.....	89

LIST OF ATTACHMENTS

<u>No.</u>	<u>Title of Attachment</u>
*I.I-A	Attorney General's Certification
*I.I-B	Waivers under the Intergovernmental Cooperation Act
1.2-A	Organization and Function of State Agency
1.2-B	Organization and Function of Medical Assistance Unit
1.2-C	Professional Medical and Supporting Staff
1.2-D	Description of Staff Making Eligibility Determination
*2.2-A	Groups Covered and Agencies Responsible for Eligibility Determinations
*Supplement 1 -	Reasonable Classifications of Individuals under the Age of 21, 20, 19 and 18
*Supplement 2 -	Definitions of Blindness and Disability <u>(Territories only)</u>
*Supplement 3 -	Method of Determining Cost Effectiveness of Caring for Certain Disabled Children at Home
*2.6-A	Eligibility Conditions and Requirements <u>(States only)</u>
• Supplement 1 -	Income Eligibility Levels - Categorically Needy, Medically Needy and Qualified Medicare Beneficiaries
• Supplement 2 -	Resource Levels - Categorically Needy, Including Groups with Incomes Up to a Percentage of the Federal Poverty Level, Medically Needy, and Other Optional Groups
• Supplement 3 -	Reasonable Limits on Amounts for Necessary Medical or Remedial Care Not Covered under Medicaid
• Supplement 4 -	Section 1902(f) Methodologies for Treatment of Income that Differ from those of the SSI Program

\*Forms Provided

---

TN No. 03-04  
Supersedes  
TN No. 92-01

Approval Date: **NOV 18 2003**

Effective Date 8/13/2003

HCFA ID: 7982E

No.Title of Attachment

- Supplement 5 - Section 1902(f) Methodologies for Treatment of Resources that Differ from those of the SSI Program
- Supplement 5a- Methodologies for Treatment of Resources or individuals With Income Up to a Percentage of the Federal Poverty Level
- Supplement 6 - Standards for Optional State Supplementary Payments
- Supplement 7 - Income Levels for 1902(f) States - Categorically Needy Who Are Covered under Requirements More Restrictive than SSI
- Supplement 8 - Resource Standards for 1902(f) States - Categorically Needy
- Supplement 8a- More Liberal Methods of Treating Income Under Section 1902(r)(2) of the Act
- Supplement 8b- More Liberal Methods of Treating Resources Under Section 1902(r)(2) of the Act
- Supplement 8c - State Long-Term Care Insurance Partnership
- Supplement 9 - Transfer of Resources
- Supplement 10- Consideration of Medicaid Qualifying Trust--Undue Hardship
- Supplement II - Cost-Effective Methods for COBRA Groups

(States and Territories)\*2.6-A Eligibility Conditions and Requirements (Territories only)

- Supplement I - Income Eligibility Levels - Categorically Needy, Medically Needy, and Qualified Medicare Beneficiaries
- Supplement 2 - Reasonable limits on Amounts for Necessary Medical or Remedial Care Not Covered under Medicaid
- Supplement 3 - Resource Levels for Optional Groups with Incomes Up to a Percentage of the Federal Poverty Level and Medically Needy
- Supplement 4 - Consideration of Medicaid Qualifying Trusts--Undue Hardship
- Supplement 5 - More Liberal Methods of Treating Income under Section 1902 (r)(2) of the Act
- Supplement 6 - More Liberal Methods of Treating Resources under Section 1902 (r)(2) of the Act

\*Forms Provided

TN No. 10-027

Supersedes

TN No. 92-27Approval Date: 01-06-11Effective Date 01/01/2011

HCFA ID: 7982E

HCFA ID: 7982E

No. Title of Attachment

- \*3.1-A Amount, Duration, and Scope of Medical and Remedial Care and Services Provided to the Categorically Needy
  - \*Supplement I Care Management Services
  - Supplement 2 Alternative Health Care Plans for Families Covered Under Section 1925 of the Act
- \*3.1-B Amount, Duration, and Scope of Services Provided Medically Needy Groups
- 3.1-C Standards and Methods of Assuring High Quality Care
- 3.1-D Methods of Providing Transportation
- \*3.1-E Standards for the Coverage of Organ Transplant Procedures
- 3.1-F State Option to Use Managed Care
- 4.11-A Standards for Institutions
- 4.14-A Single Utilization Review Methods for Intermediate Care Facilities
- 4.14-B Multiple Utilization Review Methods for Intermediate Care Facilities
- 4.16-A Cooperative Arrangements with State Health and State Vocational Rehabilitation Agencies and with Title V Grantees
- 4.17-A Determining that an Institutionalized Individual Cannot Be Discharged and Returned Home
- \*4.18-A Charges Imposed on Categorically Needy
- \*4.18-B Medically Needy - Premium
- \*4.18-C Charges Imposed on Medically Needy and other Optional Groups
- \*4.18-D Premiums Imposed on Low Income Pregnant Women and Infants
- \*4.18-E Premiums Imposed on Qualified Disabled and Working Individuals
- 4.19-A Methods and Standards for Establishing Payment Rates – Inpatient Hospital Care

\*Forms Provided

**Revision:** HCFA-PM-91-8 (MB)  
No.: October 1991

OMB  
Page 4

<u>No.</u>	<u>Title of Attachment</u>
4.19-B	Methods and Standards for Establishing Payment Rates - Other Types of Care
	* Supplement I - Methods and Standards for Establishing Payment Rates for Title XVIII Deductible/Coinsurance
4.19-C	Payments for Reserved Beds
4.19-D	Methods and Standards for Establishing Payment Rates - Skilled Nursing and Intermediate Care Facility Services
4.19-E	Timely-Claims Payment - Definition of Claim
4.20-A	Conditions for Direct Payment for Physicians' and Dentists' Services
4.22-A	Requirements for Third Party Liability-Identifying Liable Resource
*4.22-B	Requirements for Third Party Liability - Payment of Claims
*4.22-C	Cost-Effective Methods for Employer-Based Group Health Plans
*4.32-A	Income and Eligibility Verification System Procedures: Requests to Other State Agencies
*4.33-A	Method for Issuance of Medicaid Eligibility Cards to Homeless Individuals
7.2-A	Methods of Administration - Civil Rights (Title VI)

\*Forms Provided

---

TN No. 92-27  
Supersedes  
TN No. 92-01

Approval Date 1-31-94

Effective Date 7/1/92

HCFA ID: 7982E

WAIVERS OF STATE PLAN PROVISIONS

State: North Carolina

Type of Waiver

- 1915(b)(1) - Case Management System
- 1915(b)(2) - Locality as a Central Broker
- 1915(b)(3) - Sharing of Cost Savings (through:
  - Additional Services
  - Elimination of Copayments)
- 1915(b)(4) - Restriction of Freedom of Choice
- 1915(c) -  Home and Community-Based Services Waiver(non-model format).
- Home and Community-Based Services Waiver (model format).
- 1916(a)(3)and/or (b)(3) - Nominality of Copayments

Title of Waiver and Brief Description:

Home and Community-Based Waiver for Disabled or Mentally Retarded/Developmentally Disabled Children.

Approval Date: 12/6/83      Renewal Date(s):

Effective Date: 7/1/83

Specific State Plan Provisions Waived and Corresponding Plan Section(s):

Comparability: Section 1902(a)(10)

Statewideness: N/A

Freedom of Choice:

Services:

Case management, nursing services, home health aide services, speech, occupational and physical therapy, respite care, durable medical equipment home mobility aids, child day health care and personal care services.

Eligibility:

Categorically needy, optional categorically needy and medically needy, blind, or disabled children, under age 19 and AFDC related children under age 19.

Reimbursement Provisions (if different from approved State Plan Methodology):

---

Signature of State Medicaid Director  
13-52

WAIVERS OF STATE PLAN PROVISIONS

State: North Carolina

Type of Waiver

- 1915(b)(1)- Case Management System
- 1915(b)(2)- Locality as a Central Broker
- 1915(b)(3)- Sharing of Cost Savings (through:  
Additional Services  
Elimination of Copayments
- 1915(b)(4)- Restriction of Freedom of Choice
- 1915(c) -  Home and Community-Based Services Waiver (non-model format).  
-  Home and Community-Based Services Waiver (model format).
- 1916(a)(3) and/or (b)(3) - Nominality of Copayments

Title of Waiver and Brief Description

Home and Community-Based Waiver for Mentally Retarded and Developmentally Disabled.

Approval Date: 2/22/83 Renewal Date s)..

Effective Date: 7/1/83

Specific State Plan Provisions Waived and Corresponding Plan Section(s):

Comparability: Section 1902(a)(10)

Statewideness: Section 1902(a)(1)

Freedom of Choice:

Services:

Case management, homemaker services, home health aide, personal care services, adult day health, personal habilitation services, respite care, home mobility aids and durable equipment.

Eligibility:

Mentally retarded Medicaid recipients who would otherwise require institutional care.

Reimbursement Provisions (if different from approved State Plan Methodology):

---

Signature of State Medicaid Director

WAIVERS OF STATE PLAN PROVISIONS

State: North Carolina

Type of Waiver

- 1915(b)(1)- Case Management System
- 1915(b)(2)- Locality as a Central Broker
- 1915(b)(3)- Sharing of Cost Savings (through:)
  - Additional Services
  - Elimination of Copayments
- 1915(b)(4)- Restriction of Freedom of Choice
- 1915(c)- **X** Home and Community-Based Services Waiver (non-model format).
  - Home and Community-Based Services Waiver (model format).
- 1916(a)(3) and/or (b)(3)-Nominality of Copayments

Title of Waiver and Brief Description:

Home and Community-Based Waiver for the Disabled and Elderly.

Approval Date: 10/1/82                      Renewal Date(s): 10/3/85

Effective Date: 7/1/82                              Effective 9/29/85

Specific State Plan Provisions Waived and Corresponding Plan Section(s):

Comparability: Section 1902(a)(10)

Statewideness: Section 1902(a)(1)

Freedom of Choice:

Services:

Screening, case management, homemaker services, chore services, adult day care, respite care, meals on wheels, home mobility aids, telephone alert and supplies.

Eligibility:

Elderly and disabled adults who are eligible Medicaid recipients.

Reimbursement Provisions (if different from approved State Plan Methodology):

\_\_\_\_\_  
Signature of State Medicaid Director



Revision: HCFA-PM-91-4 (BPD)  
AUGUST 1991

OMB No. 0938

STATE PLAN UNDER TITLE XIX OF THE SOCIAL SECURITY ACT  
MEDICAL ASSISTANCE PROGRAM

State/Territory: North Carolina

---

Citation As a condition for receipt of Federal funds  
under title XIX of the Social Security Act, the

42 CFR  
430.10

Department of Health and Human Services  
(Single State Agency)

submits the following State plan for the medical assistance program, and hereby agrees to administer the program in accordance with the provisions of this State plan, the requirement of titles XI and XIX of the Act, and all applicable Federal regulations and other official issuances of the Department.

---

TN No. 00-03

Supersedes

Approval Date Aug 02.2000

Effective Date 04/01/00

TN No. 92-01

HCFA ID: 7982E

Revision: HCFA-AT-80-38 (BPP)  
May 22, 1980

State North Carolina

SECTION 1 SINGLE STATE AGENCY ORGANIZATION

Citation  
42 CFR 431.10  
AT-79-29

1.1 Designation and Authority

(a) The Department of Health and Human Services is the single State agency designated to administer or supervise the administration of the Medicaid program under title XIX of the Social Security Act. (All references in this plan to "the Medicaid agency" mean the agency named in this paragraph.)

ATTACHMENT 1.1-A is a certification signed by the State Attorney General identifying the single State agency and citing the legal authority under which it administers or supervises administration of the program.

---

TN #00-03  
Supersedes  
TN #76-39

Approval Date Aug 02 2000

Effective Date 04/01/00

Revision: HCFA-AT-80-38 (BPP)  
May 22, 1980

State North Carolina

---

Citation  
Sec. 1902(a)  
of the Act

1.1(b) The State agency that administered or supervised the administration of the plan approved under title X of the Act as of January 1, 1965, has been separately designated to administer or supervise the administration of that part of this plan which relates to blind individuals.

Yes. The State agency so designated is

\_\_\_\_\_

\_\_\_\_\_.  
This agency has a separate plan covering that portion of the State plan under title XIX for which it is responsible.

Not applicable. The entire plan under title XIX is administered or supervised by the State agency named in paragraph 1.1(a).

---

TN #76-39  
Supersedes  
TN # \_\_\_\_\_

Approval Date 11/18/76

Effective Date 12/3/76

Revision: HCFA-AT-80-38 (BPP)  
May 22, 1980

State North Carolina

---

Citation  
Intergovernmental  
Cooperation Act  
of 1968

1.1 (c) Waivers of the single State agency requirement which are currently operative have been granted under authority of the Intergovernmental Cooperation Act of 1968.

- Yes. ATTACHMENT 1.1-B describes these waivers and the approved alternative organizational arrangements.
- Not applicable. Waivers are no longer in effect.
- Not applicable. No waivers have ever been granted.

---

TN # 12-007  
Supersedes  
TN # 76-39

Approval Date: 12-27-12

Effective Date 07/01/2012

Revision: HCFA-AT-80-38 (BPP)  
May 22, 1980

State North Carolina

---

Citation

42 CFR 431.10  
AT-79-29

1.1(d)

— The agency named in paragraph 1.1(a) has responsibility for all determinations of eligibility for Medicaid under this plan.

x Determinations of eligibility for Medicaid under this plan are made by the agency(ies) specified in ATTACHMENT 2.2-A. There is a written agreement between the agency named in paragraph 1.1(a) and other agency(ies) making such determinations for specific groups covered under this plan. The agreement defines the relationships and respective responsibilities of the agencies

---

TN #94-36  
Supersedes  
TN #76-39

Approval Date 5/18/95

Effective Date 1/1/95

Revision: HCFA-AT-80-38 (BPP)  
May 22, 1980

State North Carolina

---

Citation

42 CFR 431.10  
AT-79-29

- 1.1(e) All other provisions of this plan are administered by the Medicaid agency except for those functions for which **final authority has been granted to a Professional Standards Review Organization under title XI of the Act.**
  
- (f) All other requirements of 42 CFR 431.10 are met.

---

TN #76-39  
Supersedes  
TN # \_\_\_\_\_

Approval Date **11/18/76**

Effective Date 12/3/76

Revision: HCFA-AT-80-38 (BPP)  
May 22, 1980

State North Carolina

Citation  
42 CFR 431.11  
AT-79-29

1.2 Organization for Administration

- (a) ATTACHMENT 1.2-A contains a description of the organization and functions of the Medicaid agency and an organization chart of the agency.
- (b) Within the State agency, the \_\_\_\_\_ Division of Medical Assistance has been designated as the medical assistance unit. ATTACHMENT 1.2-B contains a description of the organization and functions of the medical assistance unit and an organization chart of the unit.
- (c) ATTACHMENT 1.2-C contains a description of the kinds and numbers of professional medical personnel and supporting staff used in the administration of the plan and their responsibilities.
- (d) Eligibility determinations are made by State or local staff of an agency other than the agency named in paragraph 1.1(a). ATTACHMENT 1.2-D contains a description of the staff designated to make such determinations and the functions they will perform.
- X Not applicable. Only staff of the agency named in paragraph 1.1(a) make such determinations.

TN #79-11  
Supersedes  
TN # \_\_\_\_\_

Approval Date 9/10/79

Effective Date 7/1/79

Revision: HCFA-AT-80-38 (BPP)  
May 22, 1980

State North Carolina

---

Citation  
42 CFR  
431.50(b)  
AT-79-29

1.3 Statewide Operation

The plan is in operation on a Statewide basis in accordance with all requirements of 42 CFR 431.50.

The plan is State administered.

The plan is administered by the political subdivisions of the State and is mandatory on them.

---

TN #79-11  
Supersedes  
TN # \_\_\_\_\_

Approval Date 9/10/79

Effective Date 7/1/79



Revision: HCFA-AT-80-38 (BPP)  
May 22, 1980

State North Carolina

---

Citation  
42 CFR  
431.12(b)  
AT-78-90

1.4 State Medical Care Advisory Committee

There is an advisory committee to the Medicaid agency director on health and medical care services established in accordance with and meeting all the requirements of 42 CFR 431.12.

42 CFR 438.104

X The State enrolls recipients in MCO, PIHP, PAHP, and/or PCCM programs. The State assures that it complies with 42 CFR 438.104(c) to consult with the Medical Care Advisory Committee in the review of marketing materials.

---

TN #03-04  
Supersedes  
TN #74-34

Approval Date **NOV 18 2003**

Effective Date **8/13/2003**

## STATE PLAN UNDER TITLE XIX OF THE SOCIAL SECURITY ACT

State: North Carolina**Tribal Consultation**

---

Requirements and NC Plan

Section 1902(a)(73) of the Social Security Act (the Act) requires a State in which one or more Indian Health Programs or Urban Indian Organizations furnish health care services to establish a process for the State Medicaid agency to seek advice on a regular, ongoing basis from designees of Indian health programs, whether operated by the Indian Health Service (IHS), Tribes or Tribal organizations under the Indian Self-Determination and Education Assistance Act (ISDEAA), or Urban Indian Organizations under the Indian Health Care Improvement Act (IHCIA). Section 2107(e)(I) of the Act was also amended to apply these requirements to the Children's Health Insurance Program (CHIP). Consultation is required concerning Medicaid and CHIP matters having a direct impact on Indian health programs and Urban Indian organizations.

North Carolina will use the process identified in this section to seek advice on a regular, ongoing basis from federally-recognized tribes, Indian Health Programs and Urban Indian Organizations on matters related to Medicaid and CHIP programs and for consultation on all State Plan Amendments (SPA), waiver proposals, waiver extensions, waiver amendments, waiver renewals and proposals for demonstration projects prior to submission to the Centers for Medicare and Medicaid Services (CMS).

- A. The State will assure nomination to the NC Department of Health and Human Services (DHHS) Secretary for appointment of a representative of the Eastern Band of the Cherokee Indians to the Medical Care Advisory Committee. This advisory committee meets at least quarterly to review activities of the Division of Medical Assistance and provide recommendations and advice on current and future policy initiatives and pending changes to the Medicaid program.
- B. The NC DHHS Secretary will appoint a designated liaison in the Office of the Secretary to facilitate the intergovernmental relationship between the Department

## STATE PLAN UNDER TITLE XIX OF THE SOCIAL SECURITY ACT

State: North Carolina**Tribal Consultation**

---

and the Eastern Band of the Cherokee Indians, and any other Indian Health Program meeting the definition under the Act to assure compliance with the federal provisions for consultation and to expedite communication and between these entities.

To meet the requirements for timely notification of the Tribe for SPA/Waiver submissions or other policy changes that arise between MCAC Quarterly meetings the Medicaid Agency will notify the Tribe in writing of these pending changes. The State will use this combined approach to seek the Tribe's advice and input on matters related to the changes to Medicaid and CHIP programs.

- a. If requested by the tribe in follow up to these notifications, the State will meet quarterly or as needed in face-to-face meetings or via conference calls with representatives of the Eastern Band of the Cherokee Indians and Division of Medical Assistance key leadership staff to discuss any items of importance to the parties. These discussions may include provision of additional information or the Tribe's input on pending changes, update on current status of ongoing initiatives, and ongoing assessment of the consultation process to assure efficiency and effectiveness of the consultative activities. These meetings will provide a forum for the Tribe to share and discuss concerns regarding policy and the consultation process with the decision-makers in the Medicaid Agency.
- b. Appoint Medicaid Assistant Directors as primary contacts and positions responsible for assuring notification of all pending SPA/Waiver or policy changes and inclusion of federally recognized Tribal representatives on workgroups and planning initiatives. If a SPA or waiver submission to CMS will occur outside of the scheduled MCAC quarterly meeting timeframe, the DMA will notify EBCI in writing 60 days prior to submission to CMS, and EBCI will have 30 days to respond.
- c. Invite, on a routine basis, the Senior Health Official of the Eastern Band of Cherokee Indians or his/her designee to participate in policy planning (SPA, NC Administrative Code, Clinical Coverage), waiver development, program planning, and development workgroups and initiatives.
- d. Provide federally recognized Tribal programs with a current list of Division contacts for Medicaid Administration to include Director, Deputy Directors, Assistant Directors, and Medical and Dental Directors to facilitate requests for technical assistance, policy clarification and problem resolution.

TN #10-038  
Supersedes  
TN NEW

Approval Date: 03-17-11Effective Date 01-01-2011

STATE PLAN UNDER TITLE XIX OF THE SOCIAL SECURITY ACT

State: North Carolina

**Tribal Consultation**

---

- e. Medicaid Agency Administration will make an annual onsite visit to federally recognized Tribal Programs and/or to facilitate collaboration and understanding among all parties.

Tribal Consultation Development Process

The consultative process that occurred for the development of this State Plan Amendment was based on a series of previous visits, contacts and discussions between the Eastern Band of the Cherokee Indians Health Services and the North Carolina Department of Health and Human Services. Discussions had occurred under former DHHS Secretary Odom relating to consultation. Discussions were re-initiated on April 28, 2010, during an on site visit to the Cherokee Health Services Program by DHHS Secretary Lanier Cansler and Michael Watson, Deputy Secretary. The need for a designated liaison in the Office of the Secretary to facilitate the Intergovernmental Relationship was discussed.

The Medicaid Agency has held many and varied calls with Cherokee Health Services regarding SPAs. A second site visit to the Cherokee Health Services program was made by the DMA Chief for Behavioral Health and clinical staff in August 2010. The purpose of the visit was to share information related to Medicaid program changes and representation on the MCAC; as well as to give the State an in-person learning experience with Cherokee Health Services and the Chief of the Eastern Band of the Cherokee Indians.

In preparation for the change in Medicaid Agency operations and the development of the Tribal Consultation SPA, DMA sent the Chief of the Behavioral Health Unit to September 2010 Indian Health Services Conference in Sioux Falls, South Dakota. This provided an opportunity to gain an understanding of the consultative process and of the provisions in the Indian Health Services Reauthorization Act.

TN #10-038  
Supersedes  
TN NEW

Approval Date: 03-17-11

Effective Date 01-01-2011

STATE PLAN UNDER TITLE XIX OF THE SOCIAL SECURITY ACT

State: North Carolina

**Tribal Consultation**

---

In November 2010, DMA began working to schedule a meeting to consult with Eastern Band of the Cherokee Indians (EBCI) Tribal leadership regarding the details of the consultation process. A conference call was established for December 7, 2010. Those participating on the call are as follows:

Eastern Band of the Cherokee Nation

- Vickie Bradley, Deputy Health Officer of Eastern Band of Cherokee Indians
- Trina Owle, Business Director, EBCI Health and Medical Division
- Casey Cooper, CEO of Cherokee Indian Hospital
- Jonathan Dando, Director of Business Office, Cherokee Indian Hospital

NC DHHS: Division of Medical Assistance

- Tara Larson, Chief Clinical Operating Officer
- Steve Owen, Chief Financial Operating Officer
- John Alexander, Acting Assistant Director, Budget Management
- Roger Barnes, Assistant Director, Finance Management
- Randall Best, MD, Medical Director
- Clarence Ervin, Assistant Director, Program Integrity
- Catharine Goldsmith, Chief, Behavioral Health Unit
- Kris Horton, CMS Liaison
- Teresa Smith, State Plan Coordinator
- Craig Umstead, Manager, Provider Services
- Betty West, for Managed Care Assistant Director

The Tribal Consultation SPA is the result of the December 7, 2010 conference call. All parties are committed to the provisions included in this amendment, to working together to assure open channels of communication, to facilitating problem resolution and to inclusion of federally recognized Tribal programs and/or Indian Health Service facilities in the initial phases of policy, program and waiver development, and changes in the Medicaid and CHIP State Plans.

TN #10-038

Supersedes

TN NEW

Approval Date: 03-17-11

Effective Date 01-01-2011

Revision: HCFA-PM-94-3 (MB)  
 APRIL 1994  
 State/Territory: NORTH CAROLINA

Citation 1.5 Pediatric Immunization Program

- 1928 of the Act
1. The State has implemented a program for the distribution of pediatric vaccines to program- registered providers for the immunization of federally vaccine-eligible children in accordance with section 1928 as indicated below.
    - a. The State program will provide each vaccine-eligible child with medically appropriate vaccines according to the schedule developed by the Advisory Committee on Immunization Practices and without charge for the vaccines.
    - b. The State will outreach and encourage a variety of providers to participate in the program and to administer vaccines in multiple settings, e.g., private health care providers, providers that receive funds under Title V of the Indian Health Care Improvement Act, health programs or facilities operated by Indian tribes, and maintain a list of program-registered providers.
    - c. With respect to any population of vaccine-eligible children a substantial portion of whose parents have limited ability to speak the English language, the State will identify program-registered providers who are able to communicate with this vaccine-eligible population in the language and cultural context which is most appropriate.
    - d. The State will instruct program-registered providers to determine eligibility in accordance with section 1928(b) and (h) of the Social Security Act.
    - e. The State will assure that no program-registered provider will charge more for the administration of the vaccine than the regional maximum established by the Secretary. The State will inform program-registered providers of the maximum fee for the administration of vaccines.
    - f. The State will assure that no vaccine-eligible child is denied vaccines because of an inability to pay an administration fee.
    - g. Except as authorized under section 1915(b) of the Social Security Act or as permitted by the Secretary to prevent fraud or abuse, the State will not impose any additional qualifications or conditions, in addition to those indicated above, in order for a provider to qualify as a program-registered provider.

TN No. 94-35  
 Supersedes  
 TN No. new

Approval Date FEB 03 1995

Effective Date October 1, 1994

Revision: HCFA-PM-94-3 (MB)  
APRIL 1994  
State/Territory: NORTH CAROLINA

Citation

1928 of the Act

2. The State has not modified or repealed any Immunization Law in effect as of May 1, 1993 to reduce the amount of health insurance coverage of pediatric vaccines.
3. The State Medicaid Agency has coordinated with the State Public Health Agency in the completion of this preprint page.
4. The State agency with overall responsibility for the implementation and enforcement of the provisions of section 1928 is:

State Medicaid Agency

State Public Health Agency

Citation:  
1932 of the  
Social Security Act

1.6 State Option to Use Managed Care

Complaints usually fall into one of the following five categories:

1. contract violations/program policy
2. professional conduct – general
3. professional conduct – physical, sexual or substance abuse
4. quality of care
5. program fraud/abuse

Enrollees who complete and sign the complaint form will receive a letter acknowledging receipt from the Quality Management Unit within 7 days of receipt. Upon receipt of a complaint, it is routed to the appropriate Managed Care staff person for action and resolution. Enrollees will not be notified of the outcome of the complaint due to confidentiality policies.

### **III. ASSURANCES AND COMPLIANCE WITH THE STATUTE AND REGULATIONS**

The State plan program meets all the applicable requirements of:

- Section 1903 (m) of the Act, for MCOs and MCO contracts.
- Section 1905 (t) of the Act for PCCMs and PCCM contracts.
- Section 1932 (including Section (a)(1)(A)) of the Act, for the State's option to limit freedom of choice by requiring recipients to receive their benefits through managed care entities.
- 42 CFR 431.51 regarding freedom of choice for family planning services and supplies as defined in Section 1905 (a)(4)(C)
- 42 CFR 438 for MCOs and PCCMs.
- 42 CFR 434.6 of the general requirements for contracts.



Citation:  
1932 of the  
Social Security Act

1.6 State Option to Use Managed Care

- 42 CFR 438.6 (c) of the regulations for payments under any risk contracts.
- 42 CFR 447.362 for payments under any nonrisk contracts.
- 45 CFR part 74 for procurement of contracts.

#### **IV. ELIGIBLE GROUPS**

A. list all eligible groups that will be enrolled on a mandatory basis

With the exception of the populations listed in IV.B, recipients in the following aid categories will be required to enroll in one of the managed care programs described above:

- Work First for Family Assistance (formerly AFDC)
- Family and Children's Medicaid without Medicaid deductibles (formerly AFDC-related)
- Medicaid for the Blind and Disabled (MAB, MAD, MSB)
- Residents of Adult Care Homes (SAD)
- Qualified Alien

Children under age 19 identified as Children with Special Health Care Needs, dual eligibles, and Indians who are members of a Federally recognized tribes are exempt from mandatory enrollment.

TN No. 03-04 Approval Date: **NOV 18 2003**

Eff. Date: 8/13/2003

Supersedes  
TN No. 01-04

Citation:  
1932 of the  
Social Security Act

1.6 State Option to Use Managed Care

1. Children under the age of 19 years who are foster care or other out-of-the-home placement.

X The State will allow these individuals to voluntarily enroll in the managed care program.

2. Children under the age of 19 years who are receiving foster care or adoption assistance under title IV-E

X The State will allow these individuals to voluntarily enroll in the managed care program.

Children under the age of 19 years who are receiving services through a family-centered, community based, coordinated care system that receives grant funds under section 501(a)(1)(D) of Title V, and is defined by the state in terms of either program participation or special health care needs.

X The State will allow these individuals to voluntarily enroll in the managed care program.

- c. list all other groups that ARE PERMITTED TO ENROLL on a voluntary basis

Community Alternative Program (CAP) Enrollees are allowed to enroll in Carolina ACCESS and ACCESS II.

1. Is the State's definition of these children in terms of program participation or special health care needs?

The State defines these children in terms of special health care needs and program participation in Development Evaluation Center (DEC) and Child Special Health Services (CSHS).

STATE PLAN UNDER TITLE XIX OF THE SOCIAL SECURITY ACT

STATE: North Carolina

9j

Citation:

1932 of the  
Social Security Act

1.6 State Option to Use Managed Care

2. Does the scope of these Title V services include services received through a family-centered, community-based, coordinated care system?  
Title V program participants are identified as those receiving DEC services and CSHS.

3. How does the State identify the following groups of children who are exempt from mandatory enrollment:

- a. Children under 19 years of age who are eligible for SSI under Title XVI;

The State identifies this group by Medicaid eligibility category of assistance.

- b. Children under 19 years of age who are eligible under section 1902 (e)(3) of the Act;

The State does not enroll this population in the managed care programs.

- c. Children under 19 years of age who are receiving foster care or adoption assistance under title IV-E of the Act.

The State identifies this group by the Medicaid eligibility category of assistance.

4. What is the State's process for allowing children to request an exemption based on the special needs criteria as defined in the State Plan if they are not initially identified as exempt from mandatory enrollment?

Enrollment in a managed care program health care option is voluntary for Children with Special Health Care Needs (CSHCN).

TN No. 03-04 Approval Date: **NOV 18 2003**  
Supersedes  
TN No. NEW

Eff. Date: 8/13/2003

Citation:  
1932 of the  
Social Security Act

1.6 State Option to Use Managed Care

b. There is no eligibility category group designated for the Native American population; they are eligible for Medicaid under existing program aid categories. When a Native American applies for Medicaid, he is automatically exempted from enrollment into managed care based on his membership in a federally recognized tribe and not on his eligibility group.

E. List other populations (not previously mentioned) who are exempt from mandatory enrollment.

There are no other exempt populations (not previously mentioned).

## V. ENROLLMENT PROCESS

### a. definitions

An existing provider-recipient relationship is one in which the provider was the main source of Medicaid services for the recipient during the previous year. This may be established through State records of previous managed care enrollment or fee-for-service experience, or through contact with the recipient.

A provider is considered to have "traditionally served" Medicaid recipients if it has experience in serving the Medicaid population.

### b. state process for enrollment by default

1. Describe how the state's default enrollment process will preserve:

- a. the existing provider-recipient relationship;
- b. the relationship with providers that have traditionally served Medicaid recipients;

TN No. 03-04  
Supersedes  
TN No. NEW

Approval Date: NOV 18 2003

Eff. Date: 8/13/2003

STATE PLAN UNDER TITLE XIX OF THE SOCIAL SECURITY ACT

STATE: North Carolina

9p

Citation:  
1932 of the  
Social Security Act

1.6 State Option to Use Managed Care

1. The State Plan program assures that, per the choice requirements in 42 CFR 438.52, Medicaid recipients enrolled in either an MCO or PCCM model will have a choice of at least two entities unless the area is considered rural as defined in 42 CFR 412.62 (f)(1)(ii).

X The State Plan program applies the rural exception to choice requirements of 42 CFR 438.52 (a) for MCOs and PCCMs. (Place check mark to indicate state's affirmation.)

2. The State plan program will only limit enrollment into a single HIO, if and only if the HIO is one of the entities described in section 1932 (a)(3) (C) of the Act; and the recipient has a choice of at least two primary care providers within the entity. (California only.)

d. disenrollment

1. The State Plan program assures that beneficiary requests for disenrollment (with and without cause) will be permitted in accordance with 42 CFR 438.56 (c).

The State assures that beneficiaries will be permitted to disenroll from a managed care plan or change Carolina ACCESS/ACCESS II PCPs on a month to month basis. However, the recipient must select another managed care plan option for health care services, if the recipient is in one of the mandatory eligibility categories for enrollment. The county DSS is responsible for processing an enrollee's change request. Changes are effective the first day of the month following the change in the State eligibility system.

2. What are the additional circumstances of "cause" for disenrollment? (If any.)

**VI. INFORMATION REQUIREMENTS FOR BENEFICIARIES**

The State Plan program assures that its plan is in compliance with 42 CFR 438.10(i) for information requirements specific to MCOs and PCCM programs operated under section 1932 (a)(1)(A) state plan amendments.

TN No. 03-04

Approval Date: NOV 18 2003

Eff. Date: 8/13/2003

Supersedes

TN No. NEW

**SUPERSEDING PAGES OF STATE PLAN MATERIAL**

**TRANSMITTAL NUMBER:**

**13-0002 MM2**

**STATE:**

**North Carolina**

**PAGE NUMBER OF THE PLAN  
SECTION OR ATTACHMENT:**

S94

**PAGE NUMBER OF THE SUPERSEDED PLAN  
SECTION OR ATTACHMENT (*If Applicable*):**

Section 2, Page 10, Section 2.1(a). TN#92-01, effective date; 01/01/92, approved: 10/21/92

Section 2, Page 11a, Section 2.1a(d). TN#91-35, effective date: 07/01/91, approved 10/24/91



# Medicaid

OMB Control Number 0938-1148  
OMB Expiration date: 10/31/2014

## General Eligibility Requirements Eligibility Process

**S94**

42 CFR 435, Subpart J and Subpart M

### Eligibility Process

- The state meets all the requirements of 42 CFR 435, Subpart J for processing applications, determining and verifying eligibility, and furnishing Medicaid.

### Application Processing

Indicate which application the agency uses for individuals applying for coverage who may be eligible based on the applicable modified adjusted gross income standard.

- The single, streamlined application for all insurance affordability programs, developed by the Secretary in accordance with section 1413(b)(1)(A) of the Affordable Care Act
- An alternative single, streamlined application developed by the state in accordance with section 1413(b)(1)(B) of the Affordable Care Act and approved by the Secretary, which may be no more burdensome than the streamlined application developed by the Secretary.

**An attachment is submitted.**

- An alternative application used to apply for multiple human service programs approved by the Secretary, provided that the agency makes readily available the single or alternative application used only for insurance affordability programs to individuals seeking assistance only through such programs.

**An attachment is submitted.**

Indicate which application the agency uses for individuals applying for coverage who may be eligible on a basis other than the applicable modified adjusted gross income standard:

- The single, streamlined application developed by the Secretary or one of the alternate forms developed by the state and approved by the Secretary, and supplemental forms to collect additional information needed to determine eligibility on such other basis, submitted to the Secretary.

**An attachment is submitted.**

- An application designed specifically to determine eligibility on a basis other than the applicable MAGI standard which minimizes the burden on applicants, submitted to the Secretary.

**An attachment is submitted.**

The agency's procedures permit an individual, or authorized person acting on behalf of the individual, to submit an application via the internet website described in 42 CFR 435.1200(f), by telephone, via mail, and in person.

The agency also accepts applications by other electronic means:

Yes  No



# Medicaid

Indicate the other electronic means below:

	Name of method	Description	
<b>+</b>	Facsimile		<b>X</b>

- The agency has procedures to take applications, assist applicants and perform initial processing of applications for the eligibility groups listed below at locations other than those used for the receipt and processing of applications for the title IV-A program, including Federally-qualified health centers and disproportionate share hospitals.

Parents and Other Caretaker  
 Relatives Pregnant Women  
 Infants and Children under Age 19

### Redetermination Processing

- Redeterminations of eligibility for individuals whose financial eligibility is based on the applicable modified adjusted gross income standard are performed as follows, consistent with 42 CFR 435.916:
  - Once every 12 months
  - Without requiring information from the individual if able to do so based on reliable information contained in the individual's account or other more current information available to the agency
  - If the agency cannot determine eligibility solely on the basis of the information available to it, or otherwise needs additional information to complete the redetermination, it provides the individual with a pre-populated renewal form containing the information already available.
  - Redeterminations of eligibility for individuals whose financial eligibility is not based on the applicable modified adjusted gross income standard are performed, consistent with 42 CFR 435.916 (check all that apply):
    - Once every 12 months
    - Once every 6 months
    - Other, more often than once every 12 months

### Coordination of Eligibility and Enrollment

- The state meets all the requirements of 42 CFR 435, Subpart M relative to coordination of eligibility and enrollment between Medicaid, CHIP, Exchanges and other insurance affordability programs. The single state agency has entered into agreements with the Exchange and with other agencies administering insurance affordability programs.

#### PRA Disclosure Statement

According to the Paperwork Reduction Act of 1995, no persons are required to respond to a collection of information unless it displays a valid OMB control number. The valid OMB control number for this information collection is 0938-1148. The time required to complete this information collection is estimated to average 40 hours per response, including the time to review instructions, search existing data resources, gather the data needed, and complete and review the information collection. If you have comments concerning the accuracy of the time estimate(s) or suggestions for improving this form, please write to: CMS, 7500 Security Boulevard, Attn: PRA Reports Clearance Officer, Mail Stop C4-26-05, Baltimore, Maryland 21244-1850.



**USE OF THE ALTERNATIVE SINGLE STREAMLINED APPLICATION**

Paper Application

Online Application

TRANSMITTAL NUMBER:

NC 13-0002-MM2

STATE:

North Carolina

Through February 1, 2014, the state is using an interim alternative single streamlined application. After February 1, 2014 the state will use a revised alternative single streamlined application. The revised application will address the issues outlined in the CMS letter, which was issued with the approval of this state plan amendment, concerning the state's application. The revised application will be incorporated by reference into the state plan.

---

TN No: 13-0002-MM2  
North Carolina

Approval Date: 01-16-14

Effective Date: 01-01-14

**USE OF THE ALTERNATIVE SINGLE STREAMLINED APPLICATION**

Paper Application

Online Application

TRANSMITTAL NUMBER:

NC 13-0002-MM2

STATE:

North Carolina

Through June 1, 2014 the state is using an interim alternative single streamlined application. After June 1, 2014 the state will use a revised alternative single streamlined application. The revised application will address the issues outlined in the CMS letter, which was issued with the approval of this state plan amendment, concerning the state's application. The revised application will be incorporated by reference into the state plan.

---

TN No: 13-0002-MM2

Approval Date: 01-16-14

Effective Date: 01-01-14

North Carolina

Revision: HCFA-PM-93-2 (MB)  
MARCH 1993

State: North Carolina

Citation

42 CFR  
435.914  
of the Act

2.1 (b)(1) Except as provided in items  
2.1(b)(2) and (3) below, 1902(a)(34) individuals are entitled to Medicaid services under the plan during the three months preceding the month of application, if they were, or on application would have been, eligible. The effective date if prospective and retroactive eligibility is specified in ATTACHMENT 2.6-A.

1902(e)(8) and  
1905(a) of the  
Act

(2) For individuals who are eligible for Medicare cost-sharing expenses as qualified Medicare beneficiaries under Section 1902(a)(10)(E)(i) of the Act, coverage is available for services furnished after the end of the month in which the individual is first determined to be a qualified Medicare beneficiary. ATTACHMENT 2.6-A specifies the requirements for determination of eligibility for this group.

1902(a)(47) and  
1920 of the Act

x (3) Pregnant women are entitled to ambulatory prenatal care under the plan during a presumptive eligibility period in accordance with section 1920 of the Act ATTACHMENT 2.6-A specifies the requirements for determination of eligibility for this group.

---

TN No. 03-04  
Supersedes  
TN No. 93-03

Approval Date: NOV 18 2003

Effective Date 8/13/2003

Revision: HCFA-PM-91-4 (BPD)  
AUGUST 1991

OMB No.: 0938-

State: North Carolina

Citation  
42 CFR  
435.10

2.2 Coverage and Conditions of Eligibility

Medicaid is available to the groups specified in ATTACHMENT 2.2-A.

Mandatory categorically needy and other required special groups only.

Mandatory categorically needy, other required special groups, and the medically needy, but no other optional groups.

Mandatory categorically needy, other required special groups, and specified optional groups.

Mandatory categorically needy, other required special groups, specified optional groups, and the medically needy.

The conditions of eligibility that must be met are specified in ATTACHMENT 2.6-A.

All applicable requirements of 42 CFR Part 435 and sections 1902(a)(10)(A)(i)(IV), (V), and (VI), 1902(a)(10)(A)(ii)(XI), 1902(a)(10)(E), 1902(l) and (m), 1905(p), (q) and (s), 1920, and 1925 of the Act are met.

---

TN No. 92-01  
Supersedes  
TN No. 87-5

Approval Date 10-21-92

Effective Date 1/1/92  
HCFA ID: 7982E

Revision: HCFA-PM-87-4 (BERC)  
MARCH 1987

OMB No.: 0938-0193

State: North Carolina

---

Citation

435.10 and  
435.403, and  
1902(b) of the  
Act, P.L. 99-272  
(Section 9529)  
and P.L. 99-509  
(Section 9405)

2.3 Residence

Medicaid is furnished to eligible individuals who are residents of the State under 42 CFR 435.403, regardless of whether or not the individuals maintain the residence permanently or maintain it at a fixed address

---

TN No. 87-5  
Supersedes  
TN No. 86-19

Approval Date **JUL 23 1987**

Effective Date 4/1/87  
HCFA ID: 1006P/0010P

Revision: HCFA-PM-87-4 (BERC)  
MARCH 1987

OMB No.: 0938-0193

State: North Carolina

Citation

42 CFR 435.530(b)  
42 CFR 435.531  
AT-78-90  
AT-79-29

2.4 Blindness

All of the requirements of 42 CFR 435.530 and 42 CFR 435.531 are met. The more restrictive definition of blindness in terms of ophthalmic measurement used in this plan is specified in ATTACHMENT 2.2-A.

---

TN No. 87-5

Supersedes

TN No. 77-12

Approval Date JUL 23 1987

Effective Date 4/1/87

HCFA ID: 1006P/0010P

Revision: HCFA-PM-91-4 (BPD)  
AUGUST 1991

OMB No. 0938-

State: North Carolina

Citation  
42 CFR  
435.121,  
435.540(b)

2.5 Disability

All of the requirements of 42 CFR 435.540 and 435.541 are met. The State uses the same definition of disability used under the SSI program unless a more restrictive definition of disability is specified in Item A.13.b. of ATTACHMENT 2.2-A of this plan.

This includes the option set forth in 42 USC 1396(v) for making independent disability determinations subject to final administrative determinations on such applications by SSA by using the definition of disability in 20 CFR 416.901 et seq. of the Act as reflected in 42 CFR 435.541.

---

TN No. 03-07  
Supersedes  
TN No. 92-01

Approval Date 9/10/03

Effective Date 7/1/2003

HCFA ID: 7982E

Revision: HCFA-PM-92-1 (MB)  
FEBRUARY 1992

State: North Carolina

Citation(s) 2.6 Financial Eligibility

42 CFR  
435.10 and  
Subparts G & H  
1902(a)(10)(A)(i)  
(III), (IV), (V),  
(VI), and (VII),  
1902(a)(10)(A)(ii)  
(IX), 1902(a)(10)  
(A)(ii)(x), 1902  
(a)(10)(C),  
1902(f), 1902(l)  
and (m),  
1905(p) and (s),  
1902(r)(2),  
and 1920

(a) The financial eligibility conditions  
for Medicaid-only eligibility groups  
and for persons deemed to be cash  
assistance recipients are described  
in ATTACHMENT 2.6-A.

---

TN No. 92-01  
Supersedes  
TN No. 89-03

Approval Date 10-21-92

Effective Date 1-1-92



Revision: HCFA-PM-86-20 (BERC)  
SEPTEMBER 1986

OMB-No. 0938-0193

State/Territory: North Carolina

Citation                      2.7    Medicaid Furnished out of State

431.52 and  
1902(b) of the  
Act. P.L. 99-272  
(Section 9529)

Medicaid is furnished under the conditions specified in 42 CFR 431.52 to an eligible individual who is a resident of the State while the individual is in another State, to the same extent that Medicaid is furnished to residents in the State.

---

TN No. 86-19  
Supersedes  
TN No. 82-14

Approval Date JUL 7 1987

Effective Date 10-1-86  
HCFA ID: 0053C/0061E

Revision: HCFA-PM-91- 4 (BPD) OMB No: 0938-  
AUGUST 1991

State/Territory: North Carolina

SECTION 3 - SERVICES: GENERAL PROVISIONS

Citation 3.1 Amount, Duration, and Scope of Services

42 CFR (a) Medicaid is provided in accordance with the  
Part 440, requirements of 42 CFR Part 440, Subpart B  
Subpart B and sections 1902(a), 1902(e), 1905(a),  
1902(a), 1902(e), 1905(a), 1905(p), 1915, 1920, and 1925 of the Act.  
1905(a), 1905(p),  
1915, 1920, and  
1925 of the Act (1) Categorically needy.

Services for the categorically needy are described below and in ATTACHMENT 3.1-A. These services include:

1902(a)(10)(A) and  
1905(a) of the Act

- (i) Each item or service listed in section 1905(a) (1) through (5) and (21) of the Act is provided as defined in 42 CFR Part 440,Subpart A, or, for EPSDT services, section 1905(r) and 42 CFR Part 441, Subpart B.
- (ii) Nurse-midwife services listed in section 1905(a)(17) of the Act, as defined in 42 CFR 440.165 are provided to the extent that nurse-midwives are authorized to practice under State law or regulation. Nurse-midwives are permitted to enter into independent provider agreements with the Medicaid agency without regard to whether the nurse-midwife is under the supervision of, or associated with, a physician or other health care provider.
- Not applicable. Nurse-midwives are not authorized to practice in this State.

TN No. 92-01  
Supersedes  
TN No. 87-5

Approval Date 10-21-92

Effective Date 1/1/92  
HCFA ID: 7982E

Revision: HCFA-PM-91- 4 (BPD)  
AUGUST 1991

OMB No.: 0938-

State/Territory: North Carolina

Citation

3.1(a)(1) Amount, Duration, and Scope of Services:  
Categorically Needy (Continued)

1902(e)(5) of  
the Act

(iii) Pregnancy- related, including family planning services, and postpartum services for a 60-day period (beginning on the day pregnancy ends) and any remaining days in the month in which the 60th day falls are provided to women who, while pregnant, were eligible for, applied for, and received medical assistance on the day the pregnancy ends.

X

(iv) Services for medical conditions that may complicate the pregnancy (other than pregnancy-related or postpartum services) are provided to pregnant women.

(F), 1902 (a) (10)  
(F) (VII)

(v) Services related to pregnancy (including prenatal, delivery, postpartum, and family planning services) and to other conditions that may complicate pregnancy are the same services provided to poverty level pregnant women eligible under the provision of sections 1902(a)(10)(A)(i)(IV) and 1902(a)(10)(A)(ii)(IX) of the Act.

---

TN No. 92-01  
Supersedes  
TN No. 87-18

Approval Date 10-21-92

Effective Date 1/1/92  
HCFA ID: 7982E

Revision: HCFA-PM-91- 4 (BPD)  
AUGUST 1991

OMB No. 0938-

State/Territory: North Carolina

Citation 3.1(a)(1) Amount, Duration, and Scope-of-Services:  
1902(a) Categorically Needy (Continued)  
(10)(D)

- (vi) Home health services are provided to individuals entitled to nursing facility services as indicated in item 3.1(b) of this plan.
- 1902(e)(7) of the Act (vii) Inpatient services that are being furnished to infants and children described in section 1902(l)(1)(B) through (D), or section 1905(n)(2) of the Act on the date the infant or child attains the maximum age for coverage under the approved State plan will continue until the end of the stay for which the inpatient services are furnished.
- 1902(e)(9) of the Act ventilator (viii) Respiratory care services are Act provided to dependent individuals as indicated in item 3.1(h) of this plan.
- 1902(a)(52) and Section 1925 of the Act (ix) Services are provided to families eligible under 1925 of the Act as indicated in item 3.5 of this plan.
- 1905(a)(26) and 1934 X (x) Program of All-Inclusive Care for the Elderly (PACE) services, as described and limited in Supplement 3 to Attachment 3.1-A.

ATTACHMENT 3.1-A identifies the medical and remedial services provided to the categorically needy. (Note: Other programs to be offered to Categorically Needy beneficiaries would specify all limitations on the amount, duration and scope of those services. As PACE provides services to the frail elderly population without such limitation, this is not applicable for this program. In addition, other programs to be offered to Categorically Needy beneficiaries would also list the additional coverage -that is in excess of established service limits- for pregnancy-related services for conditions that may complicate the pregnancy. As PACE is for the frail elderly population, this also is not applicable for this program.)

TN No.: 06-009  
Supersedes  
TN No.: 92-01

Approval Date: 12/04/06  
Effective Date: 01/01/07

Revision: HCFA-PM-91- 4 (BPD)  
AUGUST 1991

OMB No: 0938-

State/Territory: North Carolina

Citation

3.1 Amount, Duration, and Scope of Services (continued)

42 CFR,  
Part 440  
Subpart B

(a)(2) Medically needy.

x This State plan covers the medically  
needy The services described below and in  
ATTACHMENT 3.1-B are provided.

Services for the medically needy include:

1902(a)(10)(C)(iv)  
of the Act  
42 CFR 440.220

(i) If services in an institution for  
mental diseases (42 CFR 440.140 and  
440.160) or an intermediate care  
facility for the mentally retarded (or both) are  
provided to any medically needy group, then each  
medically needy group is provided either the  
services listed in section 1905(a)(1) through (5)  
and (17) of the Act, or seven of the services listed  
in section 1905(a)(1)through (20). The services are  
provided as defined in 42 CFR Part 440, Subpart  
A and in sections 1902, 1905, and 1915 of the Act.

— Not applicable with respect to  
nurse-midwife services under section  
1902(a)(17). Nurse-midwives are not  
authorized to practice in this State.

1902(e)(5) of  
the Act

(ii) Prenatal care and delivery services  
for pregnant women.

TN No. 92-01  
Supersedes  
TN No. 88-3

Approval Date 10-21-92

Effective Date 1/1/92  
HCFA ID: 7982E

Revision: HCFA-PM-91- 4 (BPD)  
AUGUST 1991

OMB No.: 0938-

State/Territory: North Carolina

Citation

3.1(a)(2) Amount, Duration, and Scope of Services:  
Medically Needy (Continued)

(iii) Pregnancy-related, including family planning services, and postpartum services for a 60-day period (beginning on the day the pregnancy ends) and any remaining days in the month in which the 60th day falls are provided to women who, while pregnant, were eligible for, applied for, and received medical assistance on the day the pregnancy ends.

(iv) Services for any other medical condition that may complicate the pregnancy (other than pregnancy related and postpartum services) are provided to pregnant women.

(v) Ambulatory services, as defined in ATTACHMENT 3.1-B, for recipients under age 18 and recipients entitled to institutional services

— Not applicable with respect to recipients entitled to institutional services; the plan does not cover those services for the medically needy.

(vi) Home health services to recipients entitled to nursing facility services as indicated in item 3.1(b) of this plan.

42 CFR 440.140 x (vii) Services in an institution for mental  
440.150, 440.160, 1902(a)(10)(c) diseases for individuals over age 65.

Subpart B,

442.441,

Subpart C

1902(a)(20)

and (21) of the Act

x (viii) Services in an intermediate care facility for the mentally retarded.

1902(a)(10)(D)

x (ix) Inpatient psychiatric services for individuals under age 21.

---

TN No. 92-01

Supersedes

TN No. 87-5

Approval Date 10-21-92

Effective Date 1/1/92

HCFA ID: 7982E

Revision: HCFA-PM-93-5 (MB)  
MAY 1993

State: North Carolina

Citation

	3.1(a)(2)	<u>Amount, Duration, and Scope of Services: Medically Needy</u> (Continued)
1902(e)(9) of Act	___ (x)	Respiratory care services are provided to ventilator dependent individuals as indicated in Item 3.1(h) of this plan.
1905(a)(23) and 1929 of the Act	___ (xi)	Home and Community Care for Functionally Disabled Elderly Individuals, as defined, described and limited in Supplement 2 to Attachment 3.1-A and Appendices A-G to Supplement 2 to Attachment 3.1-A.
1905(a)(26) and 1934 of the Act	<u>X</u> (xii)	Program of All-Inclusive Care for the Elderly (PACE)

ATTACHMENT 3.1-A identifies the medical and remedial services provided to the categorically needy. (Note: Other programs to be offered to Categorically Needy beneficiaries would specify all limitations on the amount, duration and scope of those services. As PACE provides services to the frail elderly population without such limitation, this is not applicable for this program. In addition, other programs to be offered to Categorically Needy beneficiaries would also list the additional coverage -that is in excess of established service limits- for pregnancy-related services for conditions that may complicate the pregnancy. As PACE is for the frail elderly population, this also is not applicable for this program.)

---

TN No.: 06-009  
Supersedes  
TN No.: 93-17

---

Approval Date: 12/04/06  
Effective Date: 01/01/07

Revision: HCFA-PM-97-3 (CMSO)  
December 1997

State: North Carolina

Citation 3.1 Amount, Duration, and Scope of Services  
(continued)

(a)(3) Other Required Special Groups:  
Qualified Medicare Beneficiaries

1902(a)(10)(E)(i) Medicare cost sharing for qualified  
and clause (VIII) Medicare beneficiaries described in  
of the matter section 1905 (p) of the Act is  
following (F), provided only as indicated in item 3.2  
and 1905(p)(3) of this plan  
of the Act

1902(a)(10) (a)(4)(i) Other Required Special Groups:  
(E)(ii) and Qualified Disabled and Working  
1905(s) of the Individuals  
Act

Medicare Part A premiums for qualified  
disabled and working individuals described in  
section 1902(a)(10)(E) (ii) of the Act are provided  
as indicated in item 3.2 of this plan

1902(a)(10) (ii) Other Required Special Groups:  
(E)(iii) and specified Low-income Medicare  
1905(p)(3)(A)(ii) Beneficiaries  
of the Act

Medicare Part B premiums for specified  
low-income Medicare beneficiaries described in  
section 1902 (a)(10)(E) (iii) of the Act are  
provided as indicated in item 3.2 of this plan.

1902(a)(10) (iii) Other Required Special Groups:  
(E)(iv)(I)1905(p)(3) Qualifying Individuals - 1  
(A)(ii), and 1933 of  
the Act

Medicare Part B premiums for  
qualifying individuals described in  
1902(a)(10)(E)(iv)(I)and subject to 1933 of the Act  
are provided as indicated in item 3.2 of this plan

---

TN No. 98-04  
Supersedes  
TN No. 93-03

Approval Date 5/27/98

Effective Date 1-1-98



Revision: HCFA-PM-97-3 (CMSO)  
December 1997

State: North Carolina

---

1902(a)(10)  
(E)(iv)(II), 1905(p)(3)  
(A)(iv)(II), 1905(p)(3)  
the Act

(iv) Other Required Special Groups:  
Qualifying Individuals - 2

The portion of the amount of increase to the Medicare Part B premium attributable to the Home Health provisions for qualifying Individuals described in 1902(A)(10)(E)(iv) (II) and subject to 1933 of the Act are provided as indicated in item 3.2 of this plan.

1925 of the  
Act

(a)(5) Other Required Special Groups:  
Families Receiving Extended  
Medicaid Benefits

Extended Medicaid benefits for families described in section 1925 of the Act are provided as indicated in item 3.5 of this plan.

---

TN No. 98-04  
Supersedes  
TN No. 92-01

Approval Date 5/27/98

Effective Date 1-1-98

Revision: HCFA-PM-91-4 (BPD)  
August 1991

OMB No.: 0938

State: North Carolina

Citation            3.1    Amount, Duration, and Scope of Services  
(continued)

- 1902(a) and 1903 (v) of the Act and Section 401(b)(1)(A) of P.L. 104-193    (a)(6) Limited Coverage for Certain Aliens  
Is an alien who is not a qualified alien or who is a qualified alien, as defined in section 431 (b) of P.L. 104-193, but is not eligible for Medicaid based on alienage status, and who would otherwise qualify for Medicaid are provided Medicaid only for the treatment of an emergency medical condition (including emergency labor and delivery) as defined in section 1903 (v)(3) of the Act.
- 1905(a)(9) of the Act                            (a)(7) Homeless Individuals  
Clinic services furnished to eligible individuals who do not reside in a permanent dwelling or do not have a fixed home or mailing address are provided without restrictions regarding the site at which the services are furnished.
- 1902(a)(47) and 1920 of the Act                            x    (a)(8) Presumptively Eligible Pregnant Women  
Ambulatory prenatal care for pregnant women is provided during a presumptive eligibility period if the care is furnished by a provider that is eligible for payment under the State Plan.
- 42 CFR 441.55 50 FR 43654 1902(a)(43), 1905(a)(4)(B), and 1905(r) of the Act    (a)(9) EPSDT Services  
The Medicaid agency meets the requirements of sections 1902(a)(43), 1905(a)(4)(B), and 1905(r) of the Act with respect to early and periodic screening, diagnostic, and treatment (EPSDT) services.

TN No. 98-04  
Supersedes  
TN No. 92-01

Approval Date 5/27/98

Effective Date 1-1-98  
HCFA ID: 7982E

Revision: HCFA-PM-91- 4  
AUGUST 1991

(BPD)

OMB No. 0938-

State/Territory: North Carolina

Citation 3.1(a)(9) Amount, Duration, and Scope of Services:  
EPSDT Services (continued)

- 42 CFR 441.60                    \_\_\_    The Medicaid agency has in effect agreements with continuing care providers. Described below are the methods employed to assure the providers' compliance with their agreements.
- 42 CFR 440.240               (a)(10)   Comparability of Services  
and 440.250
- 1902(a) and 1902  
(a)(10), 1902 (a)(52)  
1903(v), 1915(g),  
1925 (b)(4), and 1932  
of the Act
- Except for those items or services for which sections 1902(a), 1902(a)(10), 1903(v) 1915, 1925, and 1932 of the Act, 42 CFR 440.250, and section 245A of the Immigration and Nationality Act, permit exceptions:
- (i) Services made available to the categorically needy are equal in amount, duration, and scope for each categorically needy person.
  - (ii) The amount, duration, and scope of services made available to the categorically needy are equal to or greater than those made available to the medically needy.
  - (iii) Services made available to the medically needy are equal in amount, duration, and scope for each person in a medically needy coverage group.
  - X (iv) Additional coverage for pregnancy-related services and services for conditions that may complicate the pregnancy are equal for categorically and medically needy.

The continuing care provider submits monthly encounter data reflecting the number of examinations completed, the number of examinations where a referable condition was identified, and the number of follow-up treatment encounters. Medicaid staff make periodic on-site reviews to monitor the provider's record of case management.

---

TN No. 03-04

Supersedes  
TN No. 92-01

Approval Date: **NOV 18 2003**

Effective Date 8/13/2003  
HCFA ID: 7982E

Revision: HCFA-AT-80-38 (BPP)  
May 22, 1980

State North Carolina

Citation 3.1(b) Home health services are provided in accordance with the requirements of 42 CFR 441.15.

42 CFR Part 440, Subpart B  
42 CM 441.15  
AT-78-90  
AT-80-34

(1) Home health services are provided to all categorically needy individuals 21 years of age or over.

(2) Home health services are provided to all categorically needy individuals under 21 years of age.

Yes

Not applicable. The State plan does not provide for skilled nursing facility services for such individuals.

(3) Home health services are provided to the medically needy:

Yes, to all

Yes, to individuals age 21 or over; SNF services are provided

Yes, to individuals under age 21; SNF services are provided

No; SNF services are not provided

Not applicable; the medically needy are not included under this plan

TN # 80-02  
Supersedes  
TN # \_\_\_\_\_

Approval Date 3/12/80

Effective Date 1/1/80

Revision: HCFA-PM-93-8 (BPD)  
December 1993

State/Territory: North Carolina

Citation 3.1 Amount, Duration, and Scope of Services (continued)

42 CFR 431.53 (c)(1) Assurance of Transportation

Provision is made for assuring necessary Transportation of recipients to and from providers. Methods used to assure such transportation are described in ATTACHMENT 3.1-D.

42 CFR 483.10 (c)(2) Payment for Nursing Facility Services

The State includes in nursing facility services at least the items and services specified in 42 CFR 483.10 (c)(8)(i).

42 CFR 447.40 (c)(3) Therapeutic Leave

Payment is made to reserve a bed during a recipient's temporary absence from an inpatient facility.

Yes. The State's policy is described in ATTACHMENT 3.1-A.1

No.

TN No. 01-27  
Supersedes  
TN No. 94-03

Approval Date: MAR 22 2002

Effective Date 10/01/01

Revision: HCFA-AT-80-38(BPP)  
May 22, 1980

State North Carolina

Citation                      3.1(d)                      Methods and Standards to Assure  
42 CFR 440.260                      Quality of Services  
AT-78-90

The standards established and the methods used to assure high quality care are described in ATTACHMENT 3.1-C.

TN # 77-11  
Supersedes  
TN # \_\_\_\_\_

Approval Date 10/21/77                      Effective Date 7/1/77

Revision: HCFA-AT-80-38 (BPP)  
May 22, 1980

State North Carolina

---

Citation            3.1(e) Family Planning Services

42 CFR 441.20  
AT-78-90

The requirements of 42 CFR 441.20 are met regarding freedom from coercion or pressure of mind and conscience, and freedom of choice of method to be used for family planning.

---

TN # 77-11  
Supersedes  
TN # \_\_\_\_\_

Approval Date 10/21/77

Effective Date 7/1/77

Revision: HCFA-PM-87-5 (BERC)  
APRIL 1987

OMB No.: 0938-0193

State/Territory: North Carolina

Citation                    3.1 (f)(1)            Optometric Services  
42 CFR 441.30                    Optometric services (other than those  
AT-78-90                                    provided under 435.531 and 436.531)  
are not now but were previously provided under the  
plan. Services of the type an optometrist is legally  
authorized to perform are specifically included in  
the term "physicians' services" under this plan and  
are reimbursed whether furnished by a physician or  
an optometrist.

Yes.

No. The conditions described in  
the first sentence apply but the term  
"physicians' services" does not specifically  
include services of the type an optometrist  
is legally authorized to perform.

Not applicable. The conditions  
in the first sentence do not  
apply.

1903(i)(1)                                    (2)            Organ Transplant Procedures  
of the Act,                                    Organ transplant procedures are  
P.L. 99-272                                    provided  
(Section 9507)

No.

Yes. Similarly situated  
individuals are treated alike and any  
restriction on the facilities that may, or  
practitioners who may, provide those  
procedures is consistent with the  
accessibility of high quality care to  
individuals eligible for the procedures under  
this plan. Standards for the coverage of  
organ transplant procedures are described at  
ATTACHMENT 3.1-E.

TN No. 87-5

Supersedes

Approval Date JUL 23 1987

Effective Date 4-1-87

TN No. 77-11

HCFA ID: 1008P/0011P



Revision: HCFA-PH-87-4 (BERC)  
MARCH 1987

OMB No. 0938-0193

State/Territory: North Carolina

<p>Citation 42CFR 431.110(b) AT-78-90</p>	<p>3.1 (g)</p>	<p><u>Participation by Indian Health Service Facilities</u></p> <p>Indian Health Service facilities are accepted as providers, in accordance with 42 CFR 431. 110(b), on the same basis as other qualified providers</p>
<p>1902(e)(9)of the Act, P.L. 99-509 (Section 9408)</p>	<p>(h)</p>	<p><u>Respiratory Care Services for Ventilator- Dependent Individuals</u></p> <p>Respiratory care services, as defined in section 1902(e)(9)(C) of the Act, are provided under the plan to individuals who--</p> <p>(1) Are medically dependent on a ventilator for life support at least six hours per day;</p> <p>(2) Have been so dependent as inpatients during a single stay or a continuous stay in one or more hospitals, SNFs or ICFs for the lesser of--</p> <p style="padding-left: 40px;"><u>      </u> 30 consecutive days;</p> <p style="padding-left: 40px;"><u>      </u> <u>      </u> days (the maximum number of inpatient days allowed under the State plan);</p> <p>(3) Except for home respiratory care, would require respiratory care on an inpatient basis in a hospital, SNF, or ICF for which Medicaid payments would be made;</p> <p>(4) Have adequate social support services to be cared for at home; and</p> <p>(5) Wish to be cared for at home.</p> <p><u>      </u> Yes. The requirements of section 1902(e)(9) of the Act are met.</p> <p><u>  X  </u> Not applicable. These services are not included in the plan.</p>

TN No. 87-5  
Supersedes  
TN No. 78-3

Approval Date JUL 23 1987

Effective Date 4/1/87  
HCFA ID: 1008P/0011P

Revision: HCFA-PM-93-5 (MB)  
MAY 1993

State: North Carolina

Citation                    3.2 Coordination of Medicaid with Medicare and Other Insurance

(a) Premiums

(1) Medicare Part A and Part B

1902(a)(10)(E)(i) and  
1905(p)(1) of the Act

(i) Qualified Medicare Beneficiary (QMB)

The Medicaid agency pays Medicare Part A premiums (if applicable) and Part B premiums for individuals in the QMB group defined in Item A.25 of ATTACHMENT 2.2-A, through the group premium payment arrangement, unless the agency has a Buy-in agreement for such payment, as indicated below.

Buy-In agreement for:

  X   Part A              X   Part B

       The Medicaid agency pays premiums, for which the beneficiary would be liable, for enrollment in an HMO participating in Medicare.

---

TN No. 93-17  
Supersedes  
TN No. 93-03

Approval Date 11-15-93

Effective Date 7/1/93

Revision: HCFA-PM-97-3 (CSMO)  
December 1997

State: North Carolina

---

Citation

1902(a)(10)(E)(ii)  
and 1905(s) of the Act

(ii) Qualified Disabled and Working  
Individual (QDWI)

The Medicaid agency pays Medicare Part A premiums under a group premium payment arrangement, subject to any contribution required as described in ATTACHMENT 4.18-E, for Individuals in the QDWI group defined in item A.26 of ATTACHMENT 2.2-A of this plan.

1902(a)(10)(E)(iii)  
and 1905(p)(3)(A)(ii)  
of the Act

(iii) Specified Low-income Medicare  
Beneficiary (SLMB)

The Medicaid agency pays Medicare Part B premiums under the State buy-In process for individuals in the SLMB group defined in item A.27 of ATTACHMENT 2.2-A of this plan.

1902(a)(10)(E)(iv)(I),  
1905(p)(3)(A)(ii), and  
1933 of the Act

(iv) Qualifying Individual-1) (QI-1)

The Medicaid agency pays Medicare Part B premiums under the State buy-in process for individuals described in 1902 (a) (10) (E) (iv) (I) and subject to 1933 of the Act.

1902(a)(10)(E)(iv)(II),  
1905(p)(3)(A)(ii), and  
1933 of the Act

(v) Qualifying Individual-2(QI-2)

The Medicaid agency pays the portion of the amount of increase to the Medicare Part B premium attributable to the Home Health Provision to the individuals described in 1902 (a) (10) (E) (iv) (II) and subject to 1933 of the Act.

---

TN No. 98-04

Supersedes

Approval Date 5/27/98

Effective Date 1-1-98

TN No. 93-03

Revision: HCFA-PM-97-3  
December 1997

State: North Carolina

---

Citation

1843(b) and 1905(a)  
of the Act and  
42 CFR 431.625

(vi) Other Medicaid Recipients

The Medicaid agency pays  
Medicare Part B premiums to make Medicare Part B  
coverage available to the Following individuals:

X All individuals who are: (a)  
receiving benefits under titles I, IV-A,  
X, XIV, XVI (AABD or SSI); b) receiving  
State supplements under title XVI; or c)  
within a group listed at 42 CFR 431. 625  
(d)(2).

— Individuals receiving title  
II or Railroad Retirement benefits.

X Medically needy individuals  
(FFP is not available for this group).

1902(a)(30) and  
1905(a) of the Act

(2) Other Health Insurance

— The Medicaid agency pays insurance  
premiums for medical or any other type of remedial  
care to maintain a third party resource for  
Medicaid covered services provided to eligible  
individuals (except individuals 65 years of age or  
older and disabled individuals, entitled to  
Medicare Part A but not enrolled in Medicare Part  
B).

---

TN No. 98-04  
Supersedes  
TN No. 93-03

Approval Date 5/27/98

Effective Date 1-1-98

Revision: HCFA-PM-93-2 (MB)  
MARCH 1993

State: North Carolina

Citation (b) Deductibles/Coinsurance

(1) Medicare Part A and B

1902(a)(30), 1902(n),  
1905(a), and 1916 of the Act

**ATTACHMENT 4.19-B, Section 24, Page 1**  
describe the methods and standards for  
establishing payment rates for services  
covered under Medicare, and/or the  
methodology for payment of Medicare  
deductible and coinsurance amounts, to the  
extent available for each of the following  
groups.

Sections 1902  
(a)(10)(E)(i) and  
1905(p)(3) of the Act

(i) Qualified Medicare Beneficiaries  
QMBs

The Medicaid agency pays Medicare Part A and Part B  
deductible and coinsurance amounts for QMBs (subject to any  
nominal Medicaid (copayment) for all services available under  
Medicare.

1902(a)(10), 1902(a)(30),  
and 1905(a) of the Act

(ii) Other Medicaid Recipients

The Medicaid agency pays for Medicaid services also covered  
under Medicare and furnished to recipients entitled to  
Medicare (subject to any nominal Medicaid copayment). For  
services furnished to individuals who are described in  
section 3.2(a)(1) (iv), payment is made as follows:

42 CFR 431.625

X For the entire range of services  
available under Medicare Part 3.

\_\_\_ Only for the amount, duration, and  
scope of services otherwise  
available under this plan.

1902(a)(10), 1902(a)(30),  
1905(a), and 1905(p)  
of the Act

(iii) Dual Eligible--QMS Plus

The Medicaid agency pays Medicare  
Part A and Part B deductible and coinsurance amounts for all  
services available under Medicare and pays for all Medicaid  
services furnished to individuals eligible both as QMBs and  
categorically or medically needy (subject to any nominal  
Medicaid copayment).

TN No. 03-05  
Supersedes  
TN No. 93-03

Approval Date 5/23/03

Effective Date 04/01/03

Revision: HCFA-PM-91-8 (MB)  
October 1991

OMB No.:

State/Territory: North Carolina

Citation

Condition or Requirement

1906 of the  
Act

(c) Premiums, Deductibles, Coinsurance  
and Other Cost Sharing Obligations

The Medicaid agency pays all premiums, deductibles, coinsurance and other cost sharing obligations for items and services covered under the State plan (subject to any nominal Medicaid copayment) for eligible individuals in employer-based cost-effective group health plans.

When coverage for eligible family members is not possible unless ineligible family members enroll, the Medicaid agency pays premiums for enrollment of other family members when cost-effective. In addition, the eligible individual is entitled to services covered by the State plan which are not included in the group health plan. Guidelines for determining cost effectiveness are described in section 4.22(h).

1902(a)(10)(F)  
of the Act

(d) \_\_\_\_\_ The Medicaid agency pays premiums for individuals described in item 19 of Attachment 2.2-A.

TN No. 92-27  
Supercedes  
TN No. NEW

Approval Date 1-31-94

Effective Date 7/1/92  
HCFA ID: 7983E

Revision: HCFA-AT-80-38 (BPP)  
May 22, 1980

State North Carolina

---

Citation  
42 CFR 441.101,  
42 CFR 431.620(c)  
and (d)  
AT-79-29

3.3 Medicaid for Individuals Age 65 or  
Over in Institutions for Mental Diseases

Medicaid is provided for individuals 65  
years of age or older who are patients  
in institutions for mental diseases.

X Yes. The requirements of 42 CFR  
Part 441, Subpart C, and 42 CFR 431.620(c) and (d)  
are met.

— Not applicable. Medicaid is not  
provided to aged individuals in such institutions  
under this plan.

---

TN # 77-11  
Supersedes  
TN # \_\_\_\_\_

Approval Date 10/21/77 Effective Date 7/1/77

Revision: HCFA-AT-80-38 (BPP)  
May 22, 1980

State North Carolina

Citation                    3.4    Special Requirements Applicable to  
42 CFR 441.252                    Sterilization Procedures  
AT-78-99

All requirements of 42 CFR Part 441, Subpart F are met.

---

TN # 79-3  
Supersedes                    Approval Date 5/4/79                    Effective Date 3/31/79  
TN # \_\_\_\_\_



Revision: HCFA-PM-91-4 (BPD)  
AUGUST 1991

OMB No.: 0938-

State: North Carolina

Citation

1902(a)(52)  
and 1925 of  
the Act

3.5 Families Receiving Extended Medicaid Benefits

- (a) Services provided to families during the first 6-month period of extended Medicaid benefits under Section 1925 of the Act are equal in amount, duration, and scope to services provided to categorically needy AFDC recipients as described in ATTACHMENT 3.1-A (or may be greater if provided through a caretaker relative employer's health insurance plan).
- (b) Services provided to families during the second 6-month period of extended Medicaid benefits under section 1925 of the Act are--

- x Equal in amount, duration, and scope to services provided to categorically needy recipients as described in ATTACHMENT 3.1-A (or may be greater if provided through a caretaker relative employer's health insurance plan).
- \_\_\_ Equal in amount, duration, and scope to services provided to categorically needy AFDC recipients, (or may be greater if provided through a caretaker relative employer's health insurance plan) minus any one or more of the following acute services:
- \_\_\_ Nursing facility services (other than services in an institution for mental diseases) for individuals 21 years of age or older.
- \_\_\_ Medical or remedial care provided by licensed practitioners.
- \_\_\_ Home health services.

TN No. 92-01  
Supersedes  
TN No. 91-42

Approval Date 10-21-92 Effective Date 1/1/92  
HCFA ID: 7982E

Revision: HCFA-PM-91-4 (BPD)  
AUGUST 1991

OMB No.: 0938-

State: North Carolina

Citation      3.5      Families Receiving Extended Medicaid Benefits(Continued)

\_\_\_      Private duty nursing services.

\_\_\_      Physical therapy and related services.

\_\_\_      Other diagnostic, screening, preventive, and rehabilitation services.

\_\_\_      Inpatient hospital services and nursing facility services for individuals 65 years of age or over in an institution for mental diseases.

\_\_\_      Intermediate care facility services for the mentally retarded.

\_\_\_      Inpatient psychiatric services for individuals under age 21.

\_\_\_      Hospice services.

\_\_\_      Respiratory care services.

\_\_\_      Any other medical care and any other type of remedial care recognized under State law and specified by the Secretary.

TN No. 92-01  
Supersedes  
TN No. 87-18

Approval Date 10-21-92

Effective Date 1/1/92  
HCFA ID: 7982E

Revision: HCFA-PM-91-4 (BPD)  
AUGUST 1991

OMB No. 0938

State: North Carolina

Citation 3.5 Families Receiving Extended Medicaid Benefits  
(Continued)

(C)\_\_\_ The agency pays the family's premiums, enrollment fees, deductibles, coinsurance, and similar costs for health plans offered by the caretaker's employer as payments for medical assistance--

\_\_\_ 1st 6 months \_\_\_ 2nd 6 months

\_\_\_ The agency requires caretakers to enroll in employers' health plans as a condition of eligibility.

\_\_\_ 1st 6 mos. \_\_\_ 2nd 6 mos.

(d)\_\_\_ (1)The Medicaid agency provides assistance to families during the second 6-month period of extended Medicaid benefits through the following alternative methods:

\_\_\_ Enrollment in the family option of an employer's health plan.

\_\_\_ Enrollment in the family option of a State employee health plan.

\_\_\_ Enrollment in the State health plan for the uninsured.

\_\_\_ Enrollment in an eligible health maintenance organization (HMO) with a prepaid enrollment of less than 50 percent Medicaid recipients (except recipients of extended Medicaid).

---

TN No. 92-01

Supersedes \_\_\_\_\_ Approval Date 10-21-92 Effective Date 1/1/92

TN No. 90-9

HCFA ID: 7982E

Revision: HCFA-PM-91-4 (BPD)  
AUGUST 1991

OMB No. 0938-

State: North Carolina

Citation            3.5 Families Receiving Extended Medicaid Benefits(Continued)

Supplement 2 to ATTACHMENT 3.1-A specifies and describes the alternative health care plan(s) offered, including requirements for assuring that recipients have access to services of adequate quality.

(2) The agency--

(i) Pays all premiums and enrollment fees imposed on the family for such plan(s).

— (ii) Pays all deductibles and coinsurance imposed on the family for such plan(s).

TN No. 92-01  
Supersedes  
TN No. 90-09

Approval Date 10-21-92

Effective Date 1/1/92  
HCFA ID: 7982E

\_\_\_\_ Enrollment in an eligible health maintenance organization (HMO) that has an enrollment of less than 50 percent of Medicaid recipients who are not recipients of extended Medicaid.

Supplement 2 to ATTACHMENT 3.1-A specifies and describes the alternative health care plan(s) offered, including requirements for assuring that recipients have access to services of adequate quality.

(2) The agency--

(i) Pays all premiums and enrollment fees imposed on the family for such plan(s).

\_\_\_\_ (ii) Pays all deductibles and coinsurance imposed on the family for such plan(s).

---

TN No. 90-09  
Supercedes  
TN No. New

Approval Date JUN 22 1990

Effective Date 4/1/90

State: North Carolina

3.6 Unemployed Parent

For purposes of determining whether a child is deprived on the basis of the unemployment of a parent, the agency

\_\_\_ Uses the standard for measuring unemployment which was in the AFDC State plan in effect on July 16, 1996.

\_\_\_ Uses the following more liberal standard to measure unemployment:

The parent will be considered unemployed if the family meets the financial requirements listed under 42 CFR 435, Subparts G and 1.

Revision: HCFA-PM-87-4 (BERC)  
MARCH 1987

OMB No.: 0938-0193

State/Territory: North Carolina

SECTION 4 - GENERAL PROGRAM ADMINISTRATION

Citation  
42 CFR 431.15  
AT-79-29

4.1 Methods of Administration

The Medicaid agency employs methods of administration found by the Secretary of Health and Human Services to be necessary for the proper and efficient operation of the plan.

---

TN No. 87-5

Supersedes

TN No. 74-21

Approval Date JUL 23 1987

Effective Date 4/1/87

HCFA ID: 1010P/0012P

Revision: HCFA-AT-80-38 (BPP)  
May 22, 1980

State North Carolina

Citation  
42 CFR 431.202  
AT-79-29  
AT-80-34

4.2 Hearings for Applicants and Recipients

The Medicaid agency has a system of hearings that meets all the requirements of 42 CFR Part 431, Subpart E.

---

TN # 74-21  
Supersedes  
TN # \_\_\_\_\_

Approval Date 8/19/74

Effective Date 4/8/74



Revision: HCFA-AT-87-9  
AUGUST 1987

(BERC)

OMB No.: 0938-0193

State/Territory: North Carolina

Citation  
42 CFR 431.301  
AT-79-29

4.3

Safeguarding Information on Applicants  
and Recipients

Under State statute which imposes legal sanctions, safeguards are provided that restrict the use or disclosure of information concerning applicants and recipients to purposes directly connected with the administration of the plan.

52 FR 5967

All other requirements of 42 CFR Part 431, Subpart F are met.

---

TN No. 87-12  
Supersedes  
TN No. 74-21

Approval Date 1/28/88

Effective Date 10-1-87  
HCFA ID: 1010P/0012P

Revision:

State/Territory: North Carolina

Citation

42 CFR 431 Subparts P & Q  
 50 FR 21839  
 75 FR 48847  
 1903(u) of  
 the Act,  
 P.L. 99-509  
 (Section 9407)  
 P.L. 107-300  
 P.L. 111-3

4.4 Medicaid Eligibility Quality Control (MEQC)

(a) A system of quality control is implemented in accordance with 42 CFR Part 431, Subpart P.

Yes

Not Applicable. The State operates an Approved MEQC Pilot

(b) In accordance with 431.806(c), the State operates a Medicaid quality control claims processing assessment system that meets the requirements of 431.830 – 431.836.

Yes.

Not applicable. The State has an approved Medicaid Management Information System (MMIS).

(c) In accordance with 431.806(b), Payment Error Rate Measurement (PERM) is implemented in accordance with 42 CFR Part 431, Subpart Q, in substitution to meet the statutory and regulatory (“traditional”) Medicaid Eligibility Quality Control (MEQC) review during the State’s PERM cycle year.

Yes.

Effective for FFY 2013

Effective for FFY 2016

Effective for FFY 2019

Not applicable.

---

TN No. 12-017

Supersedes

TN No. 88-3

Approval Date: 11-21-12

Effective Date 10/01/2012

Revision: HCFA-PM-88-10 (BERC)  
SEPTEMBER 1988

OMB No.: 0938-0193

State/Territory: North Carolina

Citation  
42 CFR 455.12  
AT-78-90  
48 FR 3742  
52 FR 48817

4.5 Medicaid Agency Fraud Detection and Investigation Program

The Medicaid agency has established and will maintain methods, criteria, and procedures that meet all requirements of 42 CFR 455.13 through 455.21 and 455.23 for prevention and control of program fraud and abuse.

---

TN No. 88-18  
Supersedes  
TN No. 83-08

Approval Date JAN 09 1989  
Received 1-3-89

Effective Date 10/1/88  
HCFA ID: 1010P/0012P

New: HCFA-PM-99-3 (CMSO)  
JUNE 1999

State: \_\_\_\_\_

Citation 4.5a Medicaid Agency Fraud Detection  
Section 1902(a)(64) And Investigation Program  
The Social Security Act  
P.L. 105-33

The Medicaid agency has established a mechanism to receive reports from beneficiaries and others and compile data concerning alleged instances of waste, fraud, and abuse relating to the operation of this title.

TN No. 99-23  
Supersedes  
TN No. NEW

Approval Date: DEC 20 1999 Eff. Date: 8/5/97

Revision: HCFA-AT-80-38(BPP)  
 May 22, 1980  
 State North Carolina

---

Citation  
 42 CFR 431.16  
 AT-79-29

4.6 Reports

The Medicaid agency will submit all reports in the form and with the content required by the Secretary, and will comply with any provisions that the Secretary finds necessary to verify and assure the correctness of the reports. All requirements of 42 CFR 431.16 are met.

TN # 77-20  
 Supersedes  
 TN # \_\_\_\_\_

Approval Date 1/24/78

Effective Date 10/1/77

Revision: HCFA-AT-80-38 (BPP)  
 May 22, 1980

State North Carolina

---

Citation  
 42 CFR 431.17  
 AT-79-29

4.7 Maintenance of Records

The Medicaid agency maintains or supervises the maintenance of records necessary for the proper and efficient operation of the plan, including records regarding applications, determination of eligibility, the provision of medical assistance, and statistical, fiscal and other records necessary for reporting and accountability, and retains these records in accordance with Federal requirements. All requirements of 42 CFR 431.17 are met.

---

TN # 77-20  
 Supersedes  
 TN # \_\_\_\_\_

Approval Date 1/24/78

Effective Date 10/1/77

Revision: HCFA-AT-80-38 (BPP)  
 May 22, 1980

State North Carolina

---

<u>Citation</u> 42 CFR 431.18(b) AT-79-29	4.8 <u>Availability of Agency Program Manuals</u>	Program manuals and other policy issuances that affect the public, including the Medicaid agency's rules and regulations governing eligibility, need and amount of assistance, recipient rights and responsibilities, and services offered by the agency are maintained in the State office and in each local and district office for examination, upon request, by individuals for review, study, or reproduction. All requirements of 42 CFR, 431.18 are met.
---	---	--

---

TN # 74-12  
 Supersedes  
 TN # \_\_\_\_\_

Approval Date 8/19/74

Effective Date 3/18/74

Revision: HCFA-AT-80-38 (BPP)  
May 22, 1980

State North Carolina

Citation  
42 CFR 433.37  
AT-78-90

4.9 Reporting Provider Payments to Internal Revenue Service

There are procedures implemented in accordance with 42 CFR 433.37 for identification of providers of services by social security number or by employer identification number and for reporting the information required by the Internal Revenue Code (26 U.S.C. 6041) with respect to payment for services under the plan.

---

TN #74-13  
Supersedes Approval Date 8/19/74 Effective Date 3/18/74  
TN #\_\_\_\_\_



Revision: HCFA-PNI-99-3  
JUNE 1999

(CMSO)

State: North Carolina

- Citation 4.10 Free Choice of Providers  
42 CFR 431.51  
AT-78-90  
46 FR 48524  
48 FR23212  
1902 (a) 23  
of the Act  
P.L. 100-93  
(section 8 (f))
- (a) Except as provided in paragraph (b), the Medicaid agency assures that an individual eligible under the plan may obtain Medicaid services from any institution, agency, pharmacy, person, or organization that is qualified to perform the services, including an organization that provides these services or arranges for their availability on a prepayment basis.
- P.L. 100-203 (Section 4113)
- (b) Paragraph (a) does not apply to services furnished to an individual--
- (1) Under an exception allowed under 42 CFR 431.54, subject to the limitations in paragraph (c), or
  - (2) Under a waiver approved under 42 CFR 431.55, subject to the limitations in paragraph (c), or
  - (3) By an individual or entity excluded from participation in accordance with section 1902(p) of the Act,
  - (4) By individuals or entities who have been convicted of a felony under Federal or State law and for which the State determines that the offense is inconsistent with the best interests of the individual eligible to obtain Medicaid services.
  - (5) Under an exception allowed under 42 CFR 438.50 or 42 CFR 440.168, subject to the limitations in paragraph (c).
- Section 1902(a)(23)  
of the Social Security Act  
P.L. 105-33
- Section 1932(a)(1)  
Section 1905(t)
- (c) Enrollment of an individual eligible for medical assistance in a primary care case management system described in Section 1905 (t), 1915(a) 1915(b)(1), or 1932 (a); or managed care organization, prepaid inpatient health plan, a prepaid ambulatory health plan, or a similar entity shall not restrict the choice of the qualified person from whom the individual may receive emergency services or services under section 1905(a)(4)(c).

TN No. 03-04  
Supersedes  
TN No. 99-24

Approval Date: NOV 18 2003 Effective Date 8/13/2003

Revision: HCFA-AT-80-38 (BPP)

May 22, 1980

State North Carolina

Citation  
 42 CFR 431.610  
 AT-78-90  
 AT-80-34

4.11 Relations with Standard-Setting and  
 Survey Agencies

(a) The State agency utilized by the Secretary to determine qualifications of institutions and suppliers of services to participate in Medicare irresponsible for establishing and maintaining health standards for private or public institutions (exclusive of Christian Science sanatoria) that provide services to Medicaid recipients. This agency is the Department of Health

and Human Services

(b) The State authority(ies) responsible for establishing and maintaining standards, other than those relating to health, for public or private institutions that provide services to Medicaid recipients is (are) : the Department of Health and

Human Services

(c) ATTACHMENT 4.11-A describes the standards specified in paragraphs (a) and (b) above, that are kept on file and made available to the Health Care Financing Administration on request.

TN # 00-03  
 Supersedes  
TN# 74-13

Approval Date Aug 02 2000

Effective Date 04/01/00

Revision: HCFA-AT-80-38 (BPP)  
May 22, 1980

State North Carolina

Citation  
42 CFR 431.610  
AT-78-90

4.11(d)

The Department of Health and  
Human Services (agency)

AT-89-34

which is the State agency responsible for licensing health institutions, determines if institutions and agencies meet the requirements for participation in the Medicaid program. The requirements in 42 CFR 431.610(e),(f) and (g) are met.

---

TN # 00-03  
Supersedes  
TN # 74-13

Approval Date Aug 02 2000

Effective Date 04/01/00

Revision: HCFA-AT-80-38 (BPP)

May 22, 1980

State North Carolina

Citation  
42 CFR 431.105 (b)  
AT-78-90

4.12 Consultation to Medical Facilities

- (a) Consultative services are provided by health and other appropriate State agencies to hospitals, nursing facilities, home health agencies, clinics and laboratories in accordance with 42 CFR 431.105(b).
- (b) Similar services are provided to other types of facilities providing medical care to individuals receiving services under the programs specified in 42 CFR 431.105(b).

Yes, as listed below:

Not applicable. Similar services are not provided to other types of medical facilities.

TN # 73-45  
Supersedes  
TN # \_\_\_\_\_

Approval Date 7/19/74

Effective Date 10/1/73

Revision: HCFA-PM-91-4 (BPD)  
AUGUST 1991

OMB No.: 0938--

State/Territory: North Carolina

Citation 4.13 Required Provider Agreement

With respect to agreements between the Medicaid agency and each provider furnishing services under the plan:

- 42 CFR 431.107 (a) For all providers, the requirements of 42 CFR 431.107 and 42 CFR Part 442, Subparts A and B (if applicable) are met.
- 42 CFR Part 483, 1919 of the Act (b) For providers of NF services, the requirements of 42 CFR Part 483, Subpart B, and section 1919 of the Act are also met.
- 42 CFR Part 483, Subpart D (c) For providers of ICF/MR services, the requirements of participation in 42 CFR Part 483, Subpart D are also met.
- 1920 of the Act (d) For each provider that is eligible under the plan to furnish ambulatory prenatal care to pregnant women during a presumptive eligibility period, all the requirements of section 1920(b)(2) and (c) are met.

\_\_\_\_ Not applicable. Ambulatory prenatal care is not provided to pregnant women during a presumptive eligibility period.

Supersede  
TN No. 88-3

Approval Date 10-21-92

Effective Date 1/1/92

HCFA ID: 7982E

45(a)

Revision: HCFA-PM-91-9  
October 1991

(MB)

OMB No.:

State/Territory: North Carolina

Citation

1902(a)(58)  
1902(w)

- 4.13 (e) For each provider receiving funds under the plan, all the requirements for advance directives of section 1902(w) are met:
- (1) Hospitals, nursing facilities, providers of home health care or personal care services, hospice programs, managed care organizations, prepaid inpatient health plans, prepaid ambulatory health plans (unless the PAHP excludes providers in 42 CFR 489.102) and health insuring organizations are required to do the following:
- (a) Maintain written policies and procedures with respect to all adult individuals receiving medical care by or through the provider or organization about their rights under State law to make decisions concerning medical care, including the right to accept or refuse medical or surgical treatment and the right to formulate advance directives.
- (b) Provide written information to all adult individuals on their policies concerning implementation of such rights;
- (c) Document in the individual's medical records whether or not the individual has executed an advance directive;
- (d) Not condition the provision of care or otherwise discriminate against an individual based on whether or not the individual has executed an advance directive;
- (e) Ensure compliance with requirements of State Law (whether

---

TN No. 03-04  
Supersedes  
TN No. 91-50

Approval Date: **NOV 18 2003**

Effective Date 8/13/2003  
HCFA ID: 7982E

Revision: HCFA-PM-91-9 (MB)  
October 1991

OMB No.:

State/Territory: North Carolina

statutory or recognized by the courts)  
concerning advance directives; and

- (a) Provide (individually or with others) for education for staff and the community on issues concerning advance directives.
- (2) Providers will furnish the written information described in paragraph (1)(a) to all adult individuals at the time specified below:
  - (a) Hospitals at the time an individual is admitted as an inpatient.
  - (b) Nursing facilities when the individual is admitted as a resident.
  - (c) Providers of home health care or personal care services before the individual comes under the care of the provider;
  - (d) Hospice program at the time of initial receipt of hospice care by the individual from the program; and
  - (e) Managed care organizations, health insuring organizations, prepaid inpatient health plans, and prepaid ambulatory health plans (as applicable) at the time of enrollment of the individual with the organization.
- (3) Attachment 4.34A describes law of the State (whether statutory or as recognized by the courts of the State) concerning advance directives.

\_\_\_ Not applicable. No State law or court decision exist regarding advance directives.

TN No. 03-04  
Supersedes  
TN No. 91-50

Approval Date: **NOV 18 2003**

Effective Date: 8/13/2003  
HCFA ID: 7982E



Revision: HCFA-PM- 91-10 (MB)  
DECEMBER 1991

State/Territory: <u>North Carolina</u>	
<p>Citation 42 CFR 431.60 42 CFR 456.2 50 FR 15312 1902(a)(30)(C) and 1902(d) of the Act, P.L. 99-509 (Section 9431)</p>	<p>4.14 <u>Utilization/Quality Control</u> (a) A Statewide program of surveillance and utilization control has been implemented that safeguards against unnecessary or inappropriate use of Medicaid services available under this plan and against excess payments, and that assesses the quality of services. The requirements of 42 CFR part 456 are met:</p> <p style="margin-left: 40px;"><u>X</u> Directly</p> <p style="margin-left: 40px;">— By undertaking medical and utilization review requirements through a contract with a Utilization and Quality Control Peer Review Organization (PRO) designated under 42 CFR Part 462. The contract with the PRO--</p> <p style="margin-left: 80px;">(1) Meets the requirements of 434.6(a);</p> <p style="margin-left: 80px;">(2) Includes a monitoring and evaluation plan to ensure satisfactory performance;</p> <p style="margin-left: 80px;">(3) Identifies the services and providers subject to PRO review;</p> <p style="margin-left: 80px;">(4) Ensures that PRO review activities are not inconsistent with the PRO review of Medicare services; and</p> <p style="margin-left: 80px;">(5) Includes a description of the extent to which PRO determinations are considered conclusive for payment purposes.</p>
<p>1932 (c)(2) and 1902(d) of the ACT, P.L. 99-509 (Section 9431)</p>	<p><u>X</u> A qualified External Review Organization performs an annual External Quality Review that meets the requirements of 42 CFR 438 Subpart E, each managed care organization, prepaid inpatient health plan and health insuring organization under contract except where exempted by the regulation.</p>

---

---

TN No. 03-04

Supersedes

TN No. 92-12

Approval Date: **NOV 18 2003**

Effective Date 8/13/2003

Revision: HCFA-PM-85-3 (BERC)  
MAY 1985

State: \_\_\_\_\_ OMB No. 0938-0193

Citation  
42 CFR 456.2  
50 FR 15312

4.14 (b) The Medicaid agency meets the requirements of 42 CFR Part 456, Subpart C, for control of the utilization of inpatient hospital services.

\_\_\_ Utilization and medical review are performed by a Utilization and Quality Control Peer Review Organization designated under 42 CFR Part 462 that has a contract with the agency to perform those reviews.

\_\_\_ Utilization review is performed in accordance with 42 CFR Part 456, Subpart H, that specifies the conditions of a waiver of the requirements of Subpart C for:

\_\_\_ All hospitals (other than mental hospitals).

\_\_\_ Those specified in the waiver.

x  No waivers have been granted.

SENT BY OPC-11 # 86-04 DATED 5-13-86

R.Q. ACTION DATE 5-29-86 EFF. DATE 4-1-86

OBSOLETE BY \_\_\_\_\_ DATED \_\_\_\_\_

\_\_\_\_\_  
TN No. \_\_\_\_\_  
Supersedes Approval Date \_\_\_\_\_ Effective Date April 1, 1986  
TN No. \_\_\_\_\_

HCFA ID: 0048P/0002P

Revision: HCFA-PM-85-3  
MAY 1985

(BERC)

OMB NO. 0938-0193

State: \_\_\_\_\_

Citation  
42 CFR 456.2  
50 FR 15312

4.14 (c) The Medicaid agency meets the requirements of 42 CFR Part 456, Subpart D, for control of utilization of inpatient services in mental hospitals.

\_\_\_ Utilization and medical review are performed by a Utilization and Quality Control Peer Review Organization designated under 42 CFR Part 462 that has a contract with the agency to perform those reviews.

\_\_\_ Utilization review is performed in accordance with 42 CFR Part 456, Subpart H, that specifies the conditions of a waiver of the requirements of Subpart D for:

\_\_\_ All mental hospitals.

\_\_\_ Those specified in the waiver.

\_\_\_ No waivers have been granted.

SENT BY OPC-11 # 86-04 DATED 5-13-86

R.Q.ACTION DATE 5-29-86 EFF. DATE 4-1-86

OBSOLETE BY \_\_\_\_\_ DATED \_\_\_\_\_

\_\_\_\_\_  
TN No. \_\_\_\_\_  
Supersedes Approval Date \_\_\_\_\_ Effective Date \_\_\_\_\_  
TN No. \_\_\_\_\_

Revision: HCFA-PM-85-3  
MAY 1985

(BERC)

OMB NO. 0938-0193

State: \_\_\_\_\_

Citation  
42 CFR 456.2  
50 FR 15312

4.14 (d) The Medicaid agency meets the requirements of 42 CFR Part 456, Subpart E, for the control of utilization of skilled nursing facility services.

\_\_\_ Utilization and medical review are performed by a Utilization and Quality Control Peer Review Organization designated under 42 CFR Part 462 that has a contract with the agency to perform those reviews.

\_\_\_ Utilization review is performed in accordance with 42 CFR Part 456, Subpart H, that specifies the conditions of a waiver of the requirements of Subpart E for:

\_\_\_ All skilled nursing facilities.

\_\_\_ Those specified in the waiver.

x  No waivers have been granted.

SENT BY OPC-11 # 86-04 DATED 5-13-86

R.Q.ACTION DATE 5-29-86 EFF.DATE 4-1-86

OBSOLETE BY \_\_\_\_\_ DATED \_\_\_\_\_

TN No. \_\_\_\_\_  
Supersedes  
TN No. \_\_\_\_\_

Approval Date \_\_\_\_\_ Effective Date \_\_\_\_\_

Revision: HCFA-PM-85-3 (BERC)  
MAY 1985

OMB NO. 0938-0193

State: \_\_\_\_\_

Citation  
42 CFR 456.2  
50 FR 15312

4.14   x   (e) The Medicaid agency meets the requirements of 42 CFR Part 456, Subpart F, for control of the utilization of intermediate care facility services. Utilization review in facilities is provided through:

\_\_\_\_\_ Facility-based review.

\_\_\_\_\_ Direct review by personnel of the medical assistance unit of the State agency.

  X   Personnel under contract to the medical assistance unit of the State agency.

\_\_\_\_\_ Utilization and Quality Control Review organizations.

\_\_\_\_\_ Another method as described in ATTACHMENT 4.14-A.

\_\_\_\_\_ Two or more of the above methods. ATTACHMENT 4.14-B describes the circumstances under which each method is used.

\_\_\_\_\_ Not applicable. Intermediate care facility services are not provided under this plan.

SENT BY OPC-11 # 86-04 DATED 5-13-86

R.Q.ACTION DATE 5-29-86 EFF. DATE 4-1-86

OBSOLETE BY \_\_\_\_\_ DATED \_\_\_\_\_

TN No. \_\_\_\_\_  
Supersedes  
TN No. \_\_\_\_\_

Approval Date \_\_\_\_\_ Effective Date \_\_\_\_\_

HCFA ID: 0048P/0002P

Revision: HCFA-PM-92-2 (HSQB)  
MARCH 1992

State/Territory: North Carolina

<u>Citation</u>	4.15 <u>Inspection of Care in Intermediate Care Facilities for the Mentally Retarded, Facilities Providing Inpatient Psychiatric Services for Individuals Under 21, and Mental Hospitals</u>
42 CFR Part 456 Subpart I, and 1902(a)(31) and 1903(g) of the Act	<p>_____ The State has contracted with a Peer Review Organization (PRO) to perform inspection of care for:</p> <p>_____ ICFs/MR;</p> <p>_____ Inpatient psychiatric facilities for recipients under age 21; and</p> <p>_____ Mental Hospitals.</p>
42 CFR Part 456 Subpart A and 1902(a)(30) of the Act	<p><u>x</u> All applicable requirements of 42 CFR Part 456, Subpart I, are met with respect to periodic inspections of care and services.</p> <p>_____ Not applicable with respect to intermediate care facilities for the mentally retarded services; such services are not provided under this plan.</p> <p>_____ Not applicable with respect to services for individuals age 65 or over in institutions for mental disease; such services are not provided under this plan.</p> <p>_____ Not applicable with respect to inpatient psychiatric services for individuals under age 21; such services are not provided under this plan.</p>

TN No. 92-29  
Supersedes  
TN No. 76-10

Approval Date DEC 30 1992 Effective Date 10/1/92

HCFA ID:

Revision: HCFA-AT-80-38 (BPP)  
May 22, 1980

State North Carolina

Citation  
42 CFR 431.615(c)  
AT-78-90

4.16 Relations with State Health and Vocational Rehabilitation Agencies and Title V Grantees

The Medicaid agency has cooperative arrangements with State health and vocational rehabilitation agencies and with title V grantees, that meet the requirements of 42 CFR 431.615.

ATTACHMENT 4.16-A describes the cooperative arrangements with the health and vocational rehabilitation agencies.

TN # 74-25  
Supersedes  
TN # \_\_\_\_\_

Approval Date 8/19/74

Effective Date 7/1/74



Revision: HCFA-PM-95-3 (MB)  
MAY 1995

STATE PLAN UNDER TITLE XIX OF THE SOCIAL SECURITY ACT

State/Territory: North Carolina

Citation

42 CFR 433.36(c)  
1902(a)(18) and  
1917(a) and (b) of  
the Act

4.17 Liens and Adjustments or Recoveries

(a) Liens

\_\_\_\_\_ The State imposes liens against an individual's real property an account of medical assistance paid or to be paid.

The State complies with the requirements of section 1917(a) of the Act and regulations at 42 CFR 433.36(c)-(g) with respect to any lien imposed against the property of any individual prior to his or her death on account of medical assistance paid or to be paid on his or her behalf.

\_\_\_\_\_ The State imposes liens on real property on account of benefits incorrectly paid.

\_\_\_\_\_ The State imposes TEFRA liens 1917(a)(1)(B) on real property of an individual who is an inpatient of a nursing facility, ICF/MR, or other medical institution, where the individual is required to contribute toward the cost of institutional care all but a minimal amount of income required for personal needs.

The procedures by the State for determining that an institutionalized individual cannot reasonably be expected to be discharged are specified in Attachment 4.17-A. (NOTE: If the State indicates in its State plan that it is imposing TEFRA liens, then the State is required to determine whether an institutionalized individual is permanently institutionalized and afford these individuals notice, hearing procedures, and due process requirements.)

\_\_\_\_\_ The State imposes liens on both real and personal property of an individual after the individual's death.

TN No. 96-02  
Supersedes  
TN No. 83-01

Approval Date 9-28-96

Effective Date 10-01-94

Revision: HCFA-PM-95-3 (MB)  
MAY 1995

STATE PLAN UNDER TITLE XIX OF THE SOCIAL SECURITY ACT

State/Territory: North Carolina

(b) Adjustments or Recoveries

The State complies with the requirements of section 1917(b) of the Act and regulations at 42 CFR 433.36(h)-(i).

Adjustments or recoveries for Medicaid claims correctly paid are as follows:

- (1) For permanently institutionalized individuals, adjustments or recoveries are made from the individual's estate or upon sale of the property subject to a lien imposed because of medical assistance paid on behalf of the individual for services provided in a nursing facility, ICF/MR, or other medical institution.
- X Adjustments or recoveries are made for all other medical assistance paid on behalf of the individual.
- (2) x The State determines "permanent institutional status" of individuals under the age of 55 other than those with respect to whom it imposes liens on real property under 1917(a)(1)(B) (even if it does not impose those liens).
- (3) For any individual who received medical assistance at age 55 or older, adjustments or recoveries of payments are made from the individual's estate for nursing facility services, home and community-based services, and related hospital and prescription drug services.
- X In addition to adjustment or recovery of payments for services listed above, payments are adjusted or recovered for other services under the State plan as listed below:

There is no additional recovery for provided Medicaid services.

---

TN No. 10-039  
Supersedes  
TN No. 96-02

Approval Date: 03-25-11

Effective Date 10/01/2010

Revision: HCFA-PM-95-3 (MB) MAY 1995

STATE PLAN UNDER TITLE XIX OF THE SOCIAL SECURITY ACT

State/Territory: North Carolina

4.17 Liens and Adjustments or Recoveries

(b) Adjustments or Recoveries

(3) (continued)

Limitations on Estate Recovery - Medicare Cost Sharing:

- (i) Medical assistance for Medicare cost sharing is protected from estate recovery for the following categories of dual eligibles: QMB, SLMB, QI, QDWI, QMB+, SLMB+. This protection extends to medical assistance for four Medicare cost sharing benefits: (Part A and B premiums, deductibles, coinsurance, co-payments) with dates of service on or after January 1, 2010. The date of service for deductibles, coinsurance, and co-payments is the date the request for payment is received by the State Medicaid Agency. The date of service for premiums is the date the State Medicaid Agency paid the premium.
- (ii) In addition to being a qualified dual eligible the individual must also be age 55 or over. The above protection from estate recovery for Medicare cost sharing benefits (premiums, deductibles, coinsurance, co-payments) applies to approved mandatory (i.e., nursing facility, home and community-based services, and related prescription drugs and hospital services as well as optional Medicaid services identified in the State plan, which are applicable to the categories of duals referenced above.

TN No. 10-039  
Supersedes  
TN No. NEW

Approval Date: 03-25-11

Effective Date: 10/01/2010

Revision: HCFA-PM-95-3 (MB)  
MAY 1995

STATE PLAN UNDER TITLE XIX OF THE SOCIAL SECURITY ACT

State/Territory: North Carolina

- (4)  The State disregards assets or resources for individuals who receive or are entitled to receive benefits under a long term care insurance policy as provided for in Attachment 2.6-A, Supplement 8b.
- The State adjusts or recovers from the individual's estate on account of all medical assistance paid for nursing facility and other long term care services provided on behalf of the individual. (States other than California, Connecticut, Indiana, Iowa, and New York which provide long term care insurance policy--based asset or resource disregard must select this entry. These five States may either check this entry or one of the following entries.)
- The State does not adjust or recover from the individual's estate on account of any medical assistance paid for nursing facility or other long term care services provided on behalf of the individual.
- The State Adjusts or recovers from the assets or resources on account of medical assistance paid for nursing facility or other long term care services provided on behalf of the individual to the extent described below:
- 1917(b)1(c)  If an individual covered under a long-term care insurance policy received benefits for which assets or resources were disregarded as provided for in Attachment 2.6-A, Supplement 8c (State Long-Term Care Insurance Partnership), the State does not seek adjustment or recovery from the individual's estate for the amount of assets or resources disregarded.

Revision: HCFA-PM-95-3 (MB)  
MAY 1995

STATE PLAN UNDER TITLE XIX OF THE SOCIAL SECURITY ACT

State/Territory: North Carolina

(c) Adjustments or Recoveries: Limitations

The State complies with the requirements of section 1917(b)(2) of the Act and regulations at 42 CFR 433.36(h)-(i).

- (1) Adjustment or recovery of medical assistance correctly paid will be made only after the death of the individual's surviving spouse, and only when the individual has no surviving child who is either under age 21, blind, or disabled.
- (2) With respect to liens on the home of any individual who the State determines is permanently institutionalized and who must as a condition of receiving services in the institution apply their income to the cost of care, the State will not seek adjustment or recovery of medical assistance correctly paid on behalf of the individual until such time as none of the following individuals are residing in the individual's home:
  - (a) a sibling of the individual (who was residing in the individual's home for at least one year immediately before the date that the individual was institutionalized), or
  - (b) a child of the individual (who was residing in the individual's home for at least two years immediately before the date that the individual was institutionalized) who establishes to the satisfaction of the State that the care the child provided permitted the individual to reside at home rather than become institutionalized.
- (3) No money payments under another program are reduced as a means of adjusting or recovering Medicaid claims incorrectly paid.

TN No. 96-02  
Supersedes  
TN No. New

Approval Date: 9-28-96

Effective Date 10-01-94

Revision: HCFA-PM-95-3 (MB)  
MAY 1995

STATE PLAN UNDER TITLE XIX OF THE SOCIAL SECURITY ACT

State/Territory: North Carolina

(d) ATTACHMENT 4.17-A

- (1) Specifies the procedures for determining that an institutionalized individual cannot reasonably be expected to be discharged from the medical institution and return home. The description of the procedure meets the requirements of 42 CFR 433.36(d).
- (2) Specifies the criteria by which a son or a daughter can establish that he or she has been providing care, as specified under 42 FR 433.36(f).
- (3) Defines the following terms:
  - estate (at a minimum, estate as defined under State probate law). Except for the grandfather States listed in section 4.17 (b) (3), if the State provides a disregard for assets or resources for any individual who received or is entitled to receive benefits under a long term care insurance policy. The definition of estate must include all real, personal properties, and assets of an individual including any property or assets in which the individual had any legal title or interest at the time of death to the extent of the interest and also including the assets conveyed through devices such as joint tenancy, life, estate, living trust, or other arrangement),
  - individual's home,
  - equity interest in the home,
  - residing in the home for at least 1 or 2 years,
  - on a continuous basis,
  - discharge from the medical institution and return home, and
  - lawfully residing.

TN No. 96-02  
Supersedes  
TN No. New

Approval Date 09-28-96

Effective Date 10-01-94

Revision: HCFA-PH-95-3 (MB)  
MAY 199S

STATE PLAN UNDER TITLE XIX OF THE SOCIAL SECURITY ACT

State/Territory: North Carolina

- (4) Describes the standards and procedures for waiving estate recovery when it would cause undue hardship.
- (5) Defines when adjustment or recovery is not cost-effective. Defines cost effective and includes methodology or thresholds used to determine cost effectiveness.
- (6) Describes collection procedures. Includes advance notice requirements, specifies the method for applying for a waiver, hearing and appeals procedures, and the time frames involved.

---

TN No. 96-02  
Supersedes  
TN No. New

Approval Date: 9-28-96

Effective Date 10-01-94

Revision: HCFA-PM-91-4 (BPD) OMB No. 0938-  
AUGUST 1991

State/Territory North Carolina

Citation 4.18 Recipient-Cost Sharing and Similar Charges

42 CFR 447.51  
Through 447.58

(a) Unless a waiver under 42 CFR 431-55(g) applies, deductibles, coinsurance rates and co-payments do not exceed the maximum allowable charges under 42 CFR 447.54.

1916(a) and (b)  
of the Act

(b) Except as specified in items 4.18(b)(4),(5) and (6) below, with respect to individuals covered as categorically needy or as qualified Medicare Beneficiaries (as defined in section 1905(p)(1) of the Act) under the plan:

(1) No enrollment fee, premium, or similar charge is imposed under the plan.

(2) No deductible, coinsurance, co-payment, or similar charge is imposed under the plan for the following:

(i) Services to individuals under age 18, or under--

- Age 19
- Age 20
- Age 21

Reasonable categories of individuals who are age 18 or older, but under age 21, to whom charges apply are listed below, if applicable.

(ii) Services to pregnant women related to the pregnancy or any other medical condition that may complicate the pregnancy.

---

TN No. 03-04

Supersedes Approval Date: NOV 18 2003

Effective Date 8/13/2003

TN No. 92-01

HCFA ID: 7982E



Revision: HCFA-PM-91-4 (BPD)  
AUGUST 1991

OMB No.: 0938-

State/Territory: North Carolina

Citation

4.18(b)(2) (Continued)

42 CFR 447.51  
Through  
447.58

(iii) All services furnished to pregnant women.

— Not applicable. Charges apply for services to pregnant women unrelated to the pregnancy.

(iv) Services furnished to any individual who is an inpatient in a hospital, long-term care facility, or other medical institution, if the individual is required, as a condition of receiving services in the institution, to spend for medical care costs all but a minimal amount of his or her income required for personal needs.

(v) Emergency services if the services meet the requirements in 42 CFR 447-53(b)(4).

(vi) Family planning services and supplies furnished to individuals of childbearing age.

(vii) Services furnished by a managed care organization, health insuring organization, prepaid inpatient health plan, or prepaid ambulatory health plan in which the individual is enrolled, unless they meet the requirements of 42 CFR 447.60.

42 CFR 438.108  
42 CFR 447.60

— Managed Care enrollee are charged deductibles, coinsurance rates, and copayments in an amount equal to the State Plan service cost-sharing.

X Managed Care enrollees are not charged deductibles, coinsurance rates, and copayments.

1916 of the Act,  
P.L. 99-272,  
(Section 9505)

(viii) Services furnished to an individual receiving hospice care, as defined in section 1905(o) of the Act.

TN No. 03-04  
Supersedes  
TN No. 92-01

Approval Date: **NOV 18 2003**

Effective Date **8/13/2003**  
HCFA ID: 7982E

Revision: HCFA-PM-91- 4 (BPD)  
AUGUST. 19 9 1

OMB No 0938-

State/Territory: North Carolina

Citation 4.18(b) (Continued)

42 CFR 447.51 (3) Unless a waiver under 42 CFR 431.55(g) through 447.48 applies, nominal deductible, coinsurance, copayment, or similar charges are imposed for services that are not excluded from such charges under item (b)(2) above.

\_\_\_\_ Not applicable. No such charges are imposed.

(i) For any service, no more than one type of charge is imposed.

(ii) Charges apply to services furnished to the following age groups:

- 18 or older
- 19 or older
- 20 or older
- 21 or older

x Charges apply to services furnished to the following reasonable categories of individuals listed below who are 18 years of age or older but under age 21.

All individuals 18 yrs or older for all covered services other than those related to pregnancy or EPSDT, SNF, ICF, ICF-MR, mental hospital patients, and hospital emergency rooms.

TN No. 92-01  
Supersedes  
TN No. 86-19

Approval Date 10-21-92

Effective Date 1/1/92  
HCFA ID:7982E

Revision: HCFA-PM-91- 4 (BPD)  
AUGUST 19 9 1

OMB No. 0938-

State/Territory: North Carolina

Citation  
42 CFR 447.51  
through 447.58

4.18(b)(3) (Continued)

(111) For the categorically needy and qualified Medicare beneficiaries, ATTACHMENT 4.18-A specifies the:

- (A) Service(s) for which a charge(s) is applied;
- (B) Nature of the charge imposed on each service;
- (C) Amount(s) of and basis for determining the charge(s);
- (D) Method used to collect the charge(s);
- (E) Basis for determining whether an individual is unable to pay the charge and the means by which such an individual is identified to providers;
- (F) Procedures for implementing and enforcing the exclusions from cost sharing contained in 42 CFR 447.53(b); and
- (G) Cumulative maximum that applies to all deductible, coinsurance or copayment charges imposed on a specified time period.

X  Not applicable. There is no maximum.

TN No. 92-01  
Supersedes  
TN No. 90-9

Approval Date 10-21-92

Effective Date 1/1/92

HCFA ID: 7982E

Revision: HCFA-PM-91- & (BPD)  
AUGUST 1991

OMB No. 0938-

State/Territory: North Carolina

Citation 1916(c) Of the Act	4-18(b)(4) _____	A monthly premium is imposed on pregnant women and infants who are covered under section 1902(a)(10) (A) (ii)(IX) of the Act and whose income equals or exceeds 150 percent of the Federal poverty level applicable to a family of the size involved. The requirements of section 1916(c) of the Act are met. ATTACHMENT 4-18-D specifies the method the State uses for determining the premium and the criteria for determining what constitutes undue hardship for waiving payment of premium by recipients.
1902(a)(52) and 1925(b) of the Act	4.18(b)(5) _____	For families receiving extended benefits during a second 6-month period under section 1925 of the Act, a monthly premium is imposed in accordance with sections 1925 (b)(4) and (5) of the Act.
1916(d) of the Act	4.18(b)(6) _____	A monthly premium, set on a sliding scale, imposed on qualified disabled and working Individuals who are covered under section 1902(a)(10)(E) (ii) of the Act and whose income exceeds 150 percent (but does not exceed 200 percent) of the Federal poverty level applicable to a family of the size involved. The requirements of section 1916(d) of the Act are met. ATTACHMENT 4.18-E specifies the method and standards the State uses for determining the premium.

TN No. 92-01  
Supersedes  
TN No. 86-19

Approval Date 10-21-92

Effective Date 1/1/92

HCFA ID: 7982E

Revision: HCFA-PM-91- 4 (BPD)  
AUGUST 1991

OMB No.:0938-

State/Territory: North Carolina

Citation	4.18(c)	<u>x</u>	Individuals are covered as medically needy under the plan.
42 CPR 447.51 through 447.58		(1) <u>    </u>	An enrollment fee, premium or similar charge is imposed. <u>ATTACHMENT 4.18-8</u> specifies the amount of and liability period for such charges subject to the <u>maximum allowable charges</u> in 42 CPR 447.52(b) and defines the State's policy regarding the effect on recipients of non-payment of the enrollment fee, premium, or similar charge.
447.51 through 447.58		(2)	No deductible, coinsurance, copayment, or similar charge is imposed under the plan for the following:
		(i)	Services to individuals under age 18, or under--
		<u>    </u>	Age 19
		<u>    </u>	Age 20
		<u>    </u>	Age 21
			Reasonable categories of individuals who are age 18, but under age 21, to whom charges apply are listed below, if applicable:
			All individuals 18 yrs or older for all covered services other than those related to pregnancy or EPSDT# SNF ICF# ICF-MR, mental hospital patients and hospital emergency rooms.

TN No.92-01  
Supersedes  
TN No.86-19

Approval Date 10-21-92

Effective Date 1/1/92  
HCFA ID: 7982E

Revision: HCFA-PH-91-4 (BPD)  
AUGUST 1991

OMB No.0939-

State/Territory: North Carolina

Citation 4.18 (c)(2) (continued)

42 CFR 447.51  
through  
447.58

(ii) Services to pregnant women related to the pregnancy or any other medical condition that may complicate the pregnancy.

(iii) All services furnished to pregnant women.

— Not applicable. Charges apply for services to pregnant women unrelated to the pregnancy.

(iv) Services furnished to any individual who is an inpatient in a hospital, long-term care facility, or other medical institution, if the individual is required, as a condition of receiving services in the institution, to spend for medical care costs all but a minimal amount of his income required for personal needs.

(v) Emergency services if the services meet the requirements in 42 CFR 447.53(b)(4).

(vi) Family planning services and supplies furnished to individuals of childbearing age.

1916 of the Act,  
P.L. 99-272  
(Section 9505)

(vii) Services furnished to an individual receiving hospice care, as defined in section 1905(o) of the Act.

447.51 through  
447.58

(viii) Services provided by a health maintenance organization (HMO) to enrolled individuals.

X Not applicable. No such charges are imposed.

TN No. 92-01  
Supersedes  
TN No. 86-19

Approval Date 10-21-92 Effective Date 1/1/92

HCFA ID: 7982E

Revision: HCFA-M-1- (BPD)  
AUGUST 1991

OMB No.: 0938-

State/Territory: North Carolina

Citation 4.18(c)(3) Unless a waiver under 42 CFR 431-5(g) applies, nominal deductible, coinsurance copayment, or similar charges are imposed on services that are not excluded from such charges under item (b)(2) above.

X Not applicable. No such charges are imposed.

(i) For any service, no more than one type of charge is imposed.

(ii) Charges apply to services furnished to the following age group:

     18 or older

     19 or older

     20 or older

     21 or older

Reasonable categories of individuals who are 18 years of age, but under 21, to whom charges apply are listed below, if applicable.

All individuals 18 yr or older for all covered services other than those related to pregnancy or EPSM SNF, IM, ICF-M, mental hospital patients, and hospital emergency rooms.

TN No. 92-01  
Supersedes  
TN No. 86-19

Approval Date 10-21-92

Effective Date 1/1/92

HCFA ID: 7982E

Revision: HCFA-PM-91- 4 (BPD)  
AUGUST 1991

OMB No. 0938-

State/Territory: North Carolina

Citation 4.18(c)(3) (Continued)

- 447.51 through (iii) For the medically needy, and other optional groups, ATTACHMENT 4.18-C specifies the:
- 447.58 (A) Service(s) for which charge(s) is applied;
- (B) Nature of the charge imposed on each service;
- (C) Amount(s) of and basis for determining the charge(s);
- (D) Method used to collect the charge(s);
- (E) Basis for determining whether an Individual is unable to pay the charge(s) and the means by which such an individual is identified to providers;
- (F) Procedures for implementing and enforcing the exclusions from cost sharing contained in 42 CFR 447.53(b); and
- (G) Cumulative maximum that applies to all deductible, coinsurance or copayment charges imposed on a family during a specified time period.
- X Not applicable. There is no maximum.

---

TN No. 92.01

Supersedes

Approval Date 10-21-92

Effective Date 1/1/92

TN No. 86-19

HCFA ID: 7982E



Revision: HCFA-PM-91-4 (BPD)  
AUGUST 1991

014B No. 0938-

State/Territory: North Carolina

Citation 4.19 Payment for Services

42 CFR 447.252 (a) The Medicaid agency meets the  
1902(a)(13) requirements of 42 CFR Part 447, Subpart  
and 1923 of C, and sections 1902(a)(13) and 1923 of  
the Act 1902 the Act with respect to payment for  
(e)(7) of the Act inpatient hospital services.

ATTACHMENT 4-19-A describes the methods and standards used to determine rates for payment for inpatient hospital services.

X Inappropriate level of care days are covered and are paid under the State plan at lower rates than other inpatient hospital services, reflecting the level of care actually received, in a manner consistent with section 1861(v)(1)(G) of the Act.

       Inappropriate level of care days are not covered.

TN No. 92-01  
Supersedes  
TN No. 87-5

Approval Date 10-21-92

Effective Date 1/1/92

HCFA ID: 7982E

Revision: HCFA-PM-93-6  
August 1993

(MB)

OMB No.: 0938

State/Territory: North Carolina

Citation  
42 CFR 447.201  
42 CFR 447.302  
52 FR 28648  
1902(a)(13)(E)  
1903(a)(1) and  
(n), 1920, and  
1926 of the Act

4.19 (b)

In addition to the services specified in paragraphs 4.19(a), (d), (k), (l), and (m), the Medicaid agency meets the following requirements:

- (1) Section 1902(a)(13)(E) of the Act regarding payment for services furnished by Federally qualified health centers (FQHCs) under section 1905(a)(2)(C) of the Act. The agency meets the requirements of section 6303 of the State Medicaid Manual (HCFA-Pub. 45-6) regarding, payment for FQHC services. ATTACHMENT 4.19-B describes the method of payment and how the agency determines the reasonable costs of the services (for example, cost-reports, cost or budget reviews, or sample surveys).
- (2) Sections 1902 (a) (13) (E) and 1926 of the Act, and 42 CFR Part 447, Subpart 0, with respect to payment for all other types of ambulatory services provided by rural health clinics under the plan.

ATTACHMENT 4.19-B describes the methods and standards used for the payment of each of these services except for inpatient hospital, nursing facility services and services in intermediate care facilities for the mentally retarded that are described in other attachments.

1902(a)(10) and  
1902(a)(30) of  
Act

SUPPLEMENT 1 to ATTACHMENT 4.19-B describes general methods and standards used for the establishing payment for Medicare Part A and B deductible/coinsurance.

---

No. 93-20

Supersedes

Approval Date NOV 5, 1993

Effective Date 7-1-93

TN No. 92-01

Revision: HCFA-AT-80-38(BPP)  
May 22, 1980

State North Carolina

---

Citation  
42 CFR 447.40  
AT-78-90

4.19-C

Payment is made to reserve a bed during a recipient's temporary absence from an inpatient facility.

- Yes. The State's policy is described in ATTACHMENT 4.19-C.
- No.

Revision: HCFA-PH-87-9 (BERC)  
AUGUST 1987

OMB No.: 0938-0193

State/Territory: North Carolina

Citation 4.19 (d)

42 CFR 447.252

47 FR 47964

48 FR 56046

42 CFR 447.280

47 FR 31518

52 FR 28141

x (1)

The Medicaid agency meets the requirements of 42 CFR Part 447, Subpart C, with respect to payments for skilled nursing and intermediate care facility services.

ATTACHMENT 4.19-D describes the methods and standards used to determine rates for payment for skilled nursing and intermediate care faculty services.

(2) The Medicaid agency provides payment for routine skilled nursing facility services furnished by a swing-bed hospital.

\_\_\_ At the average rate per patient day paid to SNFs for routine services furnished during the previous calendar year.

X At a rate established by the State, which meets the requirements of 42 CFR Part 447, Subpart C, as applicable.

\_\_\_ Not applicable. The agency does not provide payment for SNF services to a swing-bed hospital.

(3) The Medicaid agency provides payment for routine intermediate care facility services furnished by a swing-bed hospital.

\_\_\_ At the average rate per patient day routine paid to ICFs, other than ICFs for the mentally retarded, for routine services furnished during the previous calendar year.

X At a rate established by the State, which meets the requirements of 42 CFR Part 447 Subpart C, as applicable.

\_\_\_ Not applicable. The agency does not provide payment for ICF services to a swing-bed hospital.

\_\_\_ (4) Section 4.19(d)(1) of this plan is not applicable with respect to intermediate care facility services: such services are not provided under this State plan.

TN No. 91-15

Supersedes

TN No. 87-12

Approval Date 9-24-91

Effective Date 7-1-91

HCFA 10: 1010P/0012P

Revision: HCFA-AT-80-38(BPP)  
May 22, 1980

State North Carolina

Citation 4.19(e) The Medicaid agency meets all  
42 CTR 447.45(c) requirements of 42 CFR 447.45 for  
AT-79-50 timely payment of claims.

ATTACHMENT 4.19-E specifies, for each  
type of service, the definition of a  
claim for purposes of meeting these  
requirements.

---

TN 79-17  
Supersedes Approval Date 11/30/79 Effective Date 8/23/79  
TN # \_\_\_\_\_

Revision: HCFA-PM-87-4 (BERC)  
MARCH 1987

OMB No.: 0938-0193

State/Territory: North Carolina

---

Citation  
42 CFR 447.15  
AT-78-90  
AT-80-34  
48 FR 5730

4.19 (f)

The Medicaid agency limits participation to providers who meet the requirements of 42 CFR 447.15

No provider participating under this plan may deny services to any individual eligible under the plan on account of the individual's inability to pay a cost sharing amount imposed by the plan in accordance with 42 CFR 431.55(g) and 447.53. This service guarantee does not apply to an individual who is able to pay, nor does an individual's inability to pay eliminate his or her liability for the cost sharing change.

---

TN No. 87-5  
Supersedes  
TN No. 83-07

Approval Date Jul 23 1987

Effective Date 4/1/87

HCFA ID: 1010P/0012P

Revision: HCFA-AT-80-38 (BPP)  
May 22, 1980

State North Carolina

Citation	4.19(g)	The Medicaid agency assures
42 CER 447.201		appropriate audit of records when
42 CFR 447.202		payment is based on costs of
AT-78-90		services or on a fee plus cost of
		materials.

---

TN # <u>79-12</u>	Approval Date <u>7/31/79</u>	Effective Date <u>8/6/79</u>
Supersedes		
TN # _____		

Revision: HCFA-AT-80-60 (BPP)  
August 12, 1980

State North Carolina

---

Citation	4.19 (h)	The Medicaid agency meets the
42 CER 447.201		requirements of 42 CFR 447.203 for
42 CFR 447.203		documentation and availability of.
AT-78-90		payment rates

---

TN #79-12

Supersedes

TN # \_\_\_\_\_

Approval Date 7/31/79

Effective Date 8/6/79



Revision: HCFA-AT-80-38 (BPP)  
 May 22, 1980

State North Carolina

Citation	4.19(i)	The Medicaid agency's payments are sufficient to enlist enough providers so that services under the plan are available to recipients at least to the extent that those services are available to the general population.
42 CFR 447.201		
42 CFR 447.204		
AT-78-90		

---

TN #79-12

Supersedes

Approval Date

7/31/79

Effective Date 8/1/79

TN # \_\_\_\_\_

Revision: HCFA-PM-91-4 (BPD)  
AUGUST 1991

OMB No.: 0938-

State: North Carolina

Citation

42 CFR  
447.201  
and 447.205

4.19(j)

The Medicaid agency meets the requirements of 42 CFR 447.205 for public notice of any changes in Statewide method or standards for setting payment rates.

1903(v) of the  
Act

(k)

The Medicaid agency meets the requirements of section 1903(v) of the Act with respect to payment for medical assistance furnished to an alien who is not lawfully admitted for permanent residence or otherwise permanently residing in the United States under color of law. Payment is made only for care and services that are necessary for the treatment of an emergency medical condition, as defined in section 1903(v) of the Act.

TN No. 92-01  
Supersedes  
TH No. 87-12

Approval Date 10-21-92

Effective Date 1/1/92

HCFA ID: 7982E

Revision: HCFA-PM-94-8  
OCTOBER 1994

State/Territory; NORTH CAROLINA

Citation

SOCIAL SECURITY ACT 1915 (a)

4.19 (m) Medicaid Reimbursement for Administration of Vaccines under the Pediatric Immunization Program

1928(c)(2)  
(C)(ii) of  
the Act

(i) A provider may impose a charge for the administration of a qualified pediatric vaccine as stated in 1928(c)(2)(C)(ii) of the Act. within this overall provision, Medicaid, reimbursement to providers will be, administered as follows.

(ii) The State:

  x   sets a payment rate at the level of the regional maximum established by the DHHS Secretary.

       is a Universal Purchase State and sets a payment rate at the level of the regional maximum established in accordance with state law.

       sets a payment rate below the level of the regional maximum established by the DHHS Secretary.

       is a Universal Purchase State and sets a payment rate below the level of the region" maximum established by the Universal Purchase State.

The state pays the following rate for the administration of a vaccine:

1926 of (iii) Medicaid beneficiary access to immunizations the Act is assured through the following methodology:

Other

TN No. 11-021  
Supersedes  
TN No. 94-35

Approval Date: 12-21-11 Effective Date 07/12/2011

Revision: HCFA-AT-80-38 (BPP)  
May 22, 1980

State North Carolina

Citation  
42 CFR 447.25(b)  
AT-78-90

4.20 Direct Payments to Certain Recipients  
for Physicians' or Dentists' Services

Direct payments are made to certain recipients as specified by, and in accordance with, the requirements of 42 CFR 447.25.

Yes, for  physicians' services  
 dentists' services

ATTACHMENT 4.20-A specifies the conditions under which such payments are made.

Not applicable. No direct payments are made to recipients.

TN #79-21  
Supersedes  
TN # \_\_\_\_\_

Approval Date 11/19/79

Effective Date 10/1/79

Revision: HCFA-AT-81-34 (BPP)

10-81

State North Carolina

Citation 4.21 Prohibition Against Reassignment of  
Provider Claims

42 CFR 447.10(c)  
AT-78-90  
46 FR 42699

Payment for Medicaid services  
furnished by any provider under this plan is  
made only in accordance with the requirements  
of 42 CFR 447.10.

---

TN # \_\_\_\_\_  
Supersedes Approval Date \_\_\_\_\_ Effective Date \_\_\_\_\_  
TN # \_\_\_\_\_

SENT BY OPC-11 # 81-13 DATED 12-30-81

R. 0. ACTION DATE 1-8-82 EFF. DATE 1-1-82

OBSOLETE BY \_\_\_\_\_ DATED \_\_\_\_\_

Revision: HCFA-PM-94-1 (MB)  
FEBRUARY 1994

State/Territory: North Carolina

Citation 4.22 Third Party Liability

- 42 CFR 433.137 (a) The Medicaid agency meets all requirements of:
- (1) 42 CFR 433.138 and 433.139.
  - (2) 42 CFR 433.145 through 433.148.
  - (3) 42 CFR 433.151 through 433-154.
  - (4) Sections 1902(a)(25)(H) and (1) of the Act.
- 1902(a)(25)(H) and (I) Act.
- 42 CFR 433.138(f) (b) ATTACHMENT 4.22-A -
- (1) Specifies the frequency with which the data exchanges required in §433.138(d)(1), (d)(3) and (d)(4) and the diagnosis and trauma code edits required in §433.138(e) are conducted;
  - (2) Describes the methods the agency uses for meeting the follow-up requirements contained in §433. 138 (g)(1)(i) and (g)(2)(i);
  - (3) Describes the methods the agency uses for following up on information obtained through the State motor vehicle accident report file data exchange required under §433.138(d)(4) (ii) and specifies the time frames for incorporation into the eligibility case file and into its third party data base and third party recovery unit of all information obtained through the follow up that identifies legally liable third party resources; and
  - (4) Describes the methods the agency uses for following up on paid claims identified under §433.138(e) (methods include a procedure for periodically identifying those trauma codes that yield the highest third party collections and giving priority to following up on those codes) and specifies the time frames for incorporation into the eligibility case file and into its third party data base and third party recovery unit of all information obtained through the follow up that identifies legally liable third party resources.
- 42 CFR 433.138(g)(1)(ii) and (2)(ii)
- 42 CFR 433.138(g)(3)(i) and (UL)
- 42 CFR 433.138(g)(4)(i) through (iii)

TN No. 94-11  
Supersedes  
TN No. 90-07

Approval Date 8-15-94

Effective Date 4/1/94

Revision: HCFA-PM-94-1 (MB)  
FEBRUARY 1994

State/Territory: North Carolina

Citation

- 42 CFR 433.139(b)(3) \_\_\_\_\_ (c) Providers are required to bill  
(ii) (A) liable third parties when services  
covered under the plan are furnished to  
an individual on whose behalf child  
support enforcement is being carried out  
by the State IV-D agency.
- (d) ATTACHMENT 4.22-B specifies the  
following:
- 42 CFR 433.139(b)(3)(ii)(C) (1) The method used in  
determining a provider's  
compliance with the third party  
billing requirements at  
§433.139(b)(3)(ii)(C).
- 42 CFR 433.139(f)(2) (2) The threshold amount or other  
guideline used in determining  
whether to seek recovery of  
reimbursement from liable third  
party, or the process by which the  
agency determines that seeking  
recovery of reimbursement would  
not be cost effective.
- 42 CFR 433.139(f)(3) (3) The dollar amount or time  
period the State uses to  
accumulate billings from a  
particular liable third party in  
making this decision to seek  
recovery of reimbursement.
- 42 CFR 447.20 (e) The Medicaid agency ensures that  
the provider furnishing a service for  
which a third party is liable follows  
the restrictions specified in 42 CFR  
447.20.

TN No. 94-11  
Supersedes  
TN No. 90-07

Approval Date 8-15-94

Effective Date 4/1/94

Revision: HCFA-PM-94-1 (MB)  
FEBRUARY 1994

State/Territory: North Carolina

Citation

4.22 (continued):

42 CFR 433.151(a) (f) The Medicaid agency has written cooperative agreements for the enforcement of rights to and collection of third party benefits assigned to the State as a condition of eligibility for medical assistance with the following:(Check as appropriate.)

\_\_\_ State title IV-D agency. The requirements of 42 CFR 433.152 (b) are met.

\_\_\_ Other appropriate State agency(s)--  
\_\_\_\_\_  
\_\_\_\_\_

\_\_\_ Other appropriate agency(s) of another State--  
\_\_\_\_\_  
\_\_\_\_\_

\_\_\_ Courts and law enforcement officials.

1902(a)(60) of the Act (g) The Medicaid agency assures that the State has in effect the laws relating to medical child support under section 1908 of the Act.

1906 of the Act (h) The Medicaid, agency specifies the guidelines used in determining the cost effectiveness of an employer-based group health plan by selecting one of the following.

\_\_\_ The Secretary's method as provided in the State Medicaid Manual, Section 3910.

\_\_\_ The State provides methods for Determining cost effectiveness on ATTACHMENT 4.22-C.

TN No. 94-11  
Supersedes  
TN No. 90-07

Approval Date 8-15-94

Effective Date 4/1/94



Revision: HCFA-PM-94-2 (SPD)  
APRIL 1994

State/Territory: North Carolina

<p><u>Citation</u> 42 CFR 442-10 and 442.100 AT-72-90 AT-79-18 AT-80-25 AT-80-34 S2 FR 32544 P.L 100-203 (Sec. 4211) 54 FR 5316 56 FR 48826</p>	<p>4.24</p>	<p><u>Standards for Payments for Nursing Facility and Intermediate Care Facility for the Mentally Retarded Services</u></p> <p>With respect to nursing facilities and intermediate care facilities for the mentally retarded, all applicable requirements of 42CFR Part 442, Subparts B and C are met.</p> <p>— Not applicable to intermediate care facilities for the mentally retarded; such services are not provided under this plan</p>
---	-------------	--

No. 94-17  
Supersedes  
TN 88-03

Approval Date June 14 1994

Effective Date 4/1/94

Revision: HCFA-AT-80-38(BPP)  
May 22, 1980

State North Carolina

Citation  
42 CFR 431.702  
AT-78-90

4.25 Program for Licensing Administrators of  
Nursing Homes

The State has a program that, except with respect to Christian Science sanatoria, meets the requirements of 42 CFR Part 431, Subpart N, for the licensing of nursing home administrators.

---

TN # 73-45

Supersedes

TN # \_\_\_\_\_

Approval Date 7/19/74

Effective Date 10/1/73

Revision: HCFA-PM- (MB)

State/Territory: North CarolinaCitation1927 (g)  
42 CFR 456.700

## 4.26 Drug Utilization Review Program

1927(g)(1)(A)

A.1. The Medicaid agency meets the requirements of Section 1927(g) of the Act for a drug use review (DUR) program for outpatient drug claims.

2. The DUR program assures that prescriptions for outpatient drugs are:

- Appropriate
- Medically necessary
- Are not likely to result in adverse medical results

1927(g)(1)(a)  
42 CFR 456.705(b) and  
456.709(b)

B. The DUR program is designed to educate physicians and pharmacists to identify and reduce the frequency of patterns of fraud, abuse, gross overuse, or inappropriate or medically unnecessary care among physicians, pharmacists, and patients or associated with specific drugs as well as:

- Potential and actual adverse drug reactions
- Therapeutic appropriateness
- over utilization and under utilization
- Appropriate use of generic products
- Therapeutic duplication
- Drug disease contraindications
- Drug-drug interactions
- Incorrect drug dosage or duration of drug treatment
- Drug-allergy -interactions
- Clinical abuse/misuse

1927(g)(1)(B)  
42 CFR 456.703  
(d)and(f)

C. The DUR program shall assess data use against predetermined standards whose source materials for their development are consistent with peer-reviewed medical literature which has been critically reviewed by unbiased independent experts and the following compendia:

- American Hospital Formulary Service Drug Information
- United States Pharmacopoeia-Drug Information
- American Medical Association Drug Evaluations

TN No. 93-08  
Supersedes  
TN No. 92-29Approval Date JUN-23 1993Effective Date 4-1-93

Revision: HCFA-PM- (MB)

State/Territory: North CarolinaCitation

- 1927(g)(1)(D)  
42 CFR 456.703(b)
- D. DUR is not required for drugs dispensed to residents of nursing facilities that are in compliance with drug regimen review procedures set forth in 42 CFR 483.60. The State has never-the-less chosen to include nursing home drugs in:
- Prospective DUR
  - Retrospective DUR
- 1927(g)(2)(A)  
42 CFR 456.705(b)
- E.1. The DUR program includes prospective review of drug therapy at the point of sale or point of distribution before each prescription is filled or delivered to the Medicaid recipient
- 1927(g)(2)(A)(i)  
42 CFR 456.705(b),  
(1)-(7)
2. Prospective DUR includes screening each prescription filled or delivered to an individual receiving benefits for potential drug therapy problems due to:
- Therapeutic duplication
  - Drug-disease contraindications
  - Drug-drug interactions
  - Drug-interactions with non-prescription or over-the-counter drugs
  - Incorrect drug dosage or duration of drug treatment
  - Drug allergy interactions
  - Clinical abuse/misuse
- 1927(g)(2)(A)(ii)  
42 CFR 456.705 (c)  
and (d)
3. Prospective DUR includes counseling for Medicaid recipients based on standards established by State law and maintenance of patient profiles.
- 1927(g)(2)(B)  
42 CFR 456.709(a)
- F.1. The DUR program includes retrospective DUR through its mechanized drug claims processing and information retrieval system or otherwise which undertakes ongoing periodic examination of claims data and other records to identify:
- Patterns of fraud and abuse
  - Gross overuse
  - Inappropriate or medically unnecessary care among physicians, pharmacists, Medicaid recipients, or associated with specific drugs or groups of drugs.

Revision: HCFA-PM- (MB)  
 State/Territory: North Carolina

Citation

- 927(g)(2)(C)  
 42 CFR 456.709(b)
- F-2. The DUR program assesses data on drug use against explicit predetermined standards including but not limited to monitoring for:
- Therapeutic appropriateness
  - Over utilization and under utilization
  - Appropriate use of generic products
  - Therapeutic duplication
  - Drug-disease contraindications
  - Drug-drug interactions
  - Incorrect drug dosage/duration of drug treatment
  - clinical abuse/misuse
- 1927(g)(2)(D)  
 42 CFR 456.711
3. The DUR program through its State DUR Board, using data provided by the Board, provides for active and ongoing educational outreach programs to educate practitioners on common drug therapy problems to improve prescribing and dispensing practices.
- 1927(g)(3)(A)  
 42 CFR 456.716(a)
- G.I. The DUR program has established a State DUR Board either:
- X   Directly, or  
       Under contract with a private organization
- 1927(g)(3)(B)  
 42 CFR 456.716  
 (A) AND (B)
2. The DUR Board membership includes health professionals (one-third licensed actively practicing pharmacists and one-third but no more than 51 percent licensed and actively practicing physicians) with knowledge and experience in one or more of the following:
- Clinically appropriate prescribing of covered outpatient drugs.
  - Clinically appropriate dispensing and monitoring of covered outpatient drugs.
  - Drug use review, evaluation and intervention.
  - Medical quality assurance.
- 927(g)(3)(c)  
 42 CFR 456.716(d)
3. The activities of the DUR Board include:
- Retrospective DUR,
  - Application of Standards as defined in section 1927(g)(2)(C), and
  - Ongoing interventions for physicians and pharmacists targeted toward therapy problems or individuals identified in the course of retrospective DUR.

TN No. 93-08  
 Supersedes  
 TN No. 92-29

Approval Date JUN 23 1993

Effective Date 4-1-93

Revision: HCFA-PM- (MB)

OMB No.

State/Territory: North CarolinaCitation1927(g)(3)(C)  
42 CFR 456.711  
(a)-(d)

- G.4 The interventions include in appropriate instances:
- Information dissemination
  - Written, oral, and electronic reminders
  - Face-to-Face discussions
  - Intensified monitoring/review of prescribers/dispensers

1927(g)(3)(D)  
42 CFR 456.712  
(A) and (B)

- H. The State assures that it will prepare and submit an annual report to the Secretary, which incorporates a report from the State DUR Board, and that the State will adhere to the plans, steps, procedures as described in the report

1927 (h) (1)  
42 CFR 456.722

- I.1. The State establishes, as its principal means of processing claims for covered outpatient drugs under this title, a point-of-sale electronic claims management system to perform on-line:

- real time eligibility verification
- claims data capture
- adjudication of claims
- assistance to pharmacists, etc. applying for and receiving payment.

1927(g)(2)(A)(i)  
42 CFR 456.705(b)

2. Prospective DUR is performed using an electronic point of sale drug claims processing system.

1927(j)(2)  
42 CFR 456.703(c)

- J. Hospitals which dispense covered outpatient drugs are exempted from the drug utilization review requirements of this section when facilities use drug formulary systems and bill the Medicaid program no more than the hospital's purchasing cost for such covered outpatient drugs.

\* U.S. G.P.O. :1993-342-239:80043

TN No. 93-08Supersede  
TN No. NEWApproval Date JUN 23 1993Effective Date 4-1-93

Revision: HCFA-AT-80-38(BPP)  
 May 22, 1980

State North Carolina

Citation  
 42 CFR 431.115(c)  
 AT-78-90  
 AT-79-74

4.27 Disclosure of Survey Information and  
 Provider or Contractor Evaluation

The Medicaid agency has established procedures for disclosing pertinent findings obtained from surveys and provider and contractor evaluations that meet all the requirements in 42 CER 431.1.15.

---

TN #79-34  
 Supersedes  
 TN #\_\_\_\_\_

Approval Date 12/17/79

Effective Date 10/18/79

Revision: HCFA-PK-93-1  
January 1993

(BPD)

State/Territory: North Carolina

Citation

4.28 Appeals Process

42 CFR 431.152;  
AT-79-18  
52 FR 22444;  
Secs. .  
L9 02 (a) (2 8) (D) I)  
ana 1919(e)(7) of  
the Act; P.L.  
100-203 (Sec. 4211(c)).

- (a) The Medicaid agency has established appeals procedures for NFs as specified in 42 CFR 431.153 and 431.154.
- (b) The State provides an appeals system that meets the requirements of 42 CFR 431 Subpart E, 42 CFR 483.12, and 42 CFR 483 Subpart E for residents who wish to appeal a notice of intent to transfer or discharge from a NF and for individuals adversely affected by the preadmission and annual resident review requirements of 42 CFR 483 Subpart C.

TN No. 94-30  
Supersede  
TN No. 88-18

Approval Date NOV 30 1994

Effective Date 7/1/94



Revision: HCFA-PM-99-3 (CMSO)  
June 1999

State: North Carolina

Citation

1902(a)(4)(C) of the  
Social Security Act  
P.L. 105-33

4.29 Conflict of Interest Provisions

The Medicaid agency meets the requirements of Section 1902 (a)(4)(C) of the Act concerning the Prohibition against acts, with respect to any activity under the plan that is prohibited by section 207 or 208 of title 18, United States Code.

1902(a)(4)(D) of the  
Social Security Act  
P. L. 105-33  
1932(d)(3)  
42 CFR 438.58

The Medicaid agency meets the requirements of 1902(a)(4)(D) of the Act concerning safeguards against conflicts of interest that are at least as stringent as the safeguards that apply under section 27 of the Office of Federal Procurement Policy Act (41 U.S.C. 423).

Revision: HCFA-PM-87-14 (BERC)  
OCTOBER 1987

OMB No.: 0938-0193

State/Territory: NORTH CAROLINA

<p><u>Citation</u> 42 CFR 1002.203 AT-79-54 48 FR 3742 51 FR 34772</p>	<p>4.30 <u>Exclusion of Providers and Suspension of Practitioners and Other Individuals</u>  (a) All requirements of 42 CFR Part 1002, Subpart B are met.</p>
--	---

— The agency, under the authority of State law, imposes broader sanctions.

---

TN No. 88-01  
Supersedes  
TN No. 87-5

Approval Date 2/3/88

Effective Date 1-1-88

HCFA ID: 101OP/0012P

Revision: HCFA-AT-87-14 (BERC)  
OCTOBER 1987

OMB No. 0938-0193  
4.30 Continued

State/Territory: NORTH CAROLINA

Citation

- (b) The Medicaid agency meets the requirements of-
- 1902(p) of the Act  
P.L. 100-93  
(secs. 7)
- (1) Section 1902(p) of the Act by  
excluding from participation-
- (A) At the State's discretion,  
any individual or entity for any reason  
for which the Secretary could exclude  
the individual or entity from  
participation in a program under title  
XVIII in accordance with sections 1128,  
1128A, or 1866(b)(2).
- 42 CFR 438.808
- (B) Any MCO (as defined in section 1903(m)  
of the Act) or an entity furnishing  
services under a waiver approved under  
section 1915(b)(1) of the Act, that-
- (i) Could be excluded under section  
1128(b)(8) relating to owners and  
managing employees who have been  
convicted of certain crimes or  
received other sanctions, or
- (ii) Has, directly or indirectly,  
substantial contractual  
relationship (as defined by the  
Secretary) with an individual or  
entity that is described in section  
1123(b)(8)(B) of the Act.
- 1932(d)(1)  
42 CFR 438.610
- (2) An MCO, PIHP, PAHP, or PCCM may  
not have prohibited affiliations with individuals  
(as defined in 42 CFR 438.610(b)) suspended, or  
otherwise excluded from participating in  
procurement activities under the Federal  
Acquisition Regulation or from participating in  
non-procurement activities under regulations  
issued under Executive Order No. 12549 or under  
guidelines implementing Executive Order No. 12549.  
If the State finds that an MCO, PCCM, PIHP, or  
PAHP is not in compliance, the State will comply  
with the requirements of 42 CFR 438.610(c).

TN No. 03-04  
Supersedes  
8/13/2003  
TN No. 88-01

Approval Date: NOV 18 2003

Effective Date

HCFA ID: 1010P/0012P

Revision: HCFA-AT-87-14 (BERC)  
OCTOBER 1987

OMB No.: 0938-0193  
4.30 Continued

State/Territory: NORTH CAROLINA

Citation

1902(a)(39) of the Act  
P.L. 100-93  
(see. 8(f))

(2) Section 1902(a)(39) of the Act by

(A) Excluding an individual or entity from participation for the period specified by the Secretary, when required by the Secretary to do so in accordance with sections 1128 or 1128A of the Act; and

(B) Providing that no payment will be made with respect to any item or service furnished by an individual or entity during this period

(c) The Medicaid agency meets the requirements of-

1902(a)(41)  
of the Act  
P.L. 96-272,  
(sec. 308(c))

(1) Section 1902(a)(41) of the Act

with respect to prompt notification to HCFA whenever a provider is terminated, suspended, sanctioned, or otherwise excluded from participating under this State plan; and

1902(a)(49)  
of the Act  
P.L. 100-93  
(sec. 5(a)(4))

(2) Section 1902(a)(49) of the Act

with respect to providing information and access to information regarding sanctions taken against health care practitioners and providers by State licensing authorities in accordance with section 1921 of the Act.

---

TN No. 88-01  
Supersedes  
TN No. \_\_\_\_\_

Approval Date 2/3/88

Effective Date 1-1-88

Revision: HCFA-PM-87-14 (BERC) OMB No.: 0938-0193  
OCTOBER 1987

State/Territory: NORTH CAROLINA

Citation

455.103  
44 FR 41644  
1902(a)(38)  
of the Act  
P.L. 100-93  
(sec. 8(f))

4.31 Disclosure of Information by- Providers  
and Fiscal agents

The Medicaid agency has established procedures for the disclosure of information by providers and fiscal agents as specified in 42 CFR 455.104 through 455.106 and sections 1128(b)(9) and 1902(a)(38) of the Act.

435.940  
through 435.960  
52 FR 5967

4.32 Income and Eligibility Verification  
System

- (a) The Medicaid agency has established a system for income and eligibility verification in accordance with the requirements of 42 CFR 435.940 through 435.960.
- (b) ATTACHMENT 4.32-A describes, in accordance with 42 CFR 435.948(a) (6), the information that will be requested in order to verify eligibility or the correct payment amount and the agencies and the State(s) from which that information will be requested.
- (c) The state has an eligibility determination system that provides for data matching through the Public Assistance Reporting Information System (PARIS), or any successor system, including matching with medical assistance programs operated by the States. The information that is requested will be exchanged with States and other entities legally entitled to verify title XIX applicants and individuals eligible for covered title XIX services consistent with applicable PARIS agreements.

TN No. 11-006  
Supersedes  
TN No. 88-01

Approval Date: 04-13-11

Effective Date 01/01/2011  
HCFA ID: 1010P/0012P

(BERC) OMB 110 0938-0193  
Revision: HCFA-PM  
OCTOBER 1987

State/Territory: NORTH CAROLINA

Citation  
1902(a)(48)  
of the Act,  
P.L. 99-570  
(Section 11005)  
P.L 100-93  
(sec. 5(a)(3))

4.33 Medicaid Eligibility Cards for Homeless  
Individuals

- (a) The Medicaid agency has a method for making cards evidencing eligibility for medical assistance available to an individual eligible under the State's approved plan who does not reside in a permanent dwelling or does not have a fixed home or mailing address.
- (c) ATTACHMENT 4.33-A specifies the method for issuance of Medicaid eligibility cards to homeless individuals.

TN No. 88-01  
Supersedes  
TN No. 87-5

Approval Date 2/3/88

Effective Date 1-1-88

HCFA ID:1010P/0012P

Revision: HCFA-PM-88-10 (BERC) OMB No.: 0938-0193  
 SEPTEMBER 1988  
 State/Territory: North Carolina

Citation  
 1137 of  
 the Act

P.L. 99-603  
 (sec. 121)

4.34 Systematic Alien Verification for Entitlements The State Medicaid agency has established procedures for the verification of alien status through the Immigration & Naturalization Service (INS) designated system, Systematic Alien Verification for Entitlements (SAVE). effective October 1, 1988.

— The State Medicaid agency has elected to participate in the option period of October 1, 1987 to, September 30, 1988 to verify alien status through the INS designated system (SAVE).

— The State Medicaid agency has received the following type(s) of waiver from participation in SAVE.

— Total waiver

— Alternative system

— Partial implementation

TN No. 88-18  
 Supersedes  
 TN No. New

Approval Date JAN 0 9 1989  
 Received 1-3-89

Effective Date 10/1/88  
 HCFA ID:1010P/0012P

Revision: HCFA-PM-95-4  
JUNE 1995

(HSQB)

State/Territory: North Carolina

Citation 4.35 Enforcement of Compliance for Nursing Facilities

42 CFR (a) Notification of Enforcement Remedies  
§488.402(f)

When taking an enforcement action against a non-State operated NF, the State provides notification in accordance with 42 CFR 488.402(f).

(i) The notice (except for civil money penalties and State monitoring) specifies the:

- (1) nature of noncompliance,
- (2) which remedy is imposed,
- (3) effective date of the remedy,
- (4) and right to appeal the determination leading to the remedy.

42 CFR  
§48a.434

(ii) The notice for civil money penalties is in writing and contains the information specified in 42 CFR 488.434.

42 CFR  
§488.402(f)(2)

(iii) Except for civil money penalties and State monitoring, notice is given at least 2 calendar days before the effective date of the enforcement remedy for immediate jeopardy situations and at least 15 calendar days before the effective date of the enforcement remedy when immediate jeopardy does not exist.

42 CFR  
§483.456(c)(d)

(iv) Notification of termination is given to the facility and to the public at least 2 calendar days before the remedy's effective date if the noncompliance constitutes immediate jeopardy and at least 15 calendar days before the remedy's effective date if the noncompliance does not constitute immediate jeopardy. The State must terminate the provider agreement of an NF in accordance with procedures in parts 431 and 442.

(b) Factors to be Considered in Selecting Remedies

42 CFR  
§488.488.404(b)(1)

(i) In determining the seriousness of deficiencies, the State considers the factors specified in 42 CFR 488.404(b)(1) & (2)

— The State considers additional factors. Attachment 4.35-A describes the State's other factors.

TN No. 95-12  
Supersedes  
TN No. New

Approval Date: 10-23-95

Effective Date: 7/1/95



Revision: HCFA-PM-95-4 (HSQB)  
JUNE 1995

State/Territory: North Carolina

Citation

c) Application of Remedies

- 42 CFR  
§488.410
- (i) If there is immediate jeopardy to resident health or safety, the State terminates the NF's provider agreement within 23 calendar days from the date of the last survey or immediately imposes temporary management to remove the threat within 23 days.
- 42 CFR  
§488.417(b)  
§1919(h)(2)(C)  
of the Act
- (ii) The State imposes the denial of payment (or its approved alternative) with respect to any individual admitted to an NF that has not come into substantial compliance within 3 months after the last day of the survey.
- 42 CFR  
§488.414  
§1919(h)(2)(D)  
of the Act.
- (iii) The State Imposes the denial of payment for new admissions remedy as specified in §488.417 (or its approved alternative) and a State monitor as specified at §488.422, when a facility has; been found to have provided substandard quality of care on the last three consecutive standard surveys.
- 42 CFR  
§488.408  
1919(h)(2)(A)  
of the Act.
- (iv) The State follows the criteria specified at 42 CFR §488.408(c)(2), §488.408(d)(2), and §488.408(e)(2), when it imposes remedies in place of or in addition to termination.
- 42 CFR  
§489.412(a)
- (v) When immediate jeopardy does not exist, the State terminates an NF's provider agreement no later than 6 months from the finding of noncompliance, if the conditions of 42 CFR 488.412(a) are not met.

(d) Available Remedies

- 42 CFR  
§488.406(b)  
§1919(h)(2)(A)  
of the Act.
- (i) The State has established the remedies defined in 42 CFR 488.406(b)
- |          |     |   |
|----------|-----|---|
| <u>X</u> | (1) | Termination   |
| <u>x</u> | (2) | Temporary Management  |
| <u>x</u> | (3) | Denial of Payment for New Admissions  |
| <u>X</u> | (4) | Civil Money Penalties   |
| <u>X</u> | (5) | Transfer of Residents;<br>Transfer of Residents with<br>Closure of Facility |
| <u>X</u> | (6) | State Monitoring  |

Attachments 4.35-3 through 4.35-G describe the criteria for applying the above remedies.

TN No. 95-12  
Supersedes  
TN No. New

Approval Date: 10-23-95

Effective Date: 7/1/95

Revision: HCFA-PM-95-4 (HSQB)  
JUNE 1995

State/Territory: North Carolina

Citation

42 CFR  
§488.406(b)The  
§1919(h)(2)(B)  
of the Act.

- (ii) \_\_\_ The State uses alternative remedies. State has established alternative remedies that the State will impose in place of a remedy specified in 42 CFR 488.406(b).
- \_\_\_ (1) Temporary Management
- \_\_\_ (2) Denial of Payment for New Admissions
- \_\_\_ (3) Civil Money Penalties
- \_\_\_ (4) Transfer of Residents; Transfer of Residents with closure of Facility
- \_\_\_ (5) State Monitoring.

Attachments 4.35-B through 4.35-G describe the alternative remedies and the criteria for applying them.

42 CFR  
§488.303(b)  
1910(h)(2)(F)  
of the Act.

- (e) \_\_\_ State Incentive Programs
- \_\_\_ (1) Public Recognition
- \_\_\_ (2) Incentive Payments

Revision: HCFA-PM-91- 4 (BPD)  
AUGUST 1991

OMB No.: 0938-

State/Territory: North Carolina

Citation

4.36 Required Coordination Between the  
Medicaid and WIC Programs

1902(a)(11)(C)  
and 1902(a)(53)  
of the Act

The Medicaid agency provides for the coordination between the Medicaid program and the Special Supplemental Food Program for Women, Infants, and Children (WIC) and provides timely notice and referral to WIC in accordance with section 1902(a)(53)of the Act.

---

TN No. 92-01

Supersedes

Approval Date 10-21-92

Effective Date 1/1/92

TN No. NEW

HCFA ID: 7982E

Revision: HCFA-PM-91- 10 (BPD)  
DECEMBER 1, 991

State/Territory: North Carolina

Citation

42 CFR 483.75; 42  
CFR 483 Subpart D;  
Secs. 1902(a)(28),  
1919(e)(1) and (2),  
and 1919(f)(2),  
P.L. 100-203 (Sec.  
4211(a)(3)); P.L.  
101-239 (Secs.  
6901(b)(3) and (4));  
P.L. 101-508  
(Sec. 4801(a)).

- 4.38 Nurse Aide Training and Competency  
Evaluation for Nursing Facilities
- (a) The State assures that the requirements of 42 CFR 483.150(a), which relate to individuals deemed to meet the nurse aide training and competency evaluation requirements, are met.
- X (b) The State waives the competency evaluation requirements for individuals who meet the requirements of 42 CFR 483.150(b)(1).
- X (c) The State deems individuals who meet the requirements of 42 CFR 483.150(b)(2) to have met the nurse aide training and competency evaluation requirements.
- = (d) The State specifies any nurse aide training and competency evaluation programs it approves as meeting the requirements of 42 CFR 483.152 and competency evaluation programs it approves as meeting the requirements of 42 CFR 483.154.
- No (e) The State offers a nurse aide training and competency evaluation program that meets the requirements of 42 CFR 483.152.
- No (f) The State offers a nurse aide competency evaluation program that meets the requirements of 42 CFR 483.154.

TN No. 92-08  
Supersedes  
TN NO. NEW

Approval Date Mar 27 1992 Effective Date 01-01-92

Revision: HCFA-PM-91- 10  
DECEMBER 1991

(BPD)

State/Territory: North Carolina

Citation

42 CFR 483-75; 42  
CFR 483 Subpart D ;  
Secs. 1902(a)(28),  
1919(e)(1) and (2),  
and 1919(f)(2),  
P.L. 100-203 (Sec-  
4211(a)(3)); P.L.  
101-239 (Secs.  
6901(b)(3) and  
(4)); P.L. 101-508  
(Sec. 4801(a)).

- (g) If the State does not choose to offer a nurse aide training and competency evaluation program or nurse aide competency evaluation program, the State reviews all nurse aide training and competency evaluation programs and competency evaluation programs upon request.
- (h) The State survey agency determines, during the course of all surveys, whether the requirements of 483.75(e) are met.
- (i) Before approving a nurse aide training and competency evaluation program, the State determines whether the requirements of 42 CFR 483-152 are met.
- (j) Before approving a nurse aide competency evaluation program, the state determines whether the requirements of 42 CFR 483-154 are met.
- (k) For program reviews other than the initial review, the State visits the entity providing the program.
- (l) The State does not approve a nurse aide training and competency evaluation program or competency evaluation program offered by or in certain facilities as described in 42 CFR 483.151(b)(2) and (3).

TN No. 92-08  
Supersedes  
TN No. NEW

Approval Date MAR 27 1992 Effective Date 01-01-92

Revision: HCFA-PH-91-10  
DECEMBER 1991

(BPD)

State/Territory: North Carolina

Citation

42 CFR 483.7S; 42  
CFR 483 Subpart D;  
Secs. 1902 (a) (28),  
1919 (e) (1) and (2)  
and 1919(f)(2),  
P.L. 100-203 (Sec.  
4211(a)(3)); P.L.  
101-239 (Secs.  
6901(b) (3) and  
(4)); P.L. 101-508  
(Sec. 4801 (a))

- (m) The State, within 90 days of receiving a request for approval of a nurse aide training and competency evaluation program or competency evaluation program, either advises the requestor whether or not the program has been approved or requests additional information from the requestor.
- (n) The State does not grant approval of a nurse aide training and competency evaluation program for a period longer than 2 years.
- (o) The State reviews programs when notified of substantive changes (e.g., extensive curriculum modification).
- (p) The State withdraws approval from nurse aide training and competency evaluation program and competency evaluation programs when the program is described in 42 CFR 483.151(b)(2) or (3).
- x (q) The State withdraws approval of nurse aide training and competency evaluation programs that cease to meet the requirements of 42 CFR 463.152 and competency-evaluation programs that cease to meet the requirements of 42 CFR 483.154.
- (r) The State withdraws approval of nurse aide training and competency evaluation program and competency evaluation programs that do not permit unannounced visits by the State.

---

TN No. 92-08

Supersedes

Approval Date MAR 27 1992Effective Date 01-01-92TN No. NEW

Revision: HCFA-PH-91-10  
DECEMBER 1991

(BPD)

State/Territory: North Carolina

Citation

42 CFR 463.75; 42  
CFR 483 Subpart D;  
Secs. 1902(a)(28),  
1919(e)(1) and (2),  
and 1919(f)(2),  
P.L. 100-203 (Sec.  
4211(a)(3)); P-L  
101-239 (Secs.  
6901(b)(3) and  
(4)); P.L. 101-508  
(Sec. 4801 (a) )

- (s) When the State withdraws approval from a nurse aide training and competency evaluation program or competency evaluation program, the State notifies the program in writing, indicating the reasons for withdrawal of approval.
- (t) The State permits students who have started a training and competency evaluation program from which approval is withdrawn to finish the program.
- (u) The State provides for the reimbursement of costs incurred in completing a nurse aide training and competency evaluation program or competency evaluation program for nurse aides who become employed by or who obtain an offer of employment from a facility within 12 months of completing such program.
- (v) The State provides advance notice that a record of successful completion of competency evaluation will be included in the State's nurse aide registry.
- (w) Competency evaluation programs are administered by the State or by a State Approved entity which is neither a skilled nursing facility participating in Medicare nor a nursing facility participating in Medicaid.
- x (x) The State permits proctoring of the competency evaluation in accordance with 42 CFR 483.154(d).
- (y) The State has a standard for successful completion of competency evaluation programs.

---

TN No. 92 08

Supersedes

Approval Date Mar 27 1992

Effective Date 01-01-92

TN No. NEW

Revision: HCFA-PH-91-10  
DECEMBER 1991

(BPD)

State/Territory: North Carolina

---

<p><u>Citation</u> 42 CFR 483-75; 42 CFR 483 Subpart D; Secs. 1902(a)(28), 1919(e)(1) and (2), and 1919(f)(2), P.L. 100-203 (Sec. 4211(a)(3)); P.L. 101-239 (Secs. 6901(b)(3) and (4)); P.L. 101-508 (Sec. 4801(a)).</p>	<p>(z) The State includes a record of successful completion of a competency evaluation within 30 days of the date an individual is found competent.</p>
<p><u>No</u></p>	<p>(aa) The State imposes a maximum upon the number of times an individual may take a competency evaluation program (any maximum imposed is not-less than 3).</p>
<p><u>No</u></p>	<p>(bb) The State maintains a nurse aide registry that meets the requirements in 42 CFR 483.156.</p>
<p><u>x</u></p>	<p>(cc) The State includes home health aides on the registry.</p>
<p><u>No</u></p>	<p>(dd) The State contracts the operation of the registry to a non State entity.</p>
<p><u>x</u></p>	<p>(ee) <u>ATTACHMENT 4.38</u> contains the state's description of registry information to be disclosed in addition to that required in 42 CFR 483.156 (c)(1)(iii) and (iv).</p>
<p><u>x</u></p>	<p>(ff) <u>ATTACHMENT 4.38-A</u> contains the State's description of information included on the registry in addition to the information required by 42 CFR 483.156(c).</p>

---

TN NO. 92-08

Supersedes

Approval Date MAR 27 1992

Effective Date 01-01-92

TN NO. NEW



Revision: HCFA-PM-93-1 (BPO)  
January 1993

State/Territory: North Carolina

Citation

Secs.

1902(a)(28)(D)(j)  
and 1919(e)(7) of  
the Act;

P.L. 100-203

(Sec. 4211(c));

P.L. 101-508

(Sec. 4801(b)).

4.39 Preadmission screening and Annual  
Resident Review in Nursing Facilities

- (a) The Medicaid agency has in effect a written agreement with the State mental health and mental retardation authorities that meet the requirements of 42 (CFR) 431.621(c).
- (b) The State operates a preadmission and annual resident review program that meets the requirements of 42 CFR 483.100-138.
- (c) The State does not claim as "medical assistance under the State Plan" the cost of services to individuals who should receive preadmission screening or annual resident review until such individuals are screened or reviewed.
- (d) With the exception of NF services furnished to certain NF residents defined in 42 CFR 483.118(c)(1), the State does not claim as "medical assistance under the State plan" the cost of NF services to individuals who are found not to require NF services.
- X (e) ATTACHMENT 4.39 specifies the State's definition of specialized services.

TN No. 94-30

Supersedes

TN No. \_\_\_\_\_

Approval Date NOV 30 1994

Effective Date 7/1/94

Revision: HcFA-PM-3-1  
January 1993

(BPD)

State/Territory: North Carolina

4.39 (Continued)

- (f) Except for residents identified in 42 CFR 483.118(c)(1), the State mental health or mental retardation authority makes categorical determinations that individuals with certain mental conditions or levels of severity of mental illness would normally require specialized services of such an intensity that a specialized services program could not be delivered by the State in most, if not all, NFs and that a more appropriate placement should be utilized.
- (g) The State describes any categorical determinations it applies in ATTACHMENT 4.39-A.

Revision: HCFA-PM-92-3 (HSQB)  
APRIL 1992

State Territory North Carolina

<u>Citation</u>	4.40	<u>Survey &amp; Certification Process</u>
Sections 1919(g)(1) thru (2) and 1919(g)(4) thru (5) of the Act P.L. 100-203 Sec. 4212(a))		(a) The State assures that the requirements or 1919(g)(1)(A) through (C) and section 1919(q)(2) (A) through (E)(i.11) of the Act which relate to the survey and (certification of non-State owned facilities based an the requirements of section 1919(b), (c) and (d) of the Act, are met.
1919(g)(1) (B)(C) of the Act		(b) The State conducts periodic education programs for staff and residents(and their representatives). <u>Attachment 4.40-A</u> describes the survey and certification educational program.
1919(g)(1) (C) of the Act		(c) The state provides for a process receipt and timely review and investigation of allegations of neglect and abuse and misappropriation of resident property by a nurse aide of a resident in a nursing facility or by another individual used by the facility. <u>Attachment 4.40-B</u> describes the State's process.
1919(g)(1) (C) of the Act		(d) The State agency responsible for surveys and certification of nursing facilities or an agency delegated by the State survey agency conducts the process for the receipt and timely review and investigation of allegations of neglect and abuse and misappropriation of resident property. if not the State survey agency, what agency?
1919(g)(1) (C) of the Act		(e) The State assures that a nurse aide, found to have neglected or abused a resident or misappropriated resident property in a facility, is notified of the finding. The name and finding is placed on the nurse aide registry.
1919(g)(1) (C) of the Act		(f) The State notifies the appropriate licensure authority of any licensed individual found to have neglected or abused a resident or misappropriated resident property in a facility.

TN No. 92-25  
Supersedes  
92  
TN No. New

Approval Date AUG 27 1992

Effective Date 04-01-

HCFA ID: \_\_\_\_\_

Revision: HCFA-PM-92-3  
APRIL 1992

(HSQB)

OMB NO:

State/Territory: North Carolina

- 1919(g)(2)  
for a  
(A)(i) of  
the Act
- (g) The State has procedures, as provided section 1919(g) (2) (A) (i) , for the scheduling and conduct of standard surveys to assure that the State has taken all reasonable steps to avoid giving notice through the scheduling procedures and the conduct of the surveys themselves. Attachment 4.40-C describes the State, procedures
- 1919(g)(2)  
have  
(A) (ii) of  
case-  
the Act  
of
- (h) The State assures that each facility shall a standard survey which includes (for a mix stratified sample of residents) a survey the quality of care furnished, as measured by indicators of medical, nursing and rehabilitative care, dietary and nutritional services, activities and social participation, and sanitation, infection control, and the physical environment, written plans of care and audit of resident's assessments, and a review of compliance with resident's rights not later than 15 months after the date of the previous standard survey.
- 1919(g)(2)  
average  
(A)(ii)(I)  
nursing  
of the Act
- (i) The State assures that the Statewide interval between standard surveys of facilities does not exceed 12 months.
- 1919(g)(2)  
or  
(A) (iii) (ii)  
of the Act
- (j) The state may conduct a special standard special abbreviated standard survey within 2 months of any change of ownership, administration, management, or director of nursing of the nursing facility to determine whether the change has resulted in any decline in the quality of care furnished in the facility.
- 1919(g)(2)  
immediately  
(B) of the  
weeks  
Act
- (k) The State conducts extended surveys or, if not practicable, not later than 2 following a completed standard survey in a nursing facility which is found to have provided substandard care or in any other facility at the Secretary's or State's discretion.
- 1919(g)(2)  
(C) of the  
survey  
Act
- (l) The state conducts standard and extended surveys based upon a protocol, i.e., forms, methods, procedures and guidelines developed by HCFA, using individuals in the survey team who meet minimum qualifications established by the Secretary.

---

TN No. 92-25  
Supersedes  
TN No. New

Approval Date **AUG 27 1992**

Effective Date 04-01-92

HCFA ID: \_\_\_\_\_

Revision: HCFA-PM-92- 3  
APRIL 1992

(HSQB)

OMB No:

State/Territory: North Carolina

- 1919(g)(2)  
(D) of the  
Act (m) The State provides for programs to measure and reduce inconsistency in the application of survey results among surveyors. Attachment 4.40-D describes the State's programs.
- 1919(g)(2)  
(E)(i) of  
the Act (n) The State uses a multidisciplinary team of professionals including a registered professional nurse.
- 1919(g)(2)  
(E)(ii) of  
the Act (o) The State assures that member of a survey team do not serve (or have not serve within the previous two years) an a member of the staff or consultant to the nursing facility or has no personal or familial financial interest in the facility being surveyed.
- 1919(g)(2)  
(E)(iii) of  
the Act (P) The State assures that no individual shall serve as a member of any survey team unless the individual has successfully completed a training and test program in survey and certification techniques approved by the Secretary.
- 1919(g)(4)  
of the Act (q) The State maintains procedures and adequate staff to investigate complaints of violations of requirements by nursing facilities and onsite monitoring. Attachment 4-40-E describes the State's complaint procedures.
- 1919(g)(5)  
(A) of the  
Act (r) The State makes available to the public information respecting surveys and certification of nursing facilities including statements of deficiencies, plans of correction, copies of cost reports, statements of ownership and the information disclosed under section 1126 of the Act.
- 1919(g)(5)  
(B)(3) of the  
Act (s) The State notifies the State long-term care ombudsman of the State's finding of non-compliance with any of the requirements of subsection (b), (c), and (d) or of any adverse actions taken against a nursing facility.
- 1919(g)(5)  
(C) of the  
attending  
Act (t) If the State finds substandard quality of care in a facility, the State notifies the physician of each resident with respect to which such finding is made and the nursing facility administrator licensing board.
- 1919(g)(5)  
and  
(D) of the  
Act (u) The State provides the state Medicaid fraud abuse agency access to all information concerning survey and certification actions.

TN No. 92-25  
Supersedes  
TN No. New

Approval Date AUG 27 1992Effective Date 04-01-92

HCFA ID: \_\_\_\_\_

Revision: HCFA-PM-92-. 2 (HSQB)  
MARCH 1992

State/Territory: North Carolina

Citation                    4.41 Resident Assessment for Nursing Facilities

Sections                    (a)    The State specifies the instrument to be  
1919(b)(3)                    used by nursing facilities for  
and 1919                    conducting a comprehensive, accurate,  
(e)(5) of                    standardized, reproducible assessment of  
the Act                    each resident's functional capacity as  
                                  required in §1919 (b)(3)(A) of the Act.

1919(e)(5)                    (b)    The State is using:  
(A) of the                      x      the resident assessment instrument  
Act                                    designated by the Health Care  
    Financing Administration (see  
    Transmittal 241 of the State  
    Operations Manual) (§1919(e)(5)  
    (A)]; or

1919(e)(5)                              a resident assessment instrument  
(B) of the                    that the Secretary has approved as  
Act                                    being consistent with the minimum  
    data set of core elements, common  
    definitions, and utilization  
    guidelines as specified by the  
    Secretary (see Section 4470 of the  
    State Medicaid manual for the  
    Secretary's approval criteria)  
    [§1919 (e)(5)(B) ] .

## STATE PLAN UNDER TITLE XIX OF THE SOCIAL SECURITY ACT

State/Territory: North Carolina

Citation  
1902(a)(68) of  
the Act,  
P.L. 109-171

4.42 Employee Education about False Claims Recoveries  
(a) The Medicaid agency meets the requirements regarding establishment of policies and procedures for the education of employees of entities covered by section 1902(a)(68) of the Social Security Act (the Act) regarding false claims recoveries and methodologies for oversight of entities' compliance with these requirements.

## 1 Definitions.

(A) An “entity” includes a governmental agency, organization, unit, corporation, partnership, or other business arrangement (including any Medicaid managed care organization, irrespective of the form of business structure or arrangement by which it exists), whether for-profit or not-for-profit, which receives or makes payments, under a State Plan approved under title XIX or under any waiver of such plan, totaling at least \$5,000,000 annually.

If an entity furnishes items or services at more than a single location or under more than one contractual or other payment arrangement, the provisions of section 1902(a)(68) apply if the aggregate payments to that entity meet the \$5,000,000 annual threshold. This applies whether the entity submits claims for payments using one or more provider identification or tax identification numbers.

A governmental component providing Medicaid health care items or services for which Medicaid payments are made would qualify as an “entity”(e.g., a state mental



STATE PLAN UNDER TITLE XIX OF THE SOCIAL SECURITY ACT

State/Territory: North Carolina

health facility or school district providing school-based health services.) A government agency which merely administers the Medicaid program, in whole or part (e.g., managing the claims processing system or determining beneficiary eligibility), is not, for these purposes, considered to be an entity.

An entity will have met the \$5,000,000 annual threshold as of January 1, 2007, if it received or made payments in that amount in Federal fiscal year 2006. Future determinations regarding an entity's responsibility stemming from the requirements of section 1902(a)(68) will be made by January 1 of each subsequent year, based upon the amount of payments an entity either received or made under the State Plan during the preceding Federal fiscal year.

(B) An "employee" includes any officer or employee of the entity.

(C) A "contractor" or "agent" includes any contractor, subcontractor, agent, or other person which or who, on behalf of the entity, furnishes or otherwise authorizes the furnishing of, Medicaid health care items or services, performs billing or coding functions, or is involved in the monitoring of health care provided by the entity.

- (2) The entity must establish and disseminate written policies which must also be adopted by its contractors or agents. Written policies may be on paper or in electronic form, but must be readily available to all employees, contractors, or agents. The entity need not create an employee handbook if none already exists.

STATE PLAN UNDER TITLE XIX OF THE SOCIAL SECURITY ACT

State/Territory: North Carolina

- (3) An entity shall establish written policies for all employees (including management), and of any contractor or agent of the entity, that include detailed information about the False Claims Act and the other provisions named in section 1902(a)(68)(A). The entity shall include in those written policies detailed information about the entity's policies and procedures for detecting and preventing waste, fraud, and abuse. The entity shall also include in any employee handbook a specific discussion of the laws described in the written policies, the rights of employees to be protected as whistleblowers and a specific discussion of the entity's policies and procedures for detecting and preventing fraud, waste, and abuse.
- (4) The requirements of this law should be incorporated into each State's provider enrollment agreements.
- (5) The State will implement this State Plan amendment on January 1, 2007.
- (b) ATTACHMENT 4.42-A describes, in accordance with section 1902(a)(68) of the Act, the methodology of compliance oversight and the frequency with which the State will re-assess compliance on an ongoing basis.

---

TN. No.: 07-005

Supersedes

TN No.: New

Approval Date: 06/27/07

Effective Date: 01/01/07

State Plan Under Title XIX of the Social Security Act

State Territory: North Carolina

<u>Citation</u> 42 USCS 1396a(69) P.L. 109-171 (section 6034)	4.43	<u>Cooperation with Medicaid Integrity Program Efforts</u> The Medicaid agency assures it complies with such requirements determined by the Secretary to be necessary for carrying out the Medicaid Integrity Program established pursuant to 42 USCS 1396u-6.
---	------	---

TN. No. 08-008  
Supersedes  
TN. No. NEW

Approval Date: 08/15/08

Effective Date: 07/01/08

STATE PLAN UNDER TITLE XIX OF THE SOCIAL SECURITY ACT

State/Territory: North Carolina

Citation

4.5 Medicaid Recovery Audit Contractor Program

Section 1902  
(a)(42)(B)(i)  
Social Security Act

The State has established a program under which it will contract with one or more recovery audit contractors (RACs) for the purpose of identifying underpayments and overpayments of Medicaid claims under the State Plan and under any waiver of the State Plan.

The State is seeking an exception to establishing such program for the following reasons:

Section 1902  
(a)(42)(B)(ii)(I)  
of the Act

The State/Medicaid agency has contracts of the type(s) listed in section 1902(a)(42)(B)(ii)(I) of the Act. All contracts meet the requirements of the statute. RACs are consistent with the statute.

Place a check mark to provide assurance of the following:

The State will make payments to the RAC(s) only from amounts recovered.

The State will make payments to the RAC(s) on a contingent basis for collecting overpayments.

Section 1902  
(a)(42)(B)(ii)  
(II)(aa)of the Act

The following payment methodology shall be used to determine State payments to Medicaid RACs for identification and recovery of overpayments (e.g., the percentage of the contingency fee):

The State attests that the contingency fee rate paid to the Medicaid RAC will not exceed the highest rate paid to Medicare RACs, as published in the Federal Register.

The State attests that the contingency fee rate paid to the Medicaid RAC will exceed the highest rate paid to Medicare RACs, as published in the Federal Register. The State will only submit for FFP up to the amount equivalent to that published rate.

TN. No. 10-037

Supersedes

Approval Date: 02-15-11 Effective Date: 12/10/2010

TN. No. NEW

## STATE PLAN UNDER TITLE XIX OF THE SOCIAL SECURITY ACT

State/Territory: North Carolina

---

	_____	The contingency fee rate paid to the Medicaid RAC will exceed the highest rate paid to Medicare RACs, as published in the Federal Register. The State will submit a justification for that rate and will submit for FFP for the full amount of the contingency fee.
Section 1902 (a)(42)(B)(ii)(II)(bb) of the Act	<u>X</u>	The following payment methodology shall be used to determine State payments to Medicaid RACs for the identification of underpayments (e.g., amount of flat fee, the percentage of the contingency fee): \$30.00 flat fee per overpayment identified.
Section 1902 (a)(42)(B)(ii)(III) of the Act	<u>X</u>	The State has an adequate appeal process in place for entities to appeal any adverse determination made by the Medicaid RAC(s).
Section 1902 (a)(42)(B)(ii)(IV)(aa) of the Act	<u>X</u>	The State assures that the amounts expended by the State to carry out the program will be amounts expended as necessary for the proper and efficient administration of the State Plan or a waiver of the plan.
Section 1902 (a)(42)(B)(ii)(IV)(bb) of the Act	<u>X</u>	The State assures that the recovered amounts will be subject to a State's quarterly expenditure estimates and funding of the State's share.
Section 1902 (a)(42)(B)(ii)(IV)(cc) of the Act	<u>X</u>	Efforts of the Medicaid RAC(s) will be coordinated with other contractors or entities performing audits of entities receiving payments under the State plan or wavier in the State, and/or State and Federal law enforcement entities and the CMS Medicaid Integrity Program.

TN. No. 10-037

Supersedes \_\_\_\_\_ Approval Date: 02-15-11 Effective Date: 12/10/2010

TN. No. NEW

STATE PLAN UNDER TITLE XIX OF THE SOCIAL SECURITY ACT

State/Territory: North Carolina

---

4.44 Medicaid Prohibition on Payments to Institutions or Entities Located Outside the United States.

Citation

Section 1902(a)(80) of the Social Security Act, P.L. 111-148 (Section 6505)

X The state shall not provide any payments for items or services provided under the State plan or under a waiver to any financial institution or entity located outside the United States.

TN. No. 11-009

Supersedes

TN. No. NEW

Approval Date \_\_\_\_\_

Eff. Date 06/01/2011

HCFA ID:

Revision: HCFA-AT-80-38(BPP)  
May 22, 1980

State North Carolina

SECTION 5 PERSONNEL ADMINISTRATION

Citation                    5.1 Standards of Personnel Administration

42 CFR 432.10(a)

AT-78-90

AT-79-23

AT-80-34

(a) The Medicaid agency has established and will maintain methods of personnel administration in conformity with standards prescribed by the U.S. Civil Service Commission in accordance with Section 208 of the Intergovernmental Personnel Act of 1970 and the regulations on Administration of the Standards for a Merit System of Personnel Administration, 5 CFR Part 900, Subpart F. All requirements of 42 CFR 432.10 are met.

x The plan is locally administered and State-supervised. The requirements of 42 CFR 432.10 with respect to local agency administration are met.

(b) Affirmative Action Plan

The Medicaid agency has in effect an affirmative action plan for equal employment opportunity that includes specific action steps and timetables and meets all other requirements of 5 CFR Part 900, Subpart F.

TN #77-17  
Supersedes  
TN # \_\_\_\_\_

Approval Date 10/6/77

Effective Date 9/30/77

Revision: HCFA-AT-80-38(BPP)  
May 22, 1980

State North Carolina

---

5.2 [Reserved]

---

TN # \_\_\_\_\_  
Supersedes \_\_\_\_\_ Approval Date \_\_\_\_\_ Effective Date \_\_\_\_\_  
TN # \_\_\_\_\_



Revision: HCFA-AT-80-38(BPP)  
May 22, 1980

State North Carolina

Citation  
42 CFR Part 432,  
Subpart B  
AT-78-90

5.3 Training Programs; Subprofessional and  
Volunteer Programs

The Medicaid agency meets the requirements of 42 CFR Part 432, Subpart B, with respect to a training program for agency personnel and the training and use of subprofessional staff and volunteers.

---

TN #78-2  
Supersedes  
TN # \_\_\_\_\_

Approval Date 3/7/78

Effective Date 2/27/78

Revision: HCFA-AT-80-38(BPP)  
May 22, 1980

State North Carolina

SECTION 6 FINANCIAL ADMINISTRATION

Citation  
42 CFR 433.32  
AT-79-29

6.1 Fiscal Policies and Accountability

The Medicaid agency and, where applicable, local agencies administering the plan, maintains an accounting system and supporting fiscal records adequate to assure that claims for Federal funds are in accord with applicable Federal requirements. The requirements of 42 CFR 433.32 are met.

---

TN # 76-20  
Supersedes  
TN # \_\_\_\_\_

Approval Date 6/24/76

Effective Date 6/30/76

Revision: HCFA-AT-82-10 (BPP)

State North Carolina

Citation  
42 CFR 433.34  
47 FR 17490

6.2 Cost Allocation

There is an approved cost allocation plan on file with the Department in accordance with the requirements contained in 45 CFR Part 95, Subpart E.

---

TN # 82-10  
Supersedes  
TN # 76-20

Approval Date 8/23/82 Effective Date 5/24/82

Revision: HCFA-AT-80-38(BPP)  
May 22, 1980

State North Carolina

Citation  
42 CFR 433.33  
AT-79-29  
AT-80-34

6.3 State Financial Participation

- (a) State funds are used in both assistance and administration.

       State funds are used to pay all of non-Federal share of total expenditures under the plan.

  x   There is local participation. State funds are used to pay not less than 40 percent of the non-Federal share of the total expenditures under the plan. There is a method of apportioning Federal and State funds among the political subdivisions of the State on an equalization or other basis which assures that lack of adequate funds from local sources will not result in lowering the amount, duration, scope or quality of care and services or level of administration under the plan in any part of the State.

- (b) State and Federal funds are apportioned among the political subdivisions of the State on a basis consistent with equitable treatment of individuals in similar circumstances throughout the State.

TN #76-20  
Supersedes  
TN #       

Approval Date 6/24/76

Effective Date 6/30/76

Revision: HCFA-PM-91- 4 (BPD) OMB No. 0938-  
AUGUST 1991

State/Territory: North Carolina

SECTION 7 - GENERAL PROVISIONS

Citation                      7.1 Plan Amendments

42 CFR 430.12(c)                      The plan will be amended whenever  
necessary to reflect new or revised Federal  
statutes or regulations or material change in  
State law, organization, policy or State agency  
operation.

---

TN No. 92-01  
Supersedes                      Approval Date 10-21-92                      Effective Date 1/1/92  
TN No. 78-11

Revision: HCFA-PM-91- 4 (BPD)  
AUGUST 1991

HCFA ID: 7982E  
OMB No. 0938

State/Territory: North Carolina

Citation                      7.2 Nondiscrimination

45 CFR Parts  
80 and 84

In accordance with title VI of the Civil Rights Act of 1964 (42 U.S.C. 2000d et. seq.), Section 504 of the Rehabilitation Act of 1973 (29 U.S.C. 70b), and the regulations at 45 CFR Parts 80 and 84, the Medicaid agency assures that no individual shall be subject to discrimination under this plan on the grounds of race, color, national origin, or handicap.

The Medicaid agency has methods of administration to assure that each program or activity for which it receives Federal financial assistance will be operated in accordance with title VI regulations. These methods for title VI are described in ATTACHMENT 7.2-A

TN No. 92-01  
Supersedes  
TN No. 79-9

Approval Date 10-21-92

Effective Date 1/1/92

HCFA ID: 7982E

Revision: HCFA-PM-91-4 (BPD)  
AUGUST 1991

OMB No. 0938-

State/Territory: \_\_\_\_\_

Citation            7.3 Maintenance of AFDC Efforts

1902 (c) of the Act    \_\_\_\_\_ The State agency has in effect under its approved AFDC plan payment levels that are equal to or more than the AFDC payment levels in effect on May 1, 1988.

TN #00-03  
Supersedes  
TN #78-11

Approval Date Aug 02 2000    Effective Date 04/01/00

HCFA ID: 7982E

Revision: HCFA-PH-91-4 (BPD)  
August 1991

OMB No. 0938

State/Territory: North Carolina

Citation 7.4 State Governor's Review

42 CFR 430.12(b)

The Medicaid agency will provide opportunity for the Office of the Governor to review State plan amendments, long-range program planning projections, and other periodic reports thereon, excluding periodic statistical, budget and fiscal reports. Any comments made will be transmitted to the Health Care Financing Administration with such documents.

- Not applicable. The Governor--
- Does not wish to review any plan material.
- Wishes to review only the plan materials specified in the enclosed document.
- Review is not required in accordance with 42 CFR 430.12(b).

I hereby certify that I am authorized to submit this plan on behalf of

The Department of Health and Human Services  
(Designated Single State Agency)

Date: March 24, 2000

  
(Signature)

H. David Bruton, M.D., Secretary  
(Title)

TN No. 00-03  
Supersedes  
TN No. 94-22

Approval Date Aug 02 2000

Eff. Date 04/01/00



## STATE PLAN UNDER TITLE XIX OF THE SOCIAL SECURITY ACT

State/Territory: North Carolina4.46 **Provider Screening and Enrollment**

This document outlines how the Medicaid agency establishes procedures under which screening is conducted with respect to providers of medical or other items or services and suppliers under Medicare, Medicaid, and CHIP, including requirements to comply with the process of screening providers and suppliers and imposing temporary enrollment moratoria for the Medicaid program as established by the Secretary under 1866(j)(2) and (7) of the Act.

Beginning with 2012, all participating Medicaid providers will be screened upon initial application, including applications for a new practice location, and any applications received in response to a request for re-enrollment. Screening will also be performed for a provider who is revalidated for enrollment. The required screening measures vary according to the provider's categorical risk level of "limited," "moderate" or "high."

The Medicaid agency will impose an application fee on each institutional provider "with respect to which screening is conducted," whenever the required screening (whether upon initial enrollment, reactivation, or reenrollment) occurs and these fees will be used to offset the cost of conducting the required screening.

The Medicaid agency will include the disclosure requirements as specified in 42 CFR 455.104, 455.105, and 455.106 in revalidation efforts.

The Medicaid agency will confirm the identity and determine the exclusion status of providers and any person with an ownership or controlling interest or who is an agent or managing employee of the provider through routine checks of Federal databases. The Medicaid agency will check the Social Security Administration's Death Master File, the National Plan and Providers Enumeration System, the List of Excluded Individuals/Entities (LEIE), the Excluded Parties List System (EPLS), and any other databases as the Secretary may prescribe. States must consult these databases to confirm the identity of providers seeking enrollment and/or reenrollment in Medicaid programs or CHIP.

The Medicaid agency will determine which NPI number should be applied to the claim for payment if providers order or refer services for Medicaid or CHIP beneficiaries that are permitted under State law to order and/or refer services for Medicaid or CHIP beneficiaries but who do not have NPIs and who are not authorized to enroll as Medicaid or CHIP providers.

The Medicaid agency will comply with any temporary moratorium imposed by the Secretary unless the State determines that the imposition of such a moratorium would adversely impact beneficiaries' access to care.

TN. No.: 12-004  
Supersedes  
TN. No.: NEW

Approval Date: 06-26-12Eff. Date: 10/01/2012

State/Territory: NORTH CAROLINA

4.46 Provider Screening and Enrollment

Citation

1902(a)(77)  
1902(a)(39)  
1902(kk);  
P.L. 111-148 and  
P.L. 111-152

The State Medicaid agency gives the following assurances:

Citation  
SubpartE

**PROVIDER SCREENING**

X  Assures tha the State Medicaid agency complies with the process for screening providers under section 1902(a)(39), 19029(a)(77) and 1902 (kk) of the Act. Implementation date is October 1, 2012.

42 CFR 455.410

**ENROLLMENT AND SCREENING OF PROVIDERS**

X  Assures enrolled providers will be screened in accordance with 42 CFR 455.400 et. seq.

X  Assures that the State Mediciad agency requires all ordering or referring physicians or other professionals to be enrolled under the State plan or under a waiver of the Plan as a participating provider.

42 CFR 455.412

**VERIFICATION OF PROVIDER LICENSES**

X  Assures that the State Mediciad agency has a method for verifying providers licensed by a State and that such providers licenses have not expired or have no current limitations.

42 CFR 455.414

**REVALIDATION OF ENROLLMENT**

X  Assures that providers will be revalidated regardless of provider type at least every 5 years.

42 CFR 455.416

**TERMINATION OR DENIAL OF ENROLLMENT**

X  Assures that the State Medicaid agency will comply with section 1902(a)(39) of the Act and with the requirements outlined in 42 CFR 455.416 for all terminations or denials of provider enrollment.

42 CFR 455.420

**REACTIVATION OF PROVIDER ENROLLMENT**

X  Assures that any reactivation of a provider will include re-screening and payment aof application fees as required by 42 CFR 455.460. Implementation date is October 1, 2012.

TN. No. 12-004  
Supersedes  
TN. No. NEW

Approval Date: 06-26-12

Eff.Date: 10/01/2012

## STATE PLAN UNDER TITLE XIX OF THE SOCIAL SECURITY ACT

State/Territory: NORTH CAROLINA**4.46 Provider Screening and Enrollment**

- 42 CFR 455.422 APPEAL RIGHTS  
X Assures that all terminated providers and providers denied enrollment as a result of the requirements of 42 CFR 455.416 will have appeal rights available under procedures established by State law or regulation.
- 42 CFR 455.432 SITE VISITS  
X Assures that pre-enrollment and post-enrollment site visits of providers who are in "moderate" or "high" risk categories will occur.  
**Implementation Date October 1, 2012**
- 42 CFR 455.434 CRIMINAL BACKGROUND CHECKS  
X Assures that providers, as a condition of enrollment, will be required to consent to criminal background checks including fingerprints, if required to do so under State law, or by the level of screening based on risk of fraud, waste or abuse for that category of provider.
- 42 CFR 455.436 FEDERAL DATABASE CHECKS  
X Assures that the State Medicaid agency will perform Federal database checks on all providers or any person with an ownership or controlling interest or who is an agent or managing employee of the provider.
- 42 CFR 455.440 NATIONAL PROVIDER IDENTIFIER  
X Assures that the State Medicaid agency requires the National Provider Identifier of any ordering or referring physician or other professional to be specified on any claim for payment that is based on an order or referral of the physician or other professional.
- 42 CFR 455.450 SCREENING LEVELS FOR MEDICAID PROVIDERS  
X Assures that the State Medicaid agency complies with 1902(a)(77) and 1902(kk) of the Act and with the requirements outlined in 42 CFR 455.450 for screening levels based upon the categorical risk level determined for a provider.  
**Implementation Date October 1, 2012**
- 42 CFR 455.460 APPLICATION FEE  
X Assures that the State Medicaid agency complies with the requirements for collection of the application fee set forth in section 1866(j)(2)(C) of the Act and 42 CFR 455.460.  
**Implementation Date October 1, 2012**
- 42 CFR 455.470 TEMPORARY MORTATORIUM ON ENROLLMENT OF NEW PROVIDERS OR SUPPLIERS  
X Assures that the State Medicaid agency complies with any temporary moratorium on the enrollment of new providers or provider types imposed by the Secretary under section 1966(j)(7) and 1902(kk)(4) of the Act, subject to any determination by the State and written notice to the Secretary that such a temporary moratorium would not adversely impact beneficiaries' access to medical assistance.

TN. No.: 12-004  
 Supersedes  
 TN. No.: NEW

Approval Date: 06-26-12Eff. Date: 10/01/2012

STATE PLAN UNDER TITLE XIX OF THE SOCIAL SECURITY ACT  
MEDICAL ASSISTANCE PROGRAM

State of North Carolina

ATTORNEY GENERAL'S CERTIFICATION

---

I certify that:

Department of Health and Human Services

is the single State agency responsible for:

\_\_\_ administering the plan.

The legal authority under which the agency administers  
the plan on a Statewide basis is

---

(Statutory citation)

X supervising the administration of the plan by local political subdivisions.

The legal authority under which the agency supervises  
the administration of the plan on a Statewide basis is contained in

General Statutes 108A-25, 108A-54, 108A-54, 108A-56

(Statutory citation)

The agency's legal authority to make rules and regulations  
that are binding on the political subdivisions administering  
the plan is

General Statutes 108A-25 (b); 108A-54; 108A-70.5

(Statutory citation)

March 17, 2000  
DATE

Gayl Manthei

Gayl Manthei  
Special Deputy Attorney General  
NC Department of Justice

---

TN No. 00-03

Approval Date Aug 02 2000

Eff. Date 04/01/00

Supersedes

TN No. 73-45

STATE PLAN UNDER TITLE XIX OF THE SOCIAL SECURITY ACT  
Medical Assistance  
State: North Carolina

---

Waivers of the Single State Agency Requirement Granted Under the Intergovernmental  
Cooperation Act of 1968

- a. Waiver was granted on: 12-27-12.
- b. The organizational arrangement authorized, the nature and extent of responsibility for program administration delegated to: Office of Administrative Hearings (OAH) (name of agency)
- c. The resources and/or services of such agency to be utilized in administration of the plan are described below:

The Office of Administrative Hearings will make final agency decisions in contested Medicaid beneficiary and provider appeals cases as defined in paragraphs (d)(1) and (d)(2) below.

- d. The methods for coordinating responsibilities among the several agencies involved in administration of the plan under the alternate organizational arrangement are as follows:

The parties to this waiver acknowledge that the Division of Medical Assistance(DMA) delegates the authority to make final decisions regarding beneficiary and provider appeals cases as defined in paragraphs (d)(1) and (d)(2) below to the North Carolina Office of Administrative Hearings (OAH).

As a condition precedent for the State of North Carolina to receive federal financial participation for the functions authorized by this waiver of the single state agency requirement found at 42 C.F.R. § 431.10(e), the North Carolina Office of Administrative Hearings (“OAH”) must acknowledge and agree in writing that it will act as a neutral and impartial decision-maker on behalf of the North Carolina single state Medicaid agency in adjudicating contested Medicaid cases and that it will comply with all applicable federal and state laws, rules and regulations governing the Medicaid program.

In addition, OAH acknowledges and agrees that, except as allowed by law, enrolled Medicaid providers have no property or liberty right in initial or continued participation or enrollment in the North Carolina State Medicaid program.

OAH acknowledges and also agrees that the issue to be determined at final hearings conducted in accordance with this waiver is whether the single state Medicaid agency or one of its contractors or agents exceeded its authority or jurisdiction, acted erroneously, failed to use proper procedure, acted arbitrarily or capriciously, and/or failed to act as required by law or rule; that it will conduct *de novo* reviews in beneficiary.

STATE PLAN UNDER TITLE XIX OF THE SOCIAL SECURITY ACT  
Medical Assistance  
State: North Carolina

=====

cases as set forth below; that it will cooperate with any and all federal or state audits, monitoring, or oversight necessary to substantiate that OAH expenditures are valid and reasonable; that it will assist DMA in tracking and reporting of Medicaid appeal decisions as required by law; and that it will comply with each of the following conditions of this waiver:

1. “Contested Medicaid beneficiary cases” are those in which a Medicaid beneficiary of the single state Medicaid agency or one of its contractors or agents denies, reduces, terminates or suspends (or alleges such a decision was not acted upon with reasonable promptness), a Medicaid-reimbursable service. In all contested Medicaid beneficiary cases, OAH shall dismiss appeals when the conditions described in 42 CFR §431.223 are present, as set forth in N.C.G.S. §108A-70.9B(b)(4).
2. In all contested cases in which an enrolled Medicaid provider, or provider applicant, is challenging any decision of the single state Medicaid agency which directly or indirectly affected the provider or applicant substantially in their person, property, or employment as described in N.C.G.S. §§ 150B-2(6) and 150B-23 (“contested Medicaid provider cases”), OAH shall agree to dismiss all appeals: (a) that are filed outside of the timeline set forth in N.C.G.S. § 150B-23(f); (b) where the petitioner fails to timely serve the single state Medicaid agency; and (c) where the petitioner fails to pay the filing fee. Further, OAH shall agree to dismiss or impose another sanction as provided by law, all appeals where either party fails to file a Prehearing Statement or respond to discovery prior to the hearing, or where either party fails to appear at a scheduled hearing without good cause.
3. Except where agreed to by the parties or for other good cause, OAH agrees to schedule, hear and issue decisions in contested Medicaid beneficiary cases within the time period set forth in 42 C.F.R. § 431.244(f) and N.C.G.S. § 108A-70.9B(b)(1).
4. OAH shall schedule, hear and issue decisions in contested Medicaid provider cases within 180 days of the date the appeal is filed with OAH, except that hearings in cases where OAH has issued a temporary restraining order (“TRO”), stay or injunction shall be expedited as soon as practicable. The time for the appeal process may be extended in the event of delays caused or requested by the single state Medicaid agency.
5. OAH shall only issue TROs, stays or injunctions to maintain the status quo in contested beneficiary and provider Medicaid cases when the petitioner meets the requirements contained in Rule 65 of the North Carolina Rules of Civil Procedure. Any TRO so issued shall be in effect for no longer than allowed by law and shall not be continued except as provided in Rule 65. In contested Medicaid

Supersedes:  
TN. NEW

STATE PLAN UNDER TITLE XIX OF THE SOCIAL SECURITY ACT  
Medical Assistance  
State: North Carolina

---

=

beneficiary cases, OAH shall issue TROs, stays or injunctions which require the single state Medicaid agency or a Local Management Entity operating a Prepaid Inpatient Health Plan in accordance with 42 CFR Part 438 (LME/PIHP) to continue an authorization for Medicaid-reimbursable service(s), or to authorize service(s) at any particular level or frequency, during the pendency of an appeal to the extent required to meet the requirements of 42 CFR 431.230.

DMA and OAH shall allow all parties' witnesses to appear and testify by telephone at hearings, including but not limited to any expert witnesses, unless good cause is shown to require in person appearance by specific witnesses.

6. When a continuance is necessary, OAH shall only grant requests filed by either party for good cause shown, and shall ensure that hearings are not unreasonably delayed.
7. In contested Medicaid cases, OAH shall issue decisions that are based on the evidence introduced before the record is deemed closed by the Administrative Law Judge.
8. To the extent allowed under Rule 32 of the North Carolina Rules of Civil Procedure, OAH may consider deposition testimony in addition to other allowable testimony as evidence at the hearing on the merits. Affidavits and deposition testimony may be permitted for use as evidence in hearings on motions for preliminary injunctive relief as allowed by law.
9. In contested Medicaid beneficiary cases, OAH shall issue decisions that are based on the evidence introduced before the record is deemed closed by the Administrative Law Judge and the applicable provision(s) of federal or state laws, rules and regulations supporting the decision in accordance with 42 CFR § 431.244 and N.C.G.S. § 108A-70.9B(f).
10. In all contested Medicaid provider cases, OAH may allow both sides to prepare and file proposed decisions within thirty (30) days of the date of the hearing, unless either party requests a transcript of the hearing, in which case proposed decisions shall be due within thirty (30) days of the date the transcript is prepared and served on the parties.
11. Subject to the provisions of Article 3 of Chapter 150B of the North Carolina General Statutes and N.C.G.S. § 108C, OAH shall timely issue decisions in contested Medicaid provider cases which include Findings of Fact and Conclusions of Law and are based on the evidence presented before the record is deemed closed by the Administrative Law Judge. If applicable to an issue in the case, such



Supersedes:  
TN. NEW

STATE PLAN UNDER TITLE XIX OF THE SOCIAL SECURITY ACT

Medical Assistance

State: North Carolina

=====

decisions shall be based on the North Carolina State Plan for Medical Assistance and any amendments thereto or waivers therefrom which have been approved by CMS, properly promulgated DMA medical coverage policies, and any applicable federal and state laws, court decisions, rules, and regulations.

12. Subject to applicable law, OAH shall require in the absence of good cause that all discovery be completed at least thirty (30) days prior to the scheduled hearing date, shall comply with the North Carolina Rules of Civil Procedure in contested Medicaid provider cases, and may limit discovery in such cases to provide for the prompt disposition of the contested case and to ensure that the burden or expense of the proposed discovery does not outweigh its likely benefit, considering the needs of the case, the amount in controversy, the parties' resources, the importance of the issues at stake in the action, and the importance of the discovery in resolving the issues.
13. DMA retains oversight of the State Plan and will establish a process to monitor the entire appeals process, including the quality and accuracy of the final decisions made by OAH.

TN. NEW

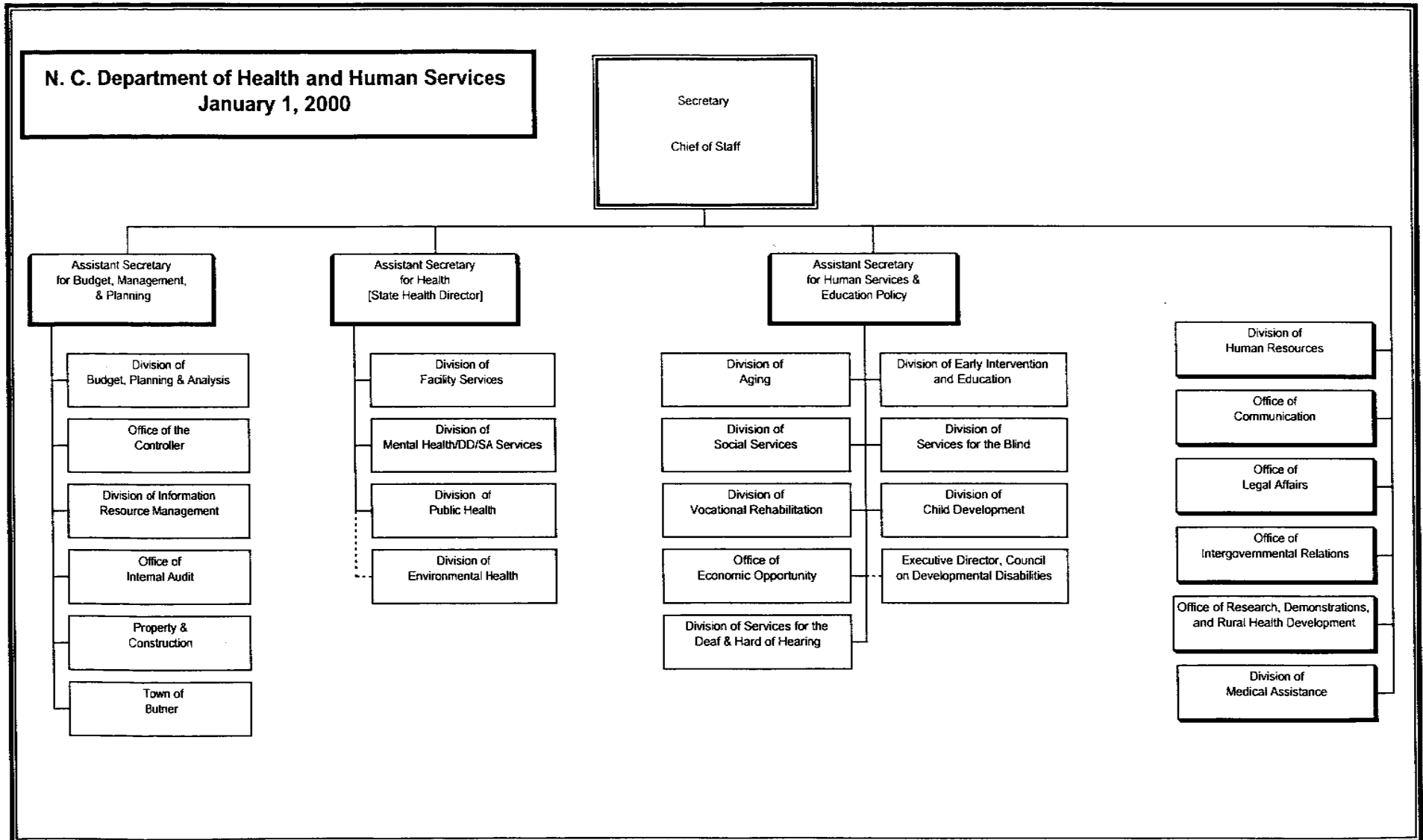

ORGANIZATION AND FUNCTIONS STATE DEPARTMENT OF HEALTH AND HUMAN SERVICES

The services of the Department of Health and Human Services are provided by many programs which are organized within several divisions and agencies.

Division: Division of Budget, Planning and Analysis  
Division of Information Resource Management  
Division of Facility Services  
Division of Mental Health/DD/SA Services  
Division of Public Health  
Division of Environmental Health  
Division of Aging  
Division of Social Services  
Division of Vocational Rehabilitation  
Division of Services for the Deaf and Hard of Hearing  
Division of Early Intervention and Education  
Division of Services for the Blind  
Division of Child Development  
Division of Human Resources  
Division of Medical Assistance

Agencies: Office of the Controller  
Office of Internal Audit  
Office of Economic Opportunity  
Office of Communication  
Office of Legal Affairs  
Office of Intergovernmental Relations  
Office of Research, Demonstrations, and Rural Health Development  
Office of Citizen Services

## **OFFICE OF THE SECRETARY**

This office, created by the Executive Organization Act of 1973, is a part of the Executive Branch of State Government. The Secretary, appointed by the Governor, serves as the principal officer of the Department and is responsible for the necessary management, development of policy, establishment of standards general health, social services and rehabilitation. Divisions and agencies within the Office of the Secretary are the Division of Human Resources, Communications Office, Legal Office of Citizen Services, Office of Intergovernmental Relations, Office of Research and Rural Health Development, and Division of Medical Assistance.

### **DIVISION OF AGING**

The Division of Aging promotes successful aging for North Carolina's older population and their families, advancing their social, health, and economic well-being. Working closely with Area Agencies on Aging and local service providers, the Division supports the independence and dignity of impaired older persons through such home and community services as in-home aide care, congregate and home-delivered meals, transportation, adult day care, housing and home improvement, and respite for family caregivers.

The Division promotes the rights of residents of nursing homes and adult care homes through its Ombudsman Program, and uses Senior Centers as local resources for information and access to a wide range of services and programs. The Division is also committed to helping younger generations prepare to enjoy their later years. Work of the Division is informed by the views of senior advocates.

## DIVISION OF SERVICES FOR THE BLIND

The Division of Services for the Blind provides treatment, rehabilitation, education and independent living alternatives for blind and visually impaired residents of North Carolina. Through vocational rehabilitation, the division helps people find and keep jobs. The division also promotes the prevention of blindness through educational programs.

The Governor Morehead School, the state's residential school for the blind, operates under the division. Located in Raleigh, the school serves children from birth to age 21. The school's programs include a preschool for children from birth to age five, an academic program for youth ages five to 21, and an alternative program for youth ages five to 21 who have other disabilities in addition to blindness. An outreach program is also available to children attending public school.

## DIVISION OF CHILD DEVELOPMENT

The Division of Child Development protects the well-being of children while they are away from their parents by licensing, monitoring, and regulating child day care. More than 190,000 of North Carolina's children spend their days in regulated day care centers and homes. Children attending day care full-time beginning at age two months will spend nearly 10,000 hours in day care by the time they enter kindergarten.

Passage of Governor Hunt's Smart Start program in 1993 brought more improvements to the quality of child care for our state's youngest children, resulting in more individualized attention through smaller child/staff ratios for children under two.

The Child Development Division provides technical assistance to help child care programs accommodate children with special needs, assists home child care providers on meeting safety standards, and helps communities establish resource and referral agencies to help families find the child care they need. The division also helps low-income families pay for child care, enabling parents to go to work.

## OFFICE OF CITIZEN SERVICES

One-stop shopping in the Department of Health and Human Services is available through the Office of Citizen Services, which allows citizens to travel through the maze of the human service delivery system by answering questions, cutting through red tape and serving as a clearinghouse for information relating to the services to which the people of the state are entitled.

The Office of Citizen Services' toll-free Information and Referral Service/CARE-LINE is staffed with specialists who offer information and referral on human services within the Department of Health and Human Services and non-profits across the state. The office also handles complaints and inquiries related to department services through an Ombudsman Program. A bilingual specialist is available for Spanish-speaking callers. Office hours are Monday through Friday, 8 a.m.-5 p.m., except holidays.

In North Carolina, call 1-800-662-7030 (TTY/Voice/Spanish)

or 919-733-4261 (Voice)

or 919-733-4851 (TTY)



## DIVISION OF SERVICES FOR THE DEAF AND HARD OF HEARING

The state's 600,000 deaf and hard of hearing citizens can find the assistance and information they need from the Division of Services for the Deaf and Hard of Hearing. The division provides a broad range of services for children and adults, their families and the professionals who serve them. More than 770 children attend the N.C. Schools for the Deaf, and regional resource centers help families through the first difficult years of dealing with hearing loss. The division also provides interpreter services, advocacy, access to technology and coordination of human services for the deaf and hard of hearing.

## OFFICE OF ECONOMIC OPPORTUNITY

The Office of Economic Opportunity helps families to achieve economic independence with incomes above the federal poverty level. Families get help in finding a job or housing or any number of services that lead to independence. The office also gives shelter to an average of 2,000 homeless individuals and families per day, helping them get shelter, food, health care, and child care. The homeless can also get psychological and substance abuse counseling.

OEO channels funds to community-based, private non-profit agencies in the form of Community Services Block Grants (CSBGs), Community Action Partnership grants, and Emergency Shelter Grants Program.

The federal-funded Community Services Block Grant Program and the state-funded Community Action Partnership Grants, both enable local communities to address the causes and conditions of poverty, helping people become self-sufficient, gain employment, and find temporary and long-term housing. Emergency Shelter Grants help communities serve homeless individuals and families.

The 36 Community Action Agencies and the other private, non-profit agencies that receive grants through OEO, generate, on average, \$10 for every \$1 provided by the Office.

## DIVISION OF FACILITY SERVICES

The Division of Facility Services inspects, certifies, registers and licenses hospitals, nursing homes, adult care homes, mental health facilities, home care programs, and other health facilities. It determines the need for many such health facilities and services across the state and develops a plan to meet that need.

The division reviews health care facility designs and construction for safety and other concerns. It also oversees the effectiveness of the state's emergency medical services (EMS) system, issues permits for all ambulances in the state and certifies all local EMS personnel.

Other responsibilities include inspection and compliance enforcement and construction approval for local jails. The division also regulates charitable solicitations and bingo.

## DIVISION OF INFORMATION RESOURCE MANAGEMENT

The Division of Information Resource Management (DIRM) supports the Department of Health and Human Services' business and client record keeping needs. The division also provides technical services to the department and its related agencies, assuring access to department-maintained records for more than 14,000 local computer workstations across the state. In addition, DIRM processes and mails more than 17 million client documents each year.

## DIVISION OF MEDICAL ASSISTANCE

The Division of Medical Assistance is chiefly responsible for administering the federal Medicaid Program. The division also manages the Community Alternatives program, which helps the elderly and disabled remain in their homes by providing needed health and personal care services. The Baby Love program helps improve women's access to early prenatal care and preventive health care for low birth weight infants. Carolina Access connects people with primary care doctors who manage their patient care needs.

Health Check is an outreach program aimed at improving the quality of health care among low-income children. The program guarantees eligible children regular comprehensive health exams that include necessary immunizations, screenings and follow-up care.

## DIVISION OF MENTAL HEALTH, DEVELOPMENTAL DISABILITIES, AND SUBSTANCE ABUSE

North Carolinians and their families suffering from mental illness, struggling with a drug or alcohol addiction or coping with a developmental disability receive help and support from the Division of Mental Health, Developmental Disabilities and Substance Abuse.

The Division operates four regional psychiatric hospitals for those who need in-patient psychiatric services, and oversees a network of mental health programs in communities across the state. The division also responds to the special needs of children with serious emotional and behavioral disorders through three regional educational institutions. It operates a special care center for the elderly with serious medical and mental problems.

The division provides residential services at five regional mental retardation centers which provide a wide range of services to people with severe and profound mental retardation and other related disabilities. The division oversees residential and outpatient treatment at three alcohol and drug abuse treatment centers.

## DIVISION OF PUBLIC HEALTH

The Division of Public Health works to protect, promote, and preserve the health of North Carolinians through ethical, compassionate, and evidence-based public health practice. The division's wide range of programs and services are aimed toward protecting and improving the health of the people who live and work in North Carolina. Public health programs reach out to help build healthy families and communities, promote healthful living, lower the risk of disease and untimely death, and reduce the consequences of disease. The Division of Public Health also gathers and analyzes statewide health data and statistics needed for making sound public health decisions and policies.

The division works with other DHHS divisions, state agencies and local health departments and in partnership with public and private groups to ensure a healthy North Carolina.

#### OFFICE OF RURAL HEALTH AND RESOURCE DEVELOPMENT

The N.C. Office of Rural Health and Resource Development, founded in 1973 as the Office of Rural Health Services, provides technical assistance to small hospitals and community health centers in rural and medically under-served communities. The office also recruits health care providers to work in rural and medically under-served communities and provides grants for community health centers.

#### DIVISION OF SOCIAL SERVICES

The Division of Social Services provides immediate economic and social support to individuals and families. Its principal mission is to strengthen families and to help people get jobs and move off welfare.

Work First is Governor Jim Hunt's welfare reform effort, emphasizing work and personal responsibility. Work First sets strict time limits on benefits and tough sanctions for those who refuse to participate. It helps welfare parents become wage earners through job training and help pay for child care. Its goal is to streamline and simplify the welfare system, cutting red tape.

The division supports North Carolina families in numerous other ways:

Child support enforcement ensures children receive financial support from absent parents. Foster care services link children to nurturing private homes, group homes, or child-caring institutions.

Adoption services help place children with permanent, caring families. Protective services identify youngsters who are at risk for abuse or neglect and provides help to ensure their safety and well being.

Adolescent parenting programs work to delay a second pregnancy among teenagers and has effectively cut the rate of second pregnancies in half.

Social services offices operate in every county. Local offices are operated by the individual counties under the supervision of the state division.

#### DIVISION OF VOCATIONAL REHABILITATION

The goal of the Vocational Rehabilitation Program is employment. Vocational rehabilitation counselors work with business and community agencies to help them prepare their work

sites to accommodate employees who have physical or mental disabilities. The division also provides services that encourage and reinforce independent living for the disabled, through two main components: the Vocational Rehabilitation Program and the Independent Living Services Program.

Rehabilitation counselors in vocational rehabilitation offices across the state are available to assist people with disabilities with individualized plans to meet their unique needs. Counselors can provide vocational evaluations, job training, guidance and counseling. They help disabled people make the transition from rehabilitation to employment and educate them about the kinds of technology available that could increase independence.

DEPARTMENT OF HEALTH & HUMAN SERVICES  
 DIVISION OF MEDICAL ASSISTANCE

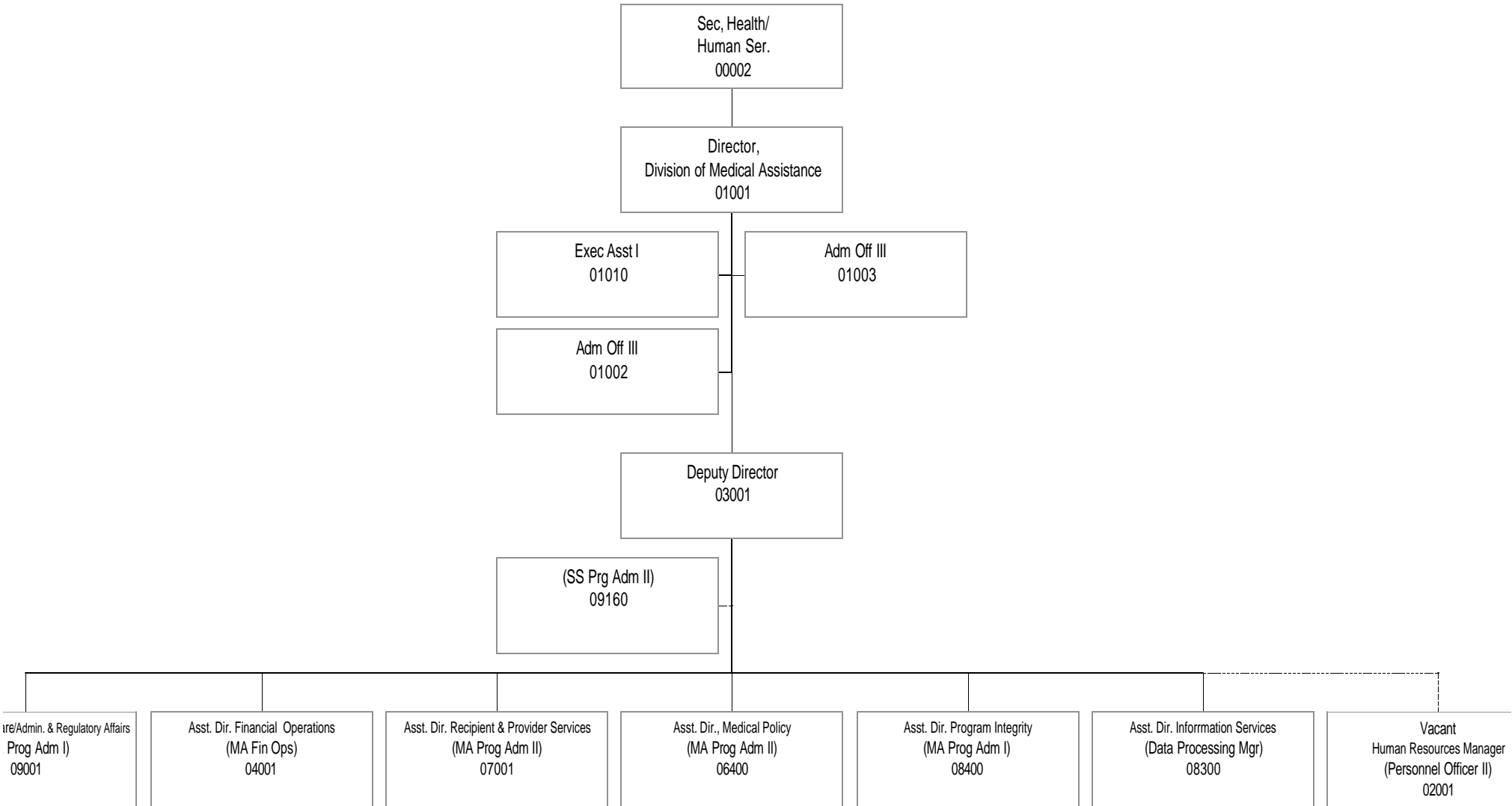

N No. 00-03

Approval Date 8/2/00

Eff. Date 4/01/00

supersedes

N No. 84-10

MANAGED CARE & ADMINISTRATIVE  
& REGULATORY AFFAIRS

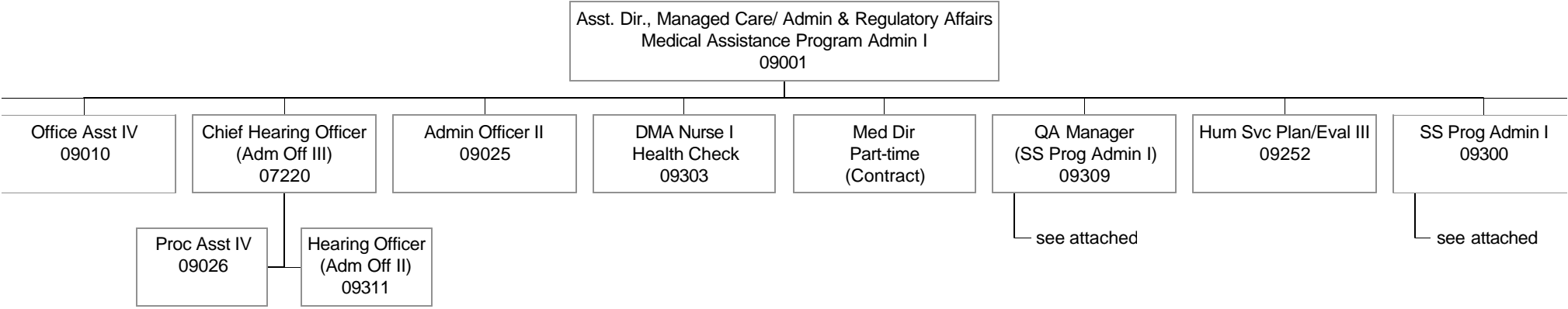



MANAGED CARE, ADMINISTRATIVE  
& REGULATORY AFFAIRS

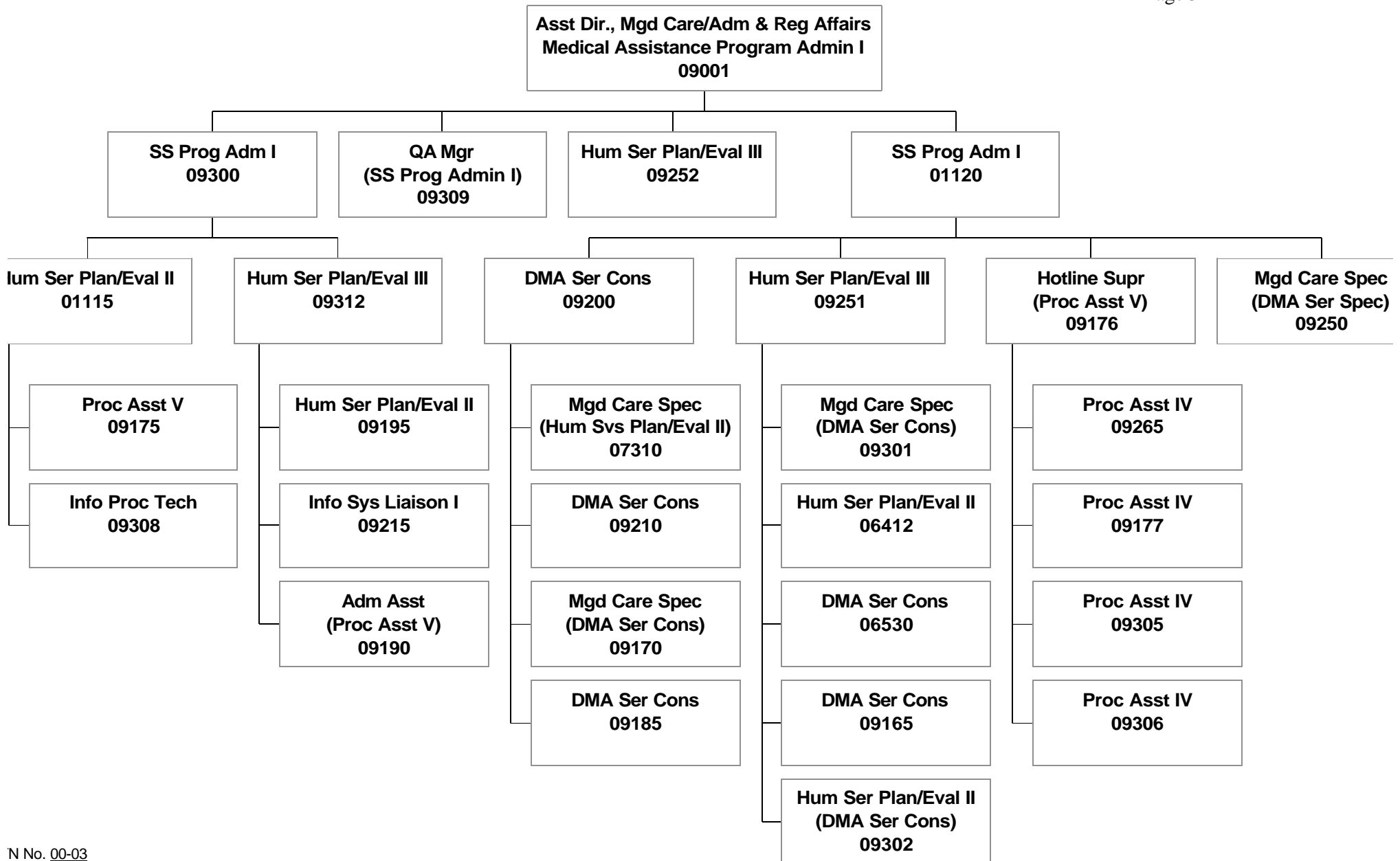

# FINANCIAL OPERATIONS

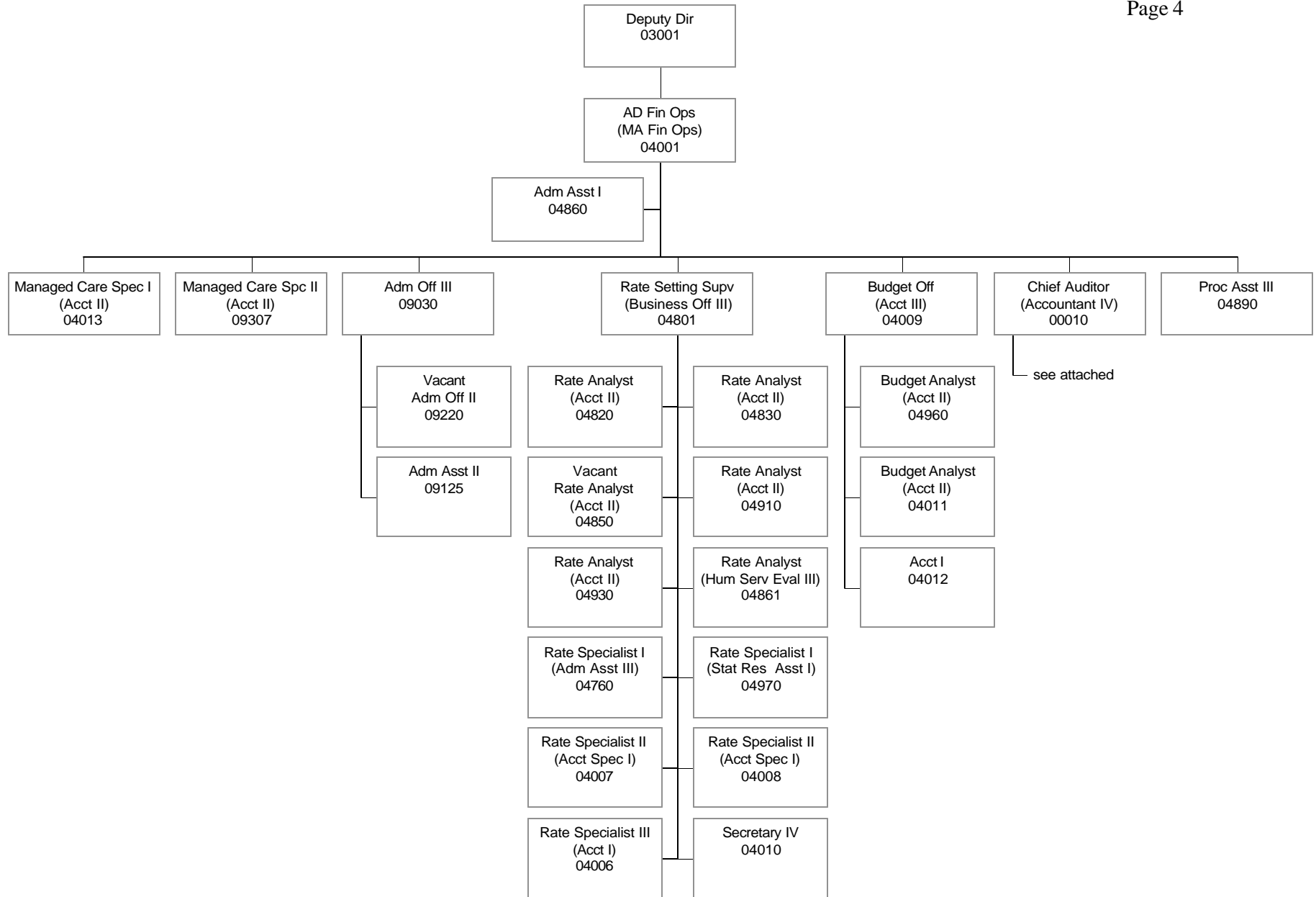

**FINANCIAL OPERATIONS:  
AUDIT**

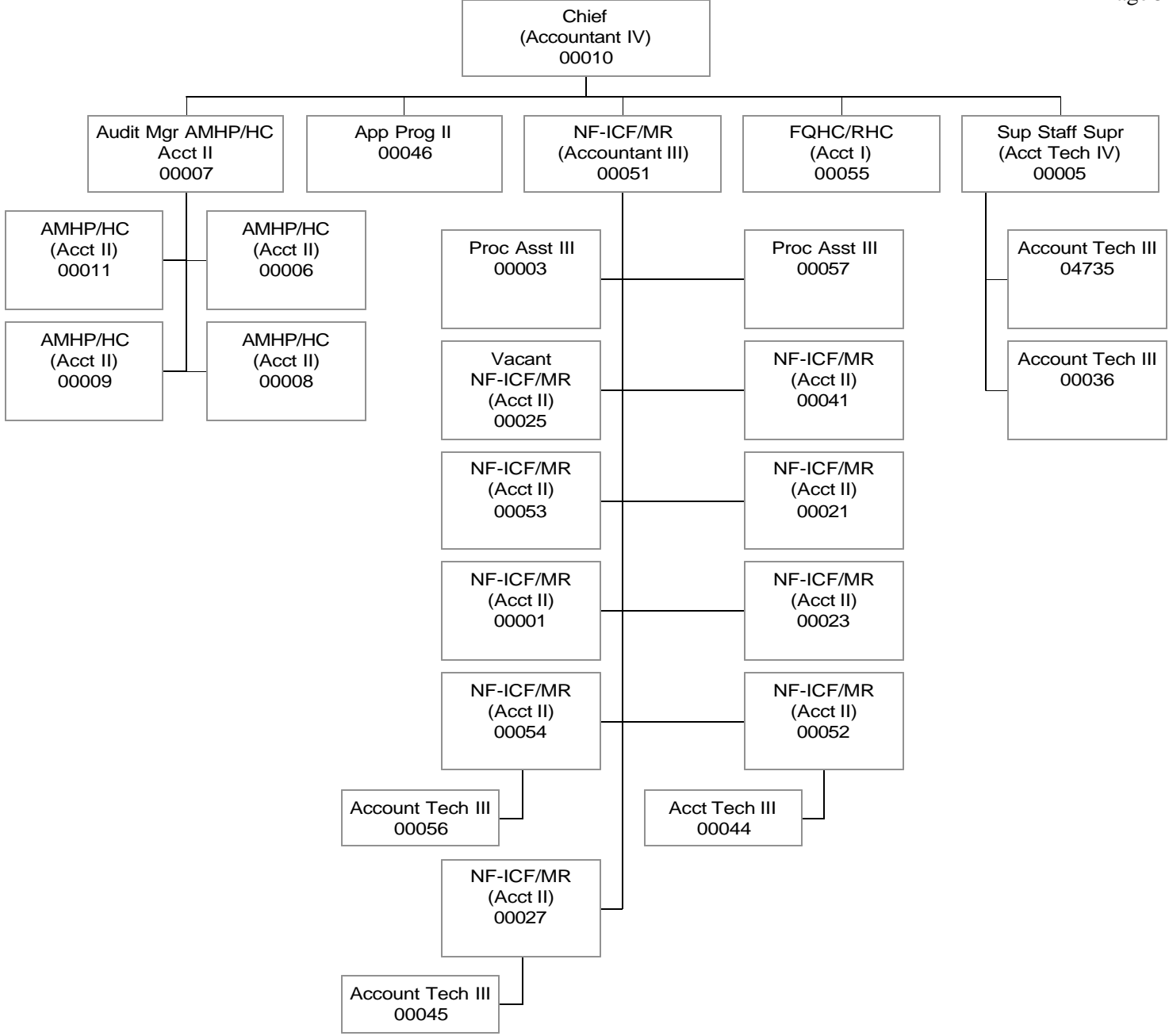

N No. 00-03

supersedes

N No. 84-10

Approval Date 8/2/2000

Eff. Date 4/01/00

RECIPIENT & PROVIDER SERVICES

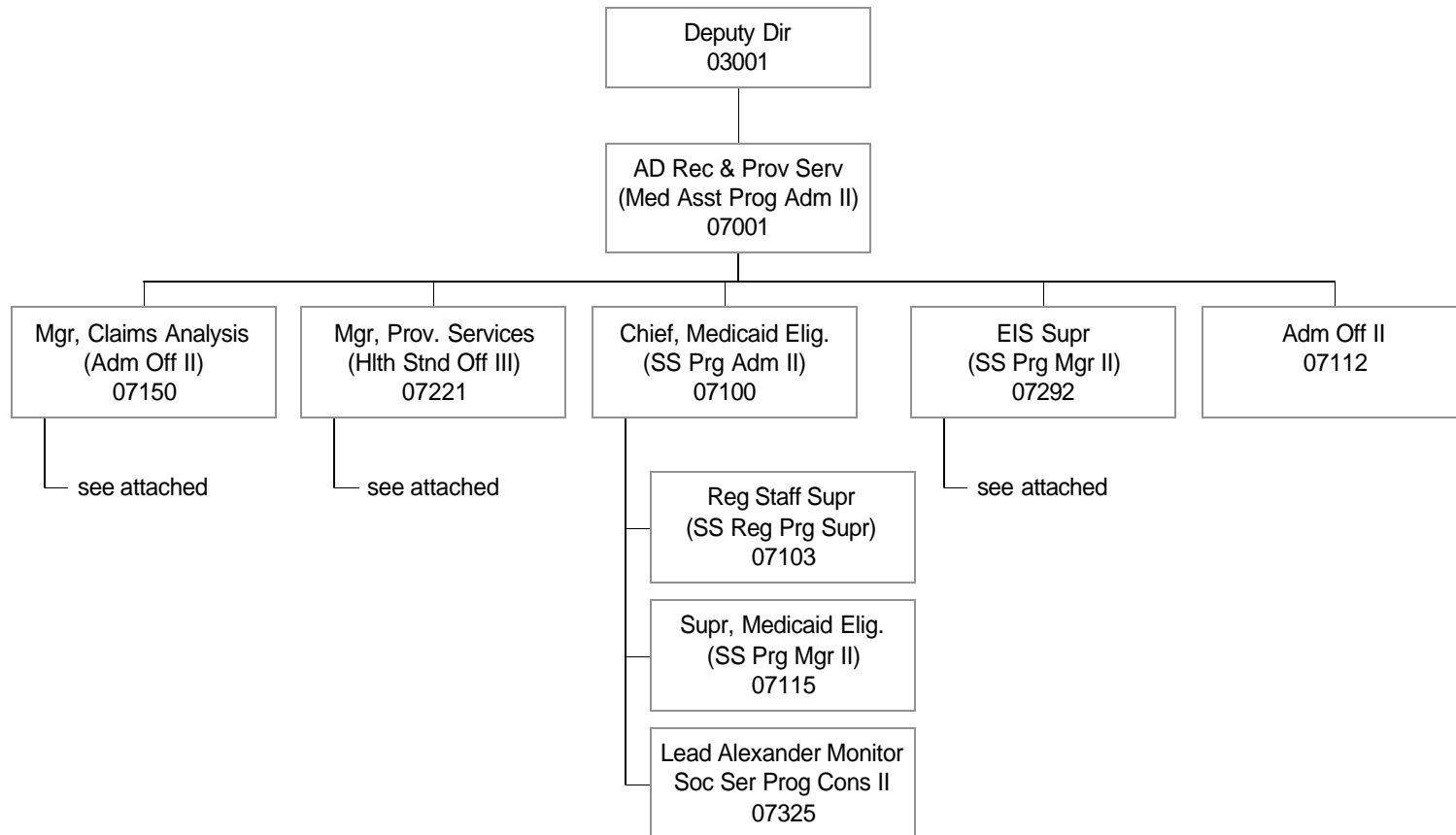

RECIPIENT & PROVIDER SERVICES  
Claims Analysis Unit

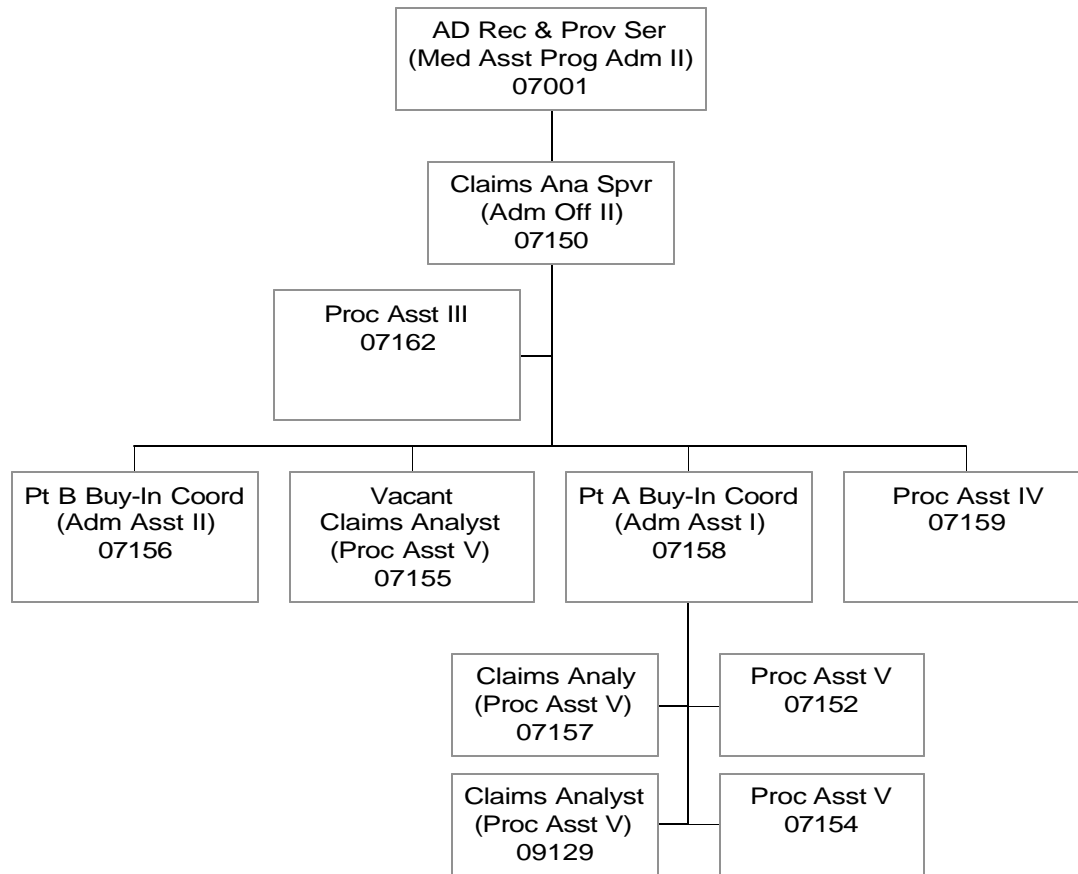

RECIPIENT & PROVIDER SERVICES  
Provider Services Section

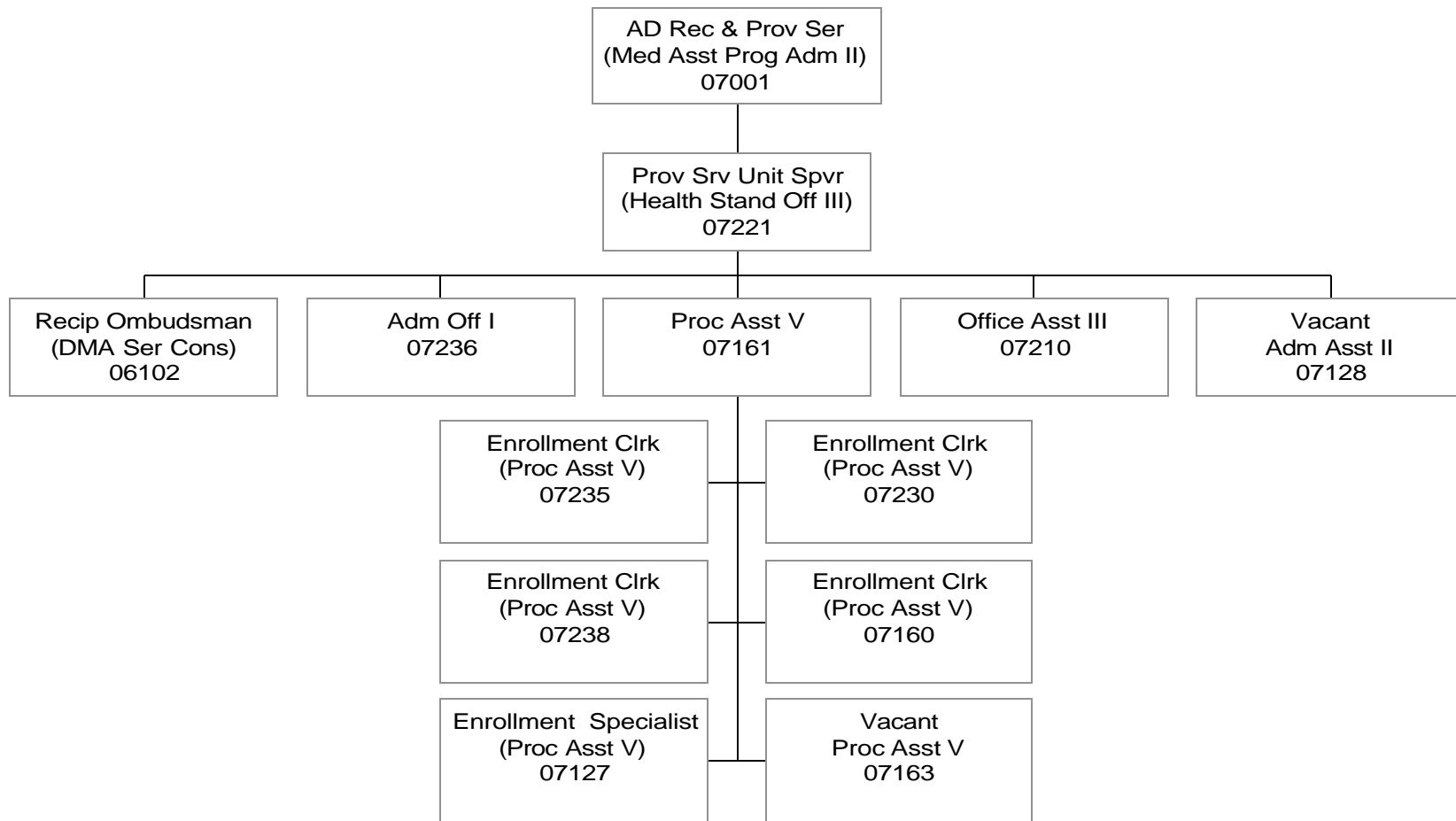

RECIPIENT & PROVIDER SERVICES  
 Medicaid Eligibility Section

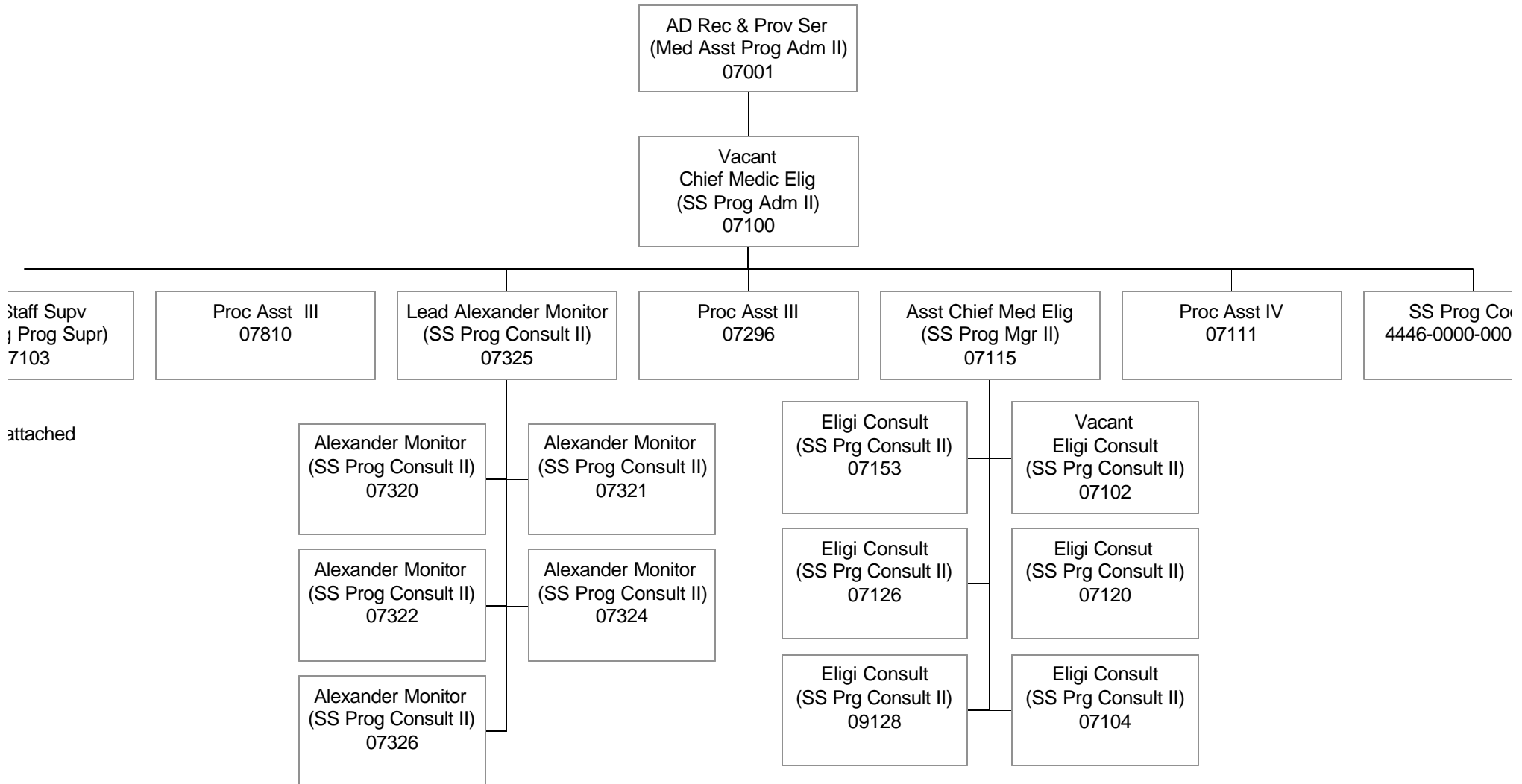

attached

RECIPIENT & PROVIDER SERVICES  
Medicaid Eligibility Section:  
Regional Staff

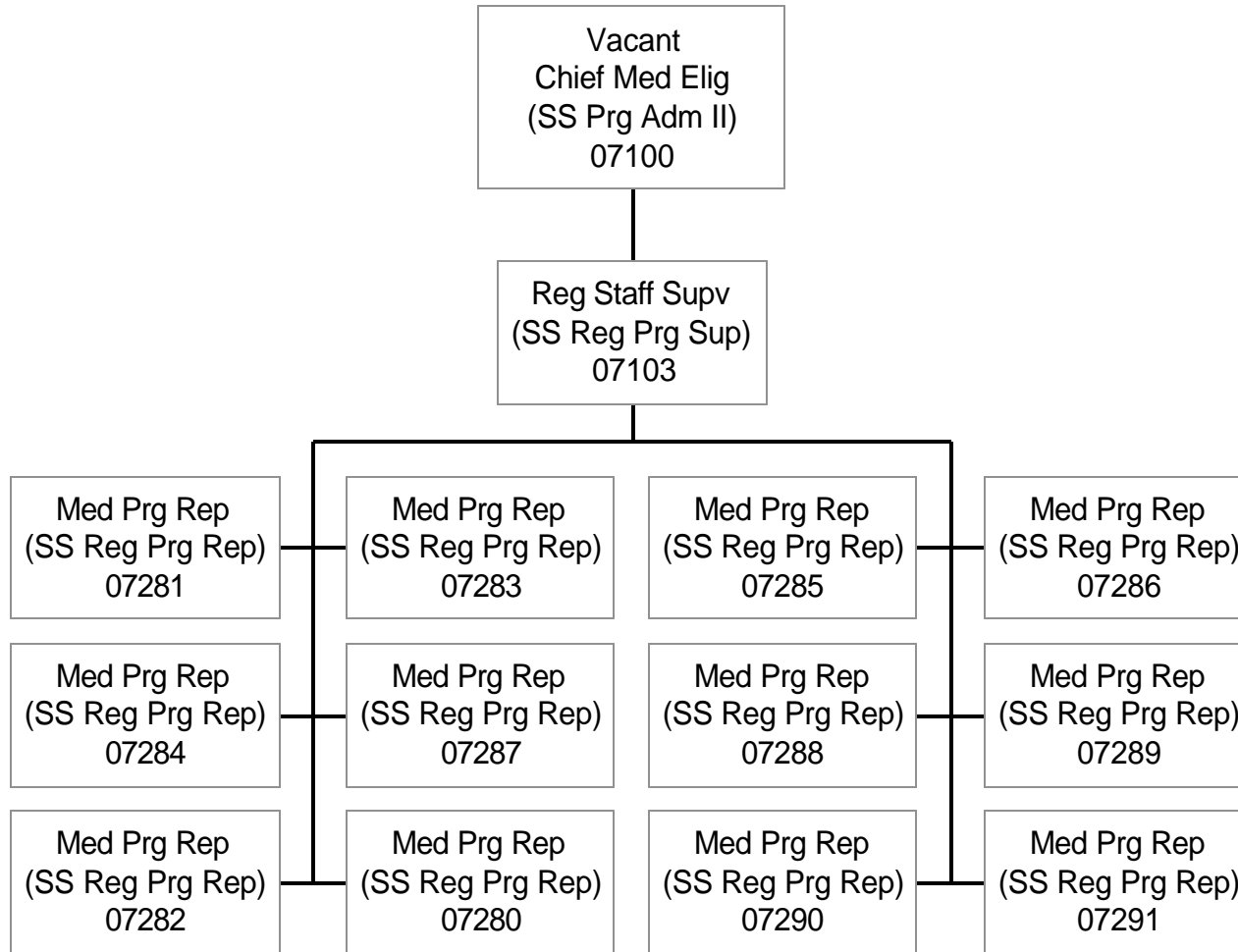



RECIPIENT & PROVIDER SERVICES  
EIS Unit

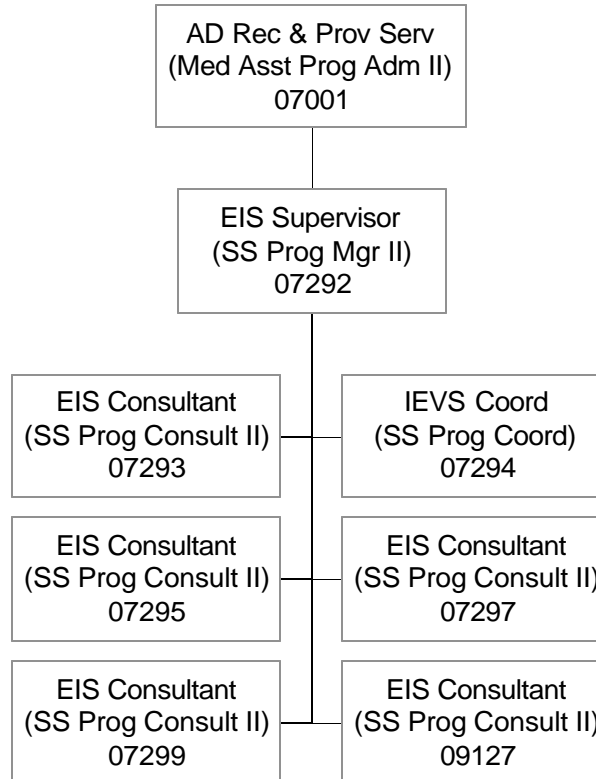

MEDICAL POLICY

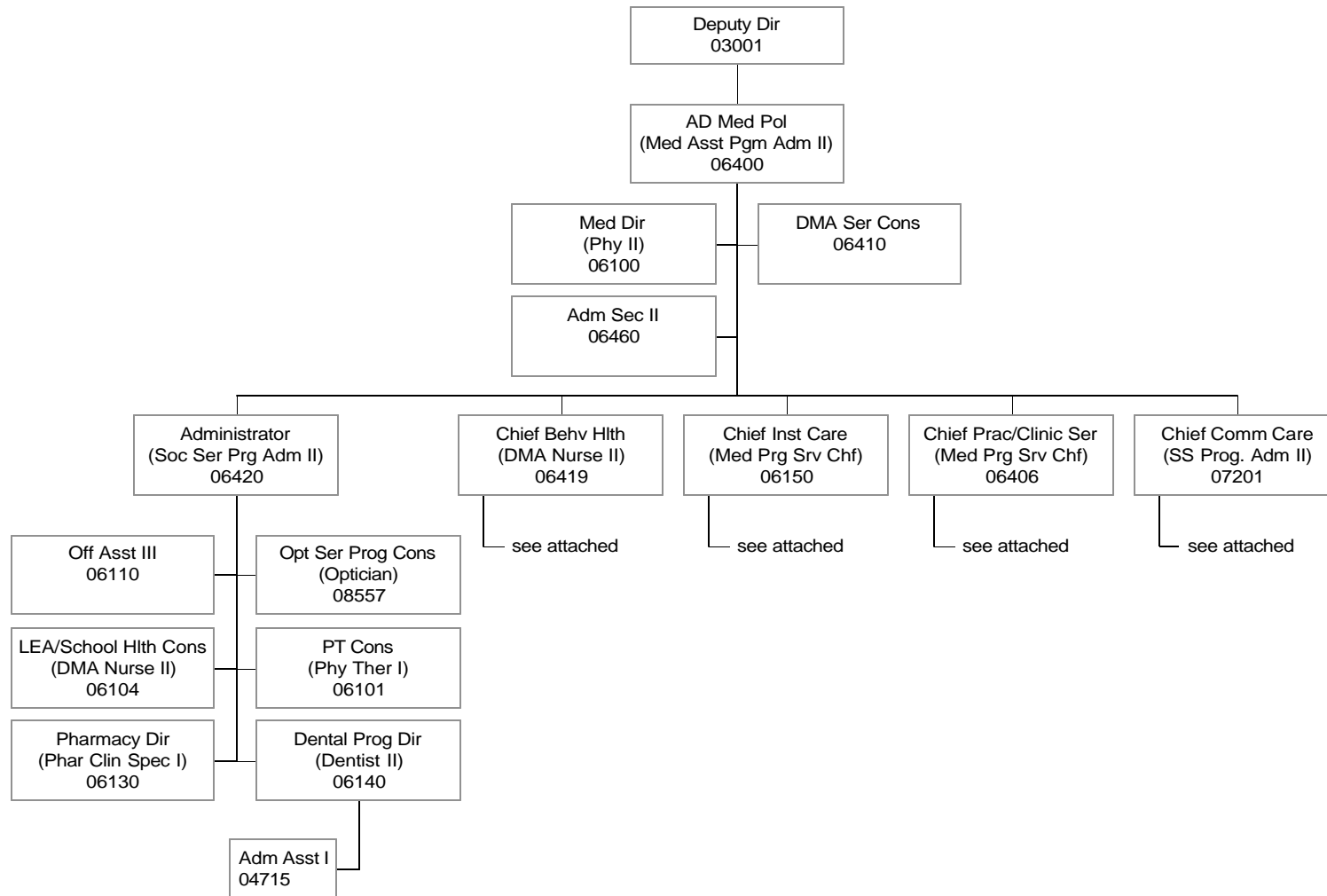

MEDICAL POLICY  
Behavioral Health Services

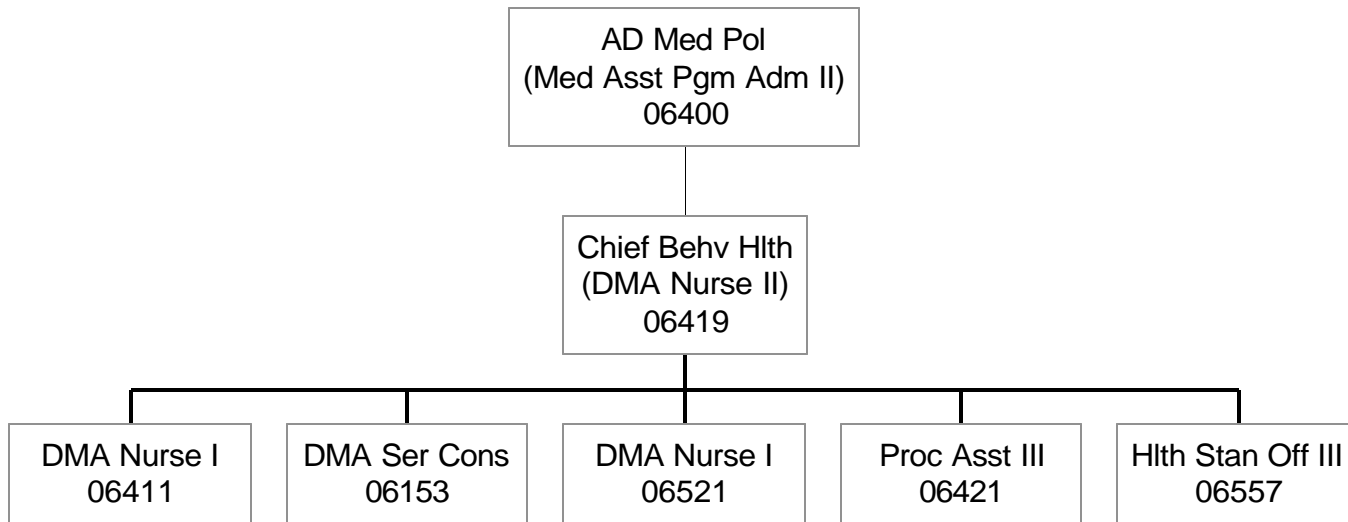

MEDICAL POLICY  
Institutional Services

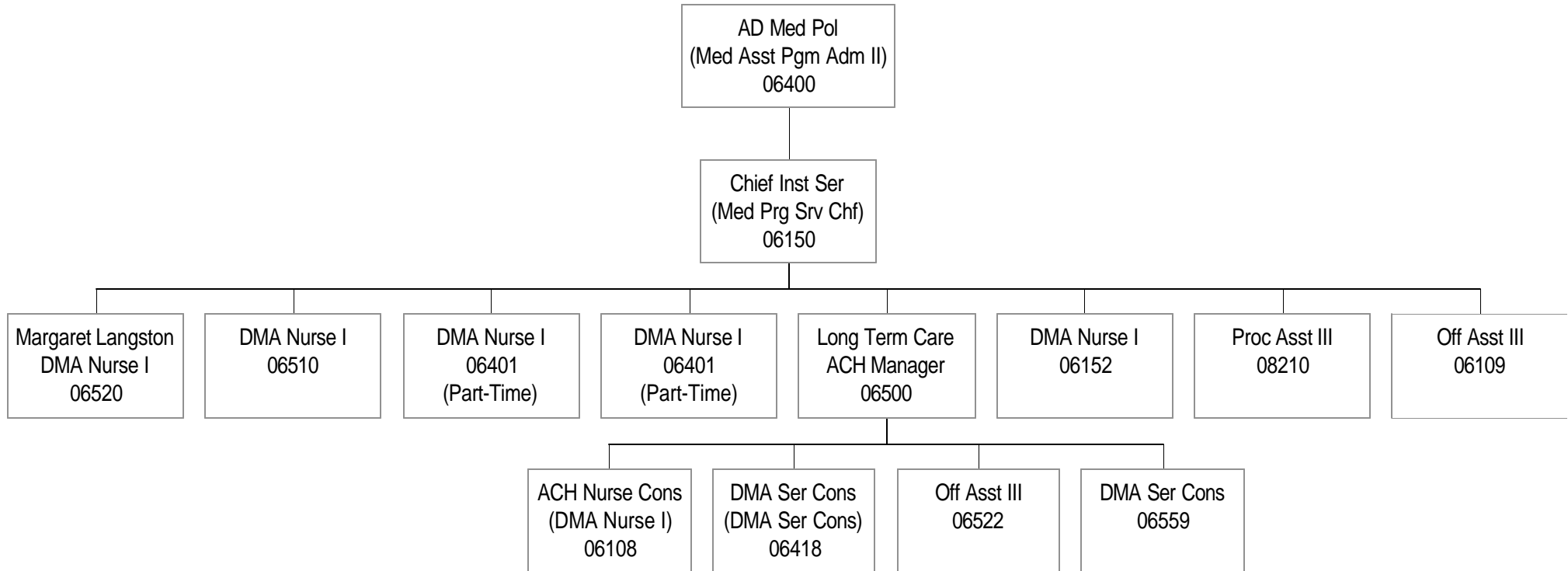

MEDICAL POLICY  
Practitioner and Clinic Services

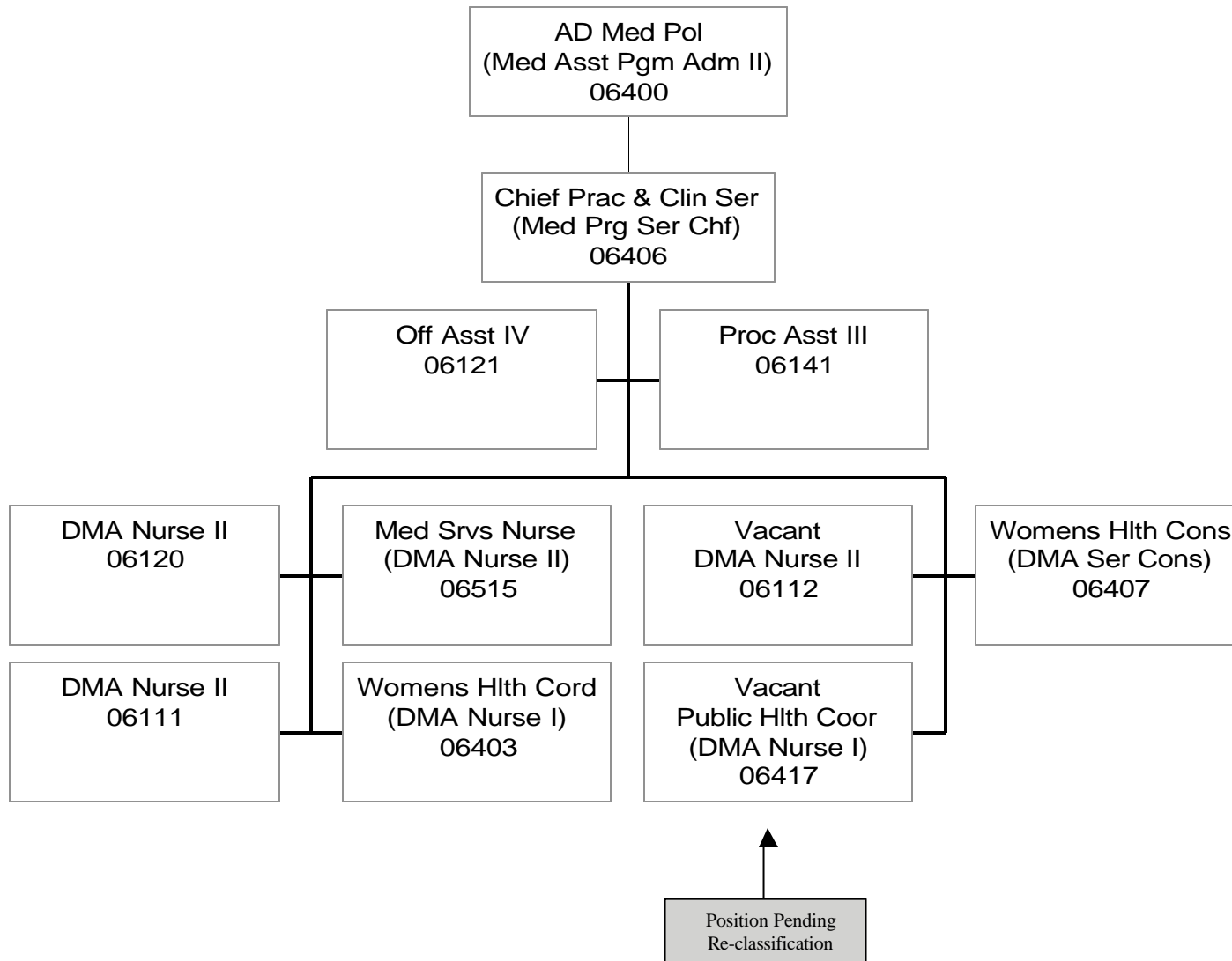

MEDICAL POLICY  
Community Care Section

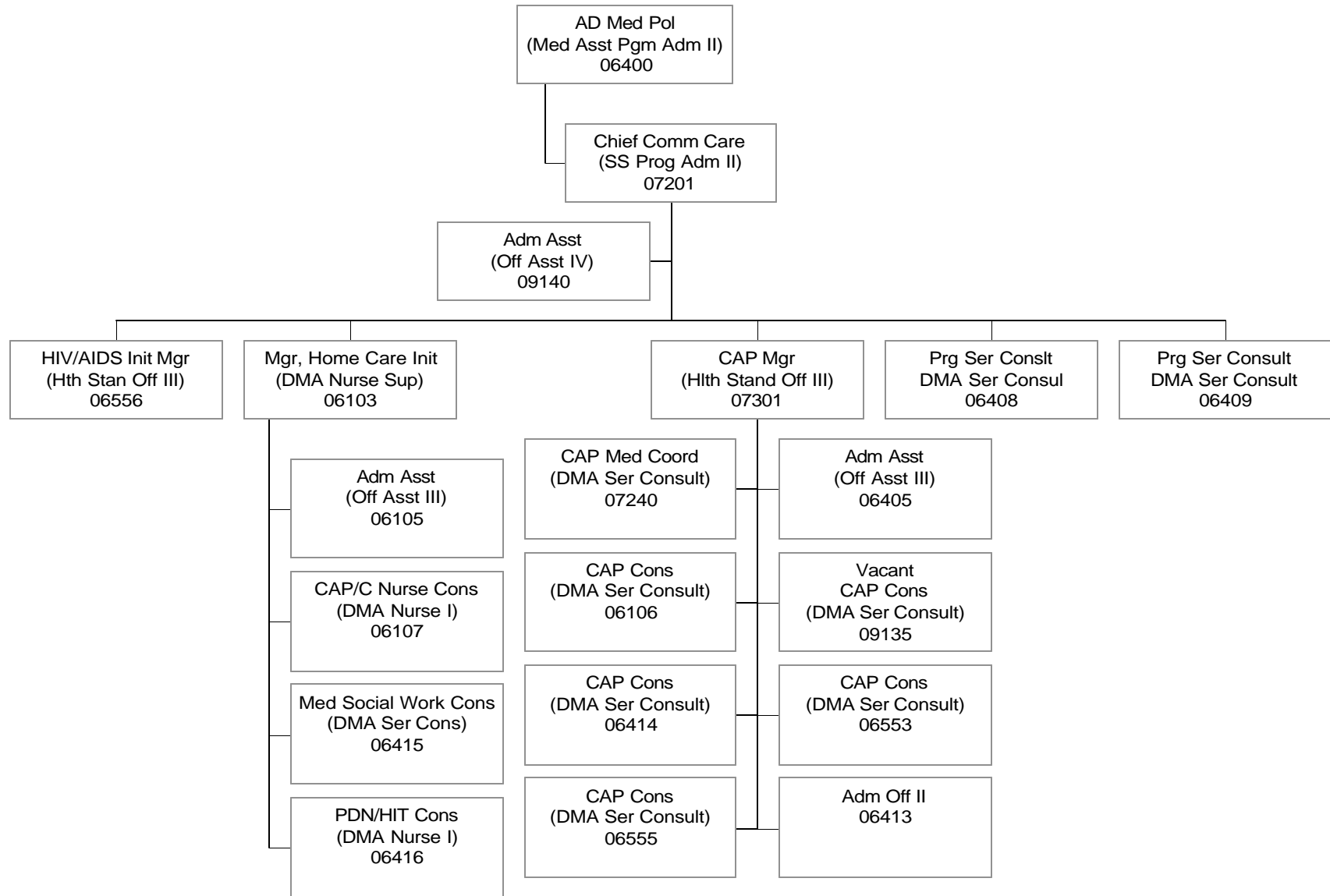

PROGRAM INTEGRITY

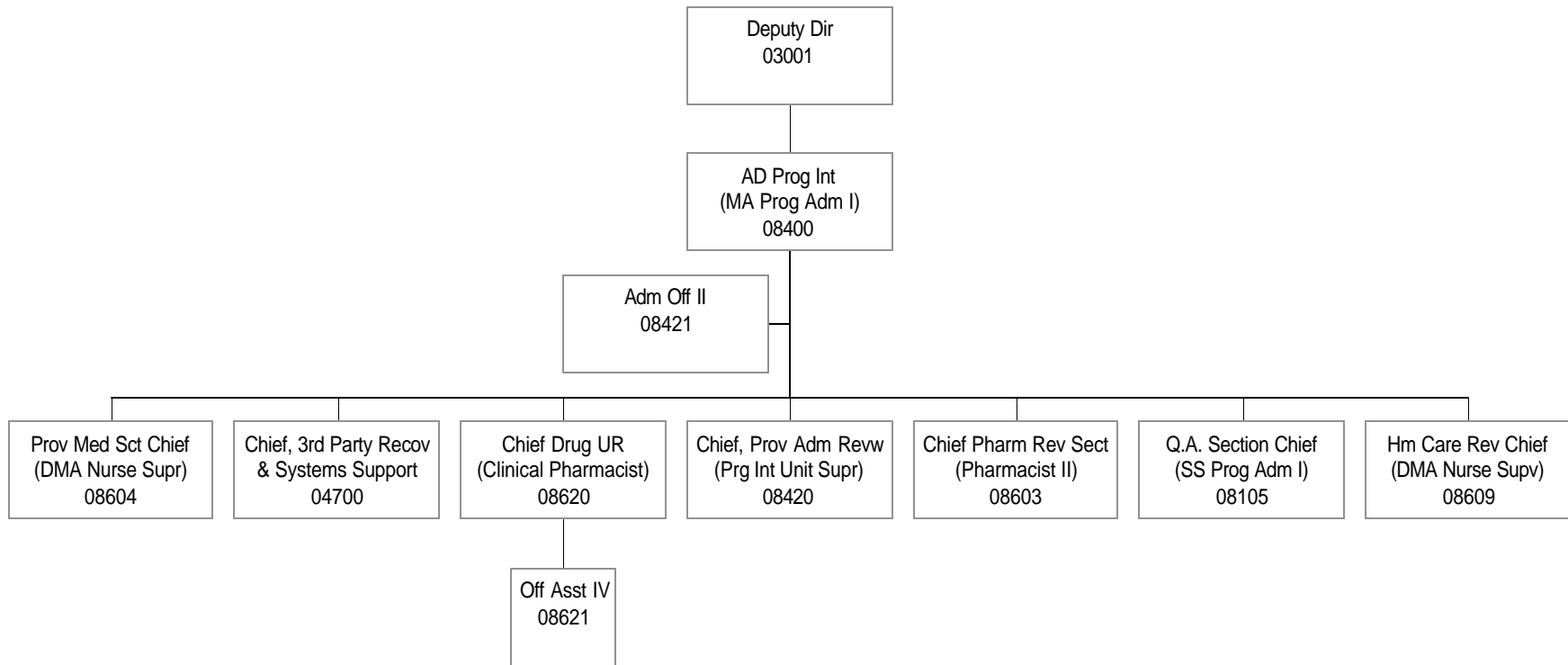

PROGRAM INTEGRITY  
Provider Medical Review Section

Attachment 1.2-B

Page 18

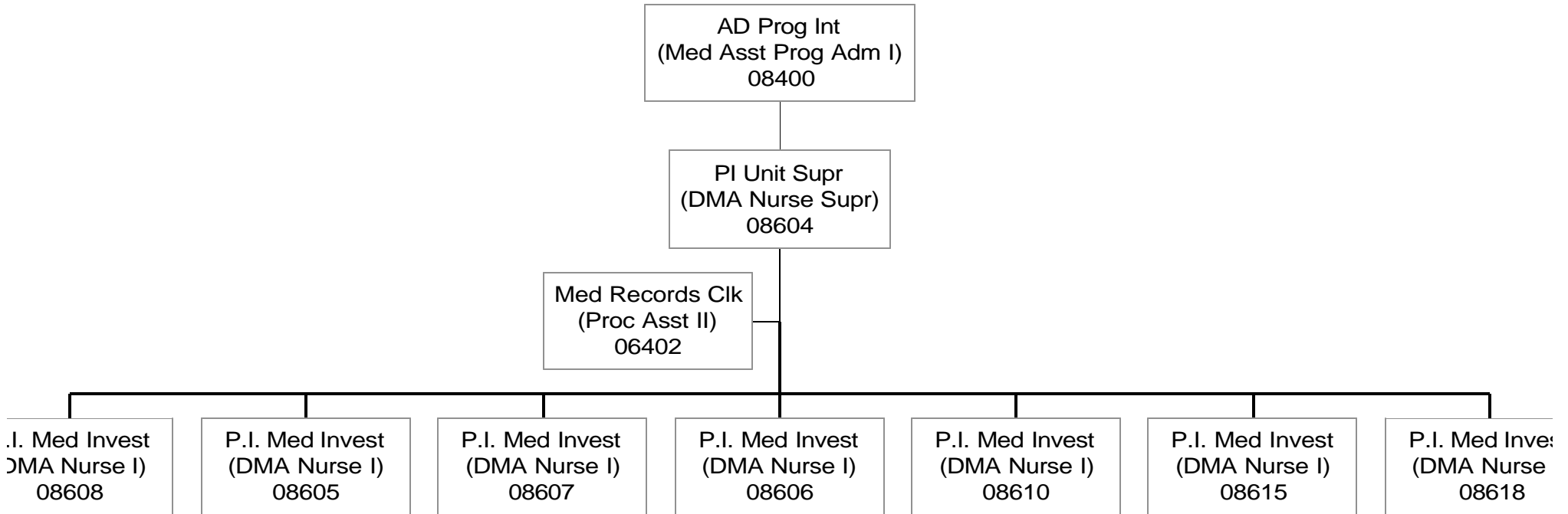



**PROGRAM INTEGRITY**  
**Third Party Recovery & Systems Support Section**

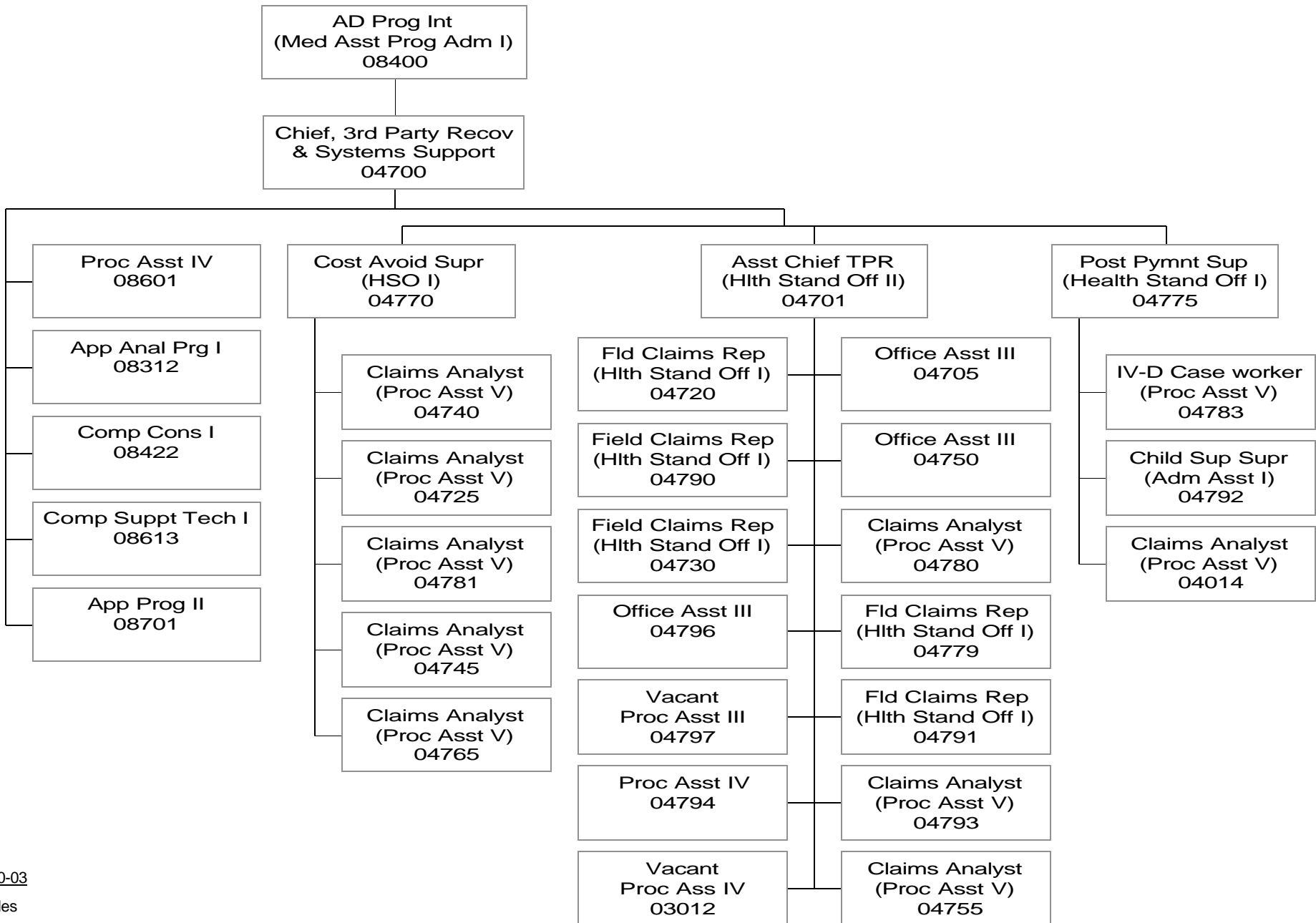

PROGRAM INTEGRITY  
Provider Administration Review Section

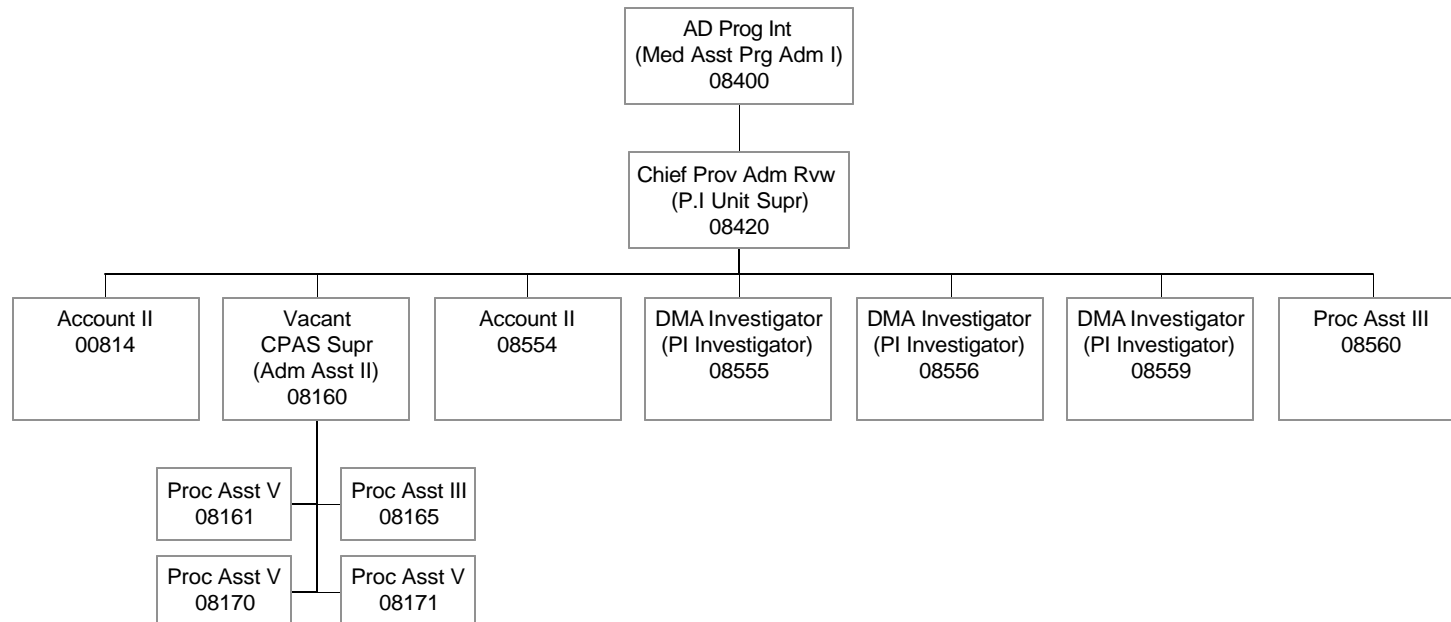

PROGRAM INTEGRITY  
Pharmacy Review Section

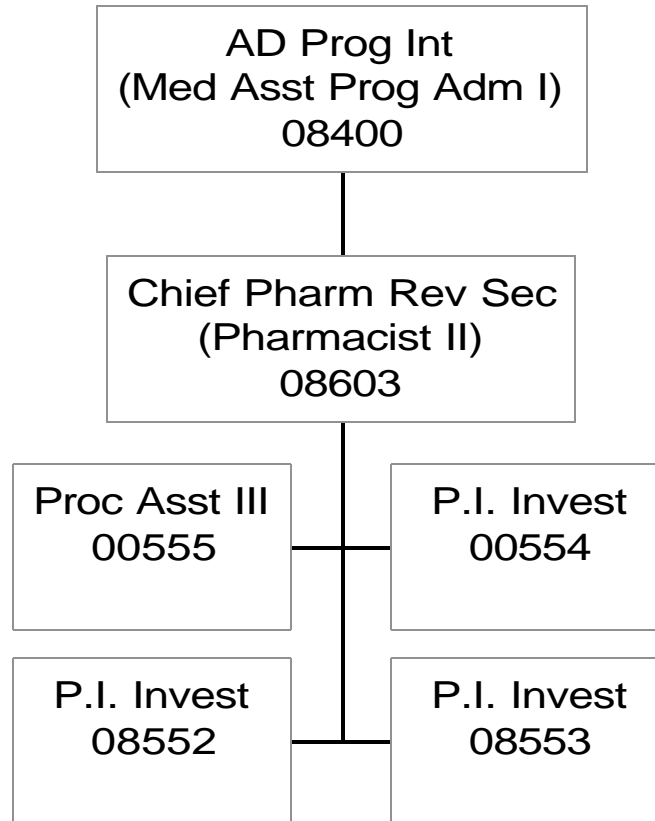

PROGRAM INTEGRITY  
Quality Assurance Section

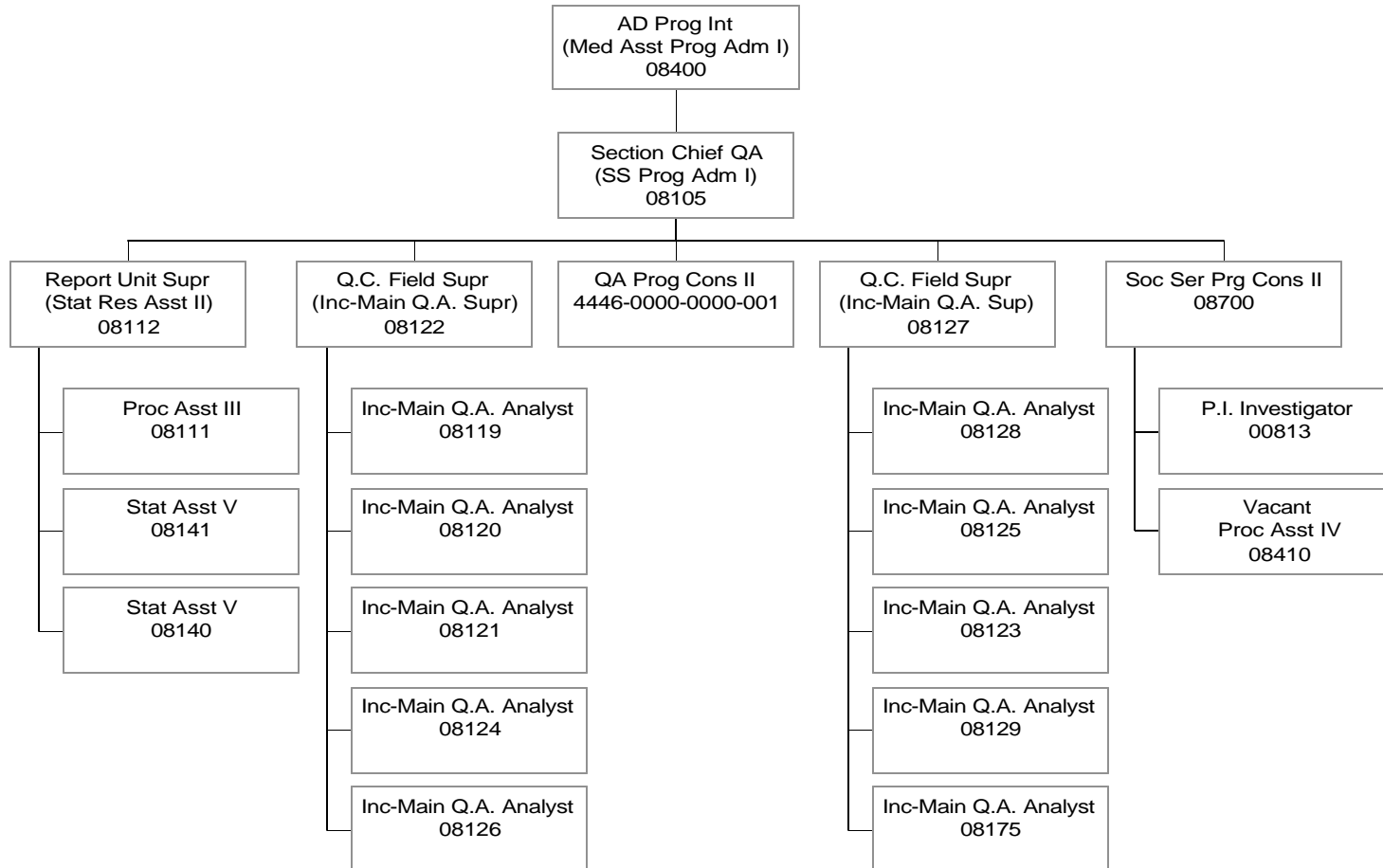

PROGRAM INTEGRITY  
Home Care Review Section

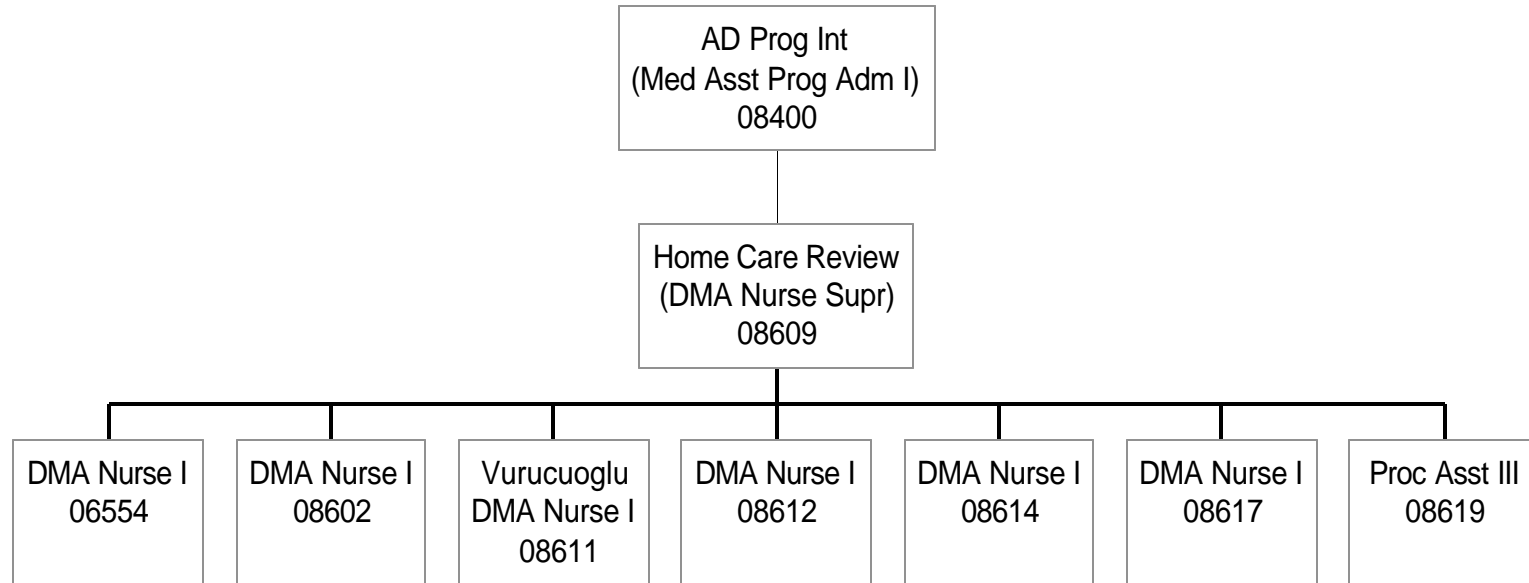

INFORMATION SERVICES

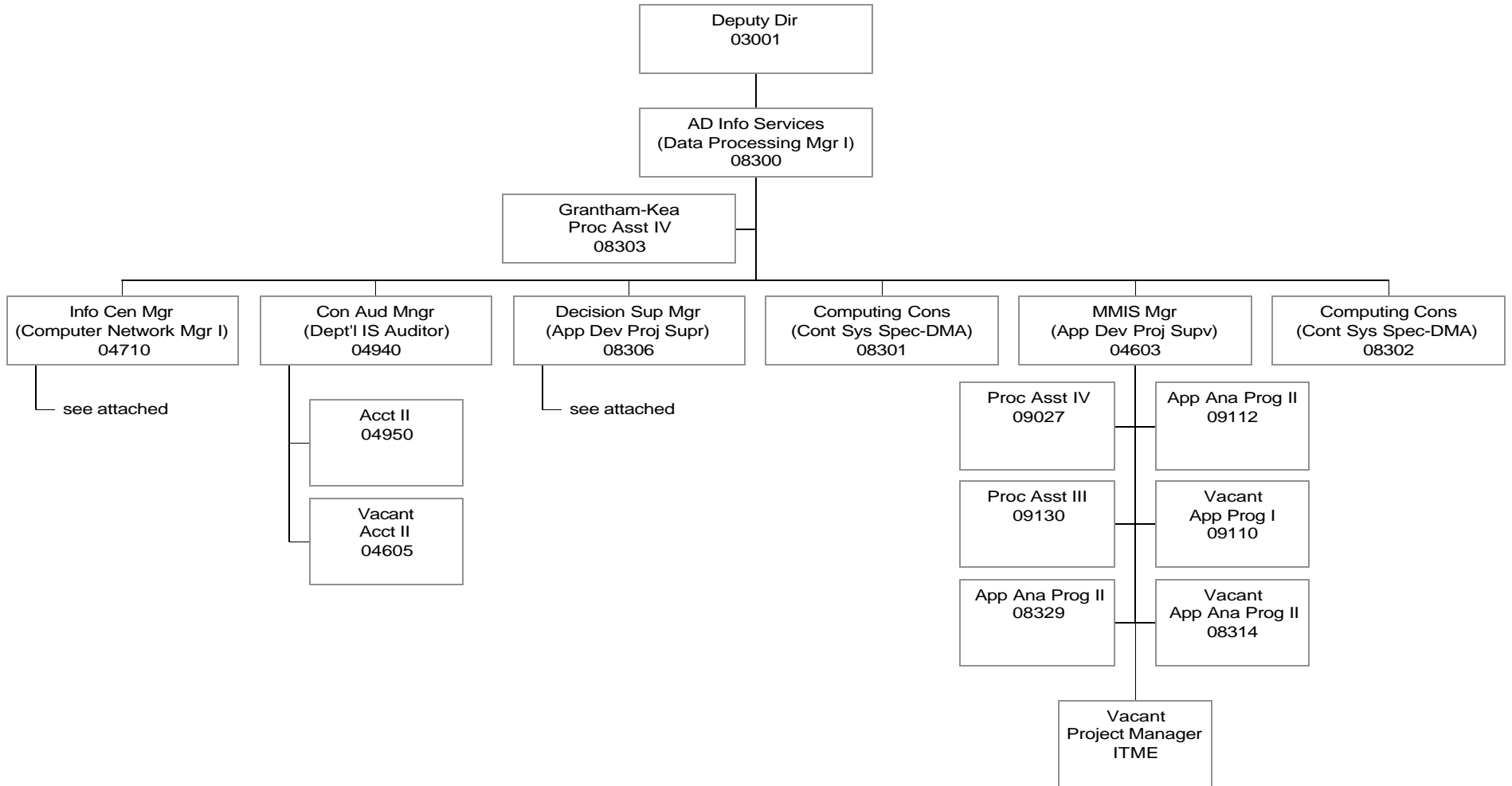

INFORMATION SERVICES  
Information Center Branch

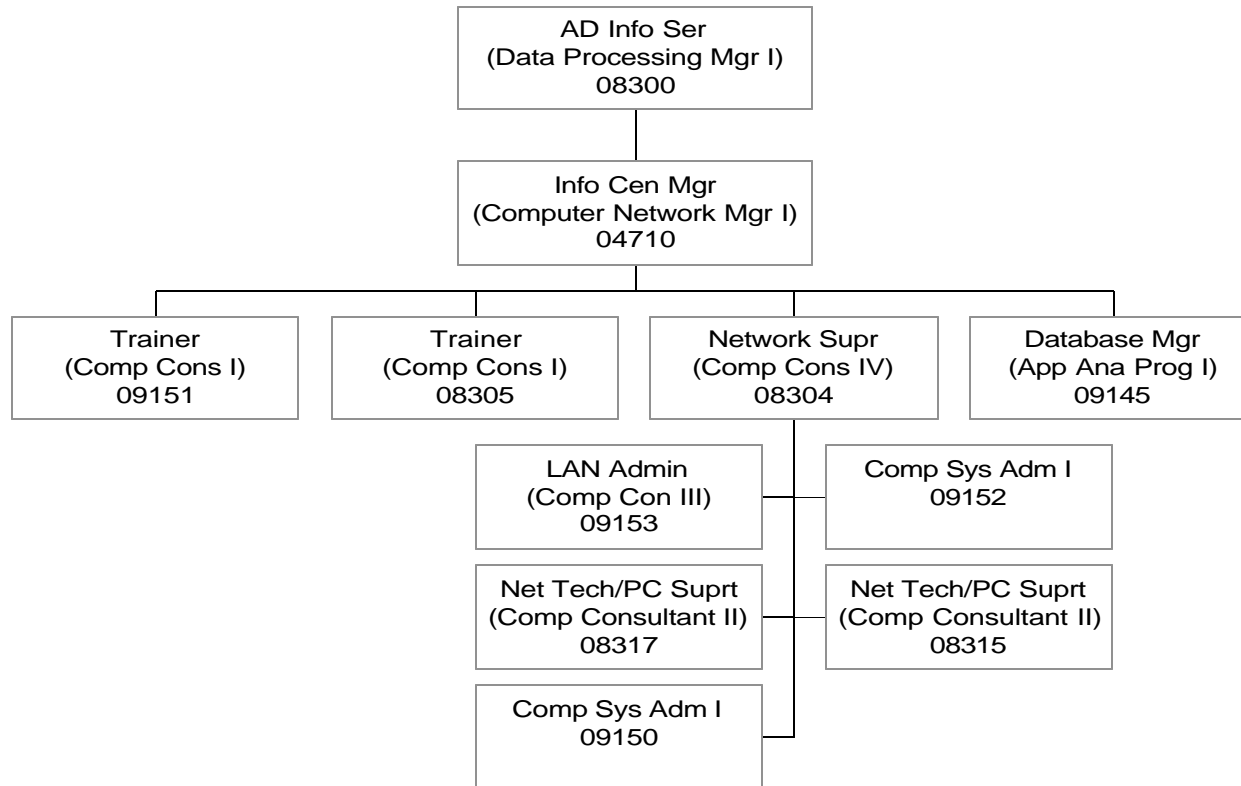

INFORMATION SERVICES  
Decision Support Branch

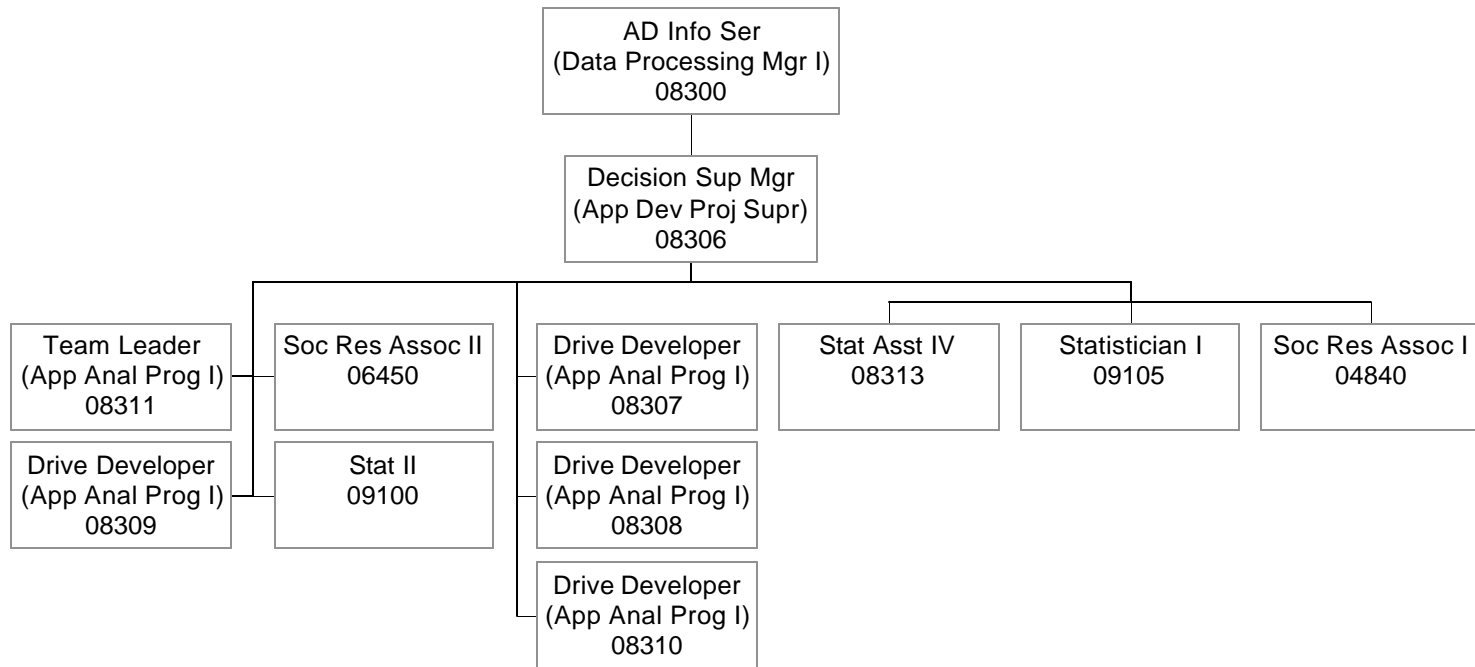



HUMAN RESOURCES

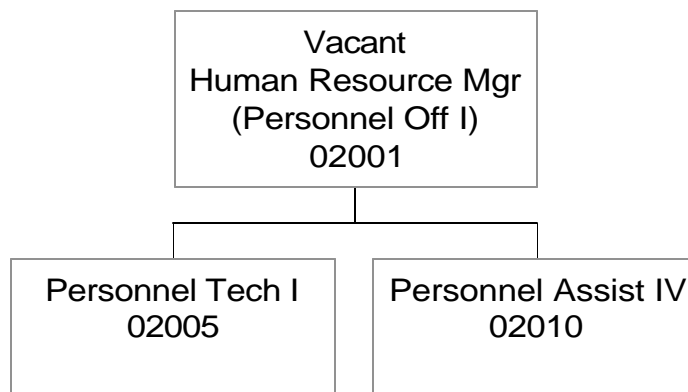

STATE PLAN UNDER TITLE XIX OF THE SOCIAL SECURITY ACT  
MEDICAL ASSISTANCE PROGRAM

STATE North Carolina

PROFESSIONAL MEDICAL STAFF

---

Medical Doctors - 1

Provides consultation to staff, providers, professional associations, utilization review committees, other State agencies regarding medical matters. Provides consultation on difficult claims.

Doctor of Dental Surgery - 1/2

Provides same service for dental program as those listed for Medical Doctor.

Registered Pharmacist - 1

Provides service in pharmacy program as outlined under Medical Doctor.

Registered Nurses - 1

Reviews utilization review reports, contractor reports on utilization of service, patient and provider profiles. Investigates and reports on patterns of over-utilization. Provides consultation on provider fee up-dates.

Health Administrators - 1

Provides program coordination and liaison with contractor, State and Federal Agencies and/or agents, providers, associations of health care professionals. Reviews, analyses Federal and State regulations to ensure program compliance and maintenance of State Plan.

Deputy Director of Medical Assistance - 1

Responsible for assisting Director with overall management and administration of Medical Assistance Program.

Director of Medical Assistance - 1

Responsible for overall management and administration of Medical Assistance Program.

Assistant Director for Medical Policy and Utilization Control - 1

Evaluates utilization patterns and present medical policy for purposes, of proposing, implementing and evaluating those activities structured to reduce unnecessary use of Medicaid services, reviews and updates Medicaid medical policy, provides support in the areas of program integrity, community based services and changes in the level of care of Medicaid recipients in nursing homes and ensures medical review of nursing homes are carried out consistent with federal regulations.

SENT BY OPC- # 84-10  
R.O. ACTION DATE 9-21-84  
OBSLETED BY \_\_\_\_\_

DATED 8-31-84  
EFF DATED 7-1-84  
DATED \_\_\_\_\_

STATE PLAN UNDER TITLE XIX OF THE SOCIAL SECURITY ACT  
MEDICAL ASSISTANCE PROGRAM

STATE North Carolina

PROFESSIONAL MEDICAL STAFF

---

Registered Nurse - 1

Monitors nursing home utilization review activity and grants prior approval for level of care changes recommended by utilization review committees and by on-site inspection of care review teams.

Registered Nurse - 1

Responsible for prior approval of services requested under the Community Alternatives Program for Adults and the Mentally Retarded.

Registered Nurse - 1

Responsible for monitoring and directing utilization review activities to assure compliance with state and federal requirements.

Registered Nurse - 3

Reviews inpatient hospital stays that exceed accepted lengths of stay for diagnosis, reviews SUR reports and medical records, reviews reports on inspection of care reviews for nursing homes and mental hospitals and monitors for corrective action.

Registered Nurse - 5

Provides for Medicaid program integrity by deleting, investigating, reporting, and referring Medicaid fraud, abuse, and over-utilization by providers and recipients participating in the Medicaid program.

Registered Pharmacist (Supervisor) -

Provides for Medicaid program integrity by deleting, investigating, reporting and referring Medicaid fraud, abuse, and over-utilization by providers and recipients participating in the Medicaid program.

Clerical Staff - 7

Support above professional staff.

SENT BY OPC- # 84-10

DATED 8-31-84

R.O. ACTION DATE 9-21-84

EFF DATED 7-1-84

OBSLETED BY \_\_\_\_\_

DATED \_\_\_\_\_

State: North Carolina

The Medicaid Agency elects to enter into a risk contract with an HMO that is not Federally qualified, but meets the requirements of 42 CFR 434.20 (c), is licensed by the Department of Insurance and follow State Licensure Laws and is defined in State Law 58.67, which is incorporated by reference with subsequent changes or amendments.

TN No. 94-16  
Supersedes  
TN No. 86-19

Approval Date June 14 1994

Eff. Date 4/1/94

STATE PLAN UNDER TITLE XIX OF THE SOCIAL SECURITY ACT

State: North Carolina

GROUPS COVERED AND AGENCIES RESPONSIBLE FOR ELIGIBILITY DETERMINATION

---

Agency*	Citation(s)	Groups Covered
---------	-------------	----------------

---

The following groups are covered under this plan.

A. Mandatory Coverage - Categorically Needy and Other Required Special Groups

42 CFR 435.110      1.      Recipients of AFDC

The approved State AFDC plan includes:

Families with an unemployed parent with no time limit.

Families with an unemployed parent for the mandatory 6-month period and an optional extension of months.

Pregnant women with no other eligible children.

AFDC children age 18 who are full-time students in a secondary school or in the equivalent level of vocational or technical training.

The standards for AFDC payments are listed in Supplement 1 of ATTACHMENT 2.6-A.

42 CFR 435.115      2.      Deemed Recipients of AFDC

a. Individuals denied a title IV-A cash payment solely because the amount would be less than \$10.

\* Agency that determines eligibility for coverage.

---

TN No. <u>96-04</u>	Approval Date <u>9-27-96</u>	Effective Date <u>07-01-96</u>
Supersedes		
TN No. <u>92-01</u>		HCFA ID: 7983E

State: North Carolina

---

Agency*	Citation(s)	Groups Covered
		<u>A. Mandatory Coverage - Categorically Needy and other, Required Special Groups (Continued)</u>
		2. Deemed Recipients of AFDC.
	1902(a)(10)(A)(i)(I) of the Act	b. Effective October 1, 1990, participants in a work supplementation program under title IV-A and any child or relative of such individual (or other individual living in the same household as such individuals) who would be eligible for AFDC if there were no work supplementation program, in accordance with section 482(e)(6) of the Act.
	402(a)(22)(A) of the Act	c. Individuals whose AFDC payments are reduced to zero by reason of recovery of overpayment of AFDC funds.
	406(h) and 1902(a)(10)(A) (i)(I) of the Act	d. An assistance unit deemed to be receiving AFDC for a period of four calendar months because the family becomes ineligible for AFDC as a result of collection or increased collection of support and meets the requirements of section 406(h) of the Act.
	1902(a) of the Act	e. Individuals deemed to be receiving AFDC who meet the requirements of section 473(b)(1) or (2) for whom an adoption assistance agreement is in effect or foster care maintenance payments are being made under title IV-E of the Act.

\*Agency that determines eligibility for coverage.

State: North Carolina

---

Agency*	Citation(s)	Groups Covered
---------	-------------	----------------

---

A. Mandatory Coverage - Categorically Needy and Other Required Special Groups (Continued)

3. Qualified Family Members

407(b), 1902  
(a)(10)(A)(i)  
and 1905(m)(1)  
of the Act

See Item A.10, Page 4a

1902(a)(52)  
and 1925 of  
the Act

4. Families terminated from AFDC solely because of earnings, hours of employment, or loss of earned income disregards entitled up to twelve months of extended benefits in accordance with section 1925 of the Act. (This provision expires on September 30, 1998.)

\*Agency that determines eligibility for coverage.

---

TN No. 92-01 Approval Date 10-21-92 Effective Date 1/1/92

Supersedes

TN No. 87-12

HCFA ID: 7983E

State: North Carolina

---

Agency*	Citation(s)	Groups Covered
	A.	<u>Mandatory Coverage - Categorically Needy and Other Required Special Groups (Continued)</u>
42 CFR 435.113	5.	Individuals who are ineligible for AFDC solely because of eligibility requirements that are specifically prohibited under Medicaid. Included are: <ul style="list-style-type: none"><li>a. Families denied AFDC solely because of income and resources deemed to be available from--<ul style="list-style-type: none"><li>(1) Stepparents who are not legally liable for support of stepchildren under a State law of general applicability;</li><li>(2) Grandparents;</li><li>(3) Legal guardians; and</li><li>(4) Individual alien sponsors (who are not spouses of the individual or the individual's parent);</li></ul></li><li>b. Families denied AFDC solely because of the involuntary inclusion of siblings who have income and resources of their own in the filing unit.</li></ul>

\*Agency that determines eligibility for coverage.

---

TN No. <u>92-02</u>	Approval Date <u>10-21-92</u>	Effective Date <u>1/1/92</u>
Supersedes		
TN No. <u>86-19</u>		HCFA ID: 7983E



State: North Carolina

---

Agency	Citation(s)	Groups Covered
--------	-------------	----------------

---

A. Mandatory Coverage - Categorically Needy  
and Other Required Special Groups (Continued)

42 CFR 435.114

6. Individuals who would be eligible for AFDC except for the increase in OASDI benefits under Pub. L.92-336 (July 1, 1972), who were entitled to OASDI in August 1972, and who were receiving cash assistance in August 1972.

— Includes persons who would have been eligible for cash assistance but had not applied in August 1972 (this group was included in this State's August 1972 plan).

— Includes persons who would have been eligible for cash assistance in August 1972 if not in a medical institution or intermediate care facility (this group was included in this State's August 1972 plan).

— Not applicable with respect to intermediate care facilities; State did or does not cover this service.

1902(a)(10)  
(A)(i)(III)  
and 1905(n) of  
the Act

7. Qualified Pregnant Women and Children.

- a. A pregnant woman whose pregnancy has been medically verified who--

(1) Would be eligible for an AFDC cash payment if the child had been born and was living with her;

\*Agency that determines eligibility for coverage.

---

TN No. 92-01  
Supersedes  
TN No. NEW

Approval Date 10-21-92

Effective Date 1/1/92

HCFA ID: 7963E

STATE PLAN UNDER TITLE XIX OF THE SOCIAL SECURITY ACT

State: North Carolina

COVERAGE AND CONDITIONS OF ELIGIBILITY

Citation(s) Groups Covered

A. Mandatory Coverage - Categorically Needy and Other Required Special Groups (Continued)

7. a. (2) Is a member of a family that would be eligible for aid to families with dependent children of unemployed parents if the State had an AFDC-unemployed parents program; or

(3) Would be eligible for an AFDC cash payment on the basis of the income and resource requirements of the State's approved AFDC plan.

1902(a)(10)(A)  
(i) (III) and  
1905(n) of the  
Act

b Children born after September 30, 1983 who are under age 19 and who would be eligible for an AFDC cash payment on the basis of the income and resource requirements of the State's approved AFDC plan.

X Children born after  
Any Date  
(specify optional earlier date)  
who are under age 19 and who would be eligible for an AFDC cash payment on the basis of the income and resource requirements of the State's approved AFDC plan.

STATE PLAN UNDER TITLE XIX OF THE SOCIAL SECURITY ACT

State: North Carolina

COVERAGE AND CONDITIONS OF ELIGIBILITY

Citation(s)

Groups Covered

A. Mandatory Coverage Categorically Needy and  
Other Required special Group (Continued)

1902(a)(10)(A)  
(i)(IV) and  
1902(1)(1)(A)  
and (B) of the  
Act

8. Pregnant women and infants under 1 year of age with family incomes up to 133 percent of the Federal poverty level who are described in section 1902(a)(10)(A)(i)(IV) and 1902(1)(1)(A) and (B) of the Act. The income level for this group is specified in Supplement 1 to ATTACHMENT 2.6-A.

X The State uses a percentage greater than 133 but not more than 185 percent of the Federal poverty level, as established in its State plan, State legislation, or State appropriations as of December 19, 1989.

9. Children:

1902(a)(10)(A)  
(i)(VI)  
1902(1)(1)(C)  
of the Act

a. who have attained 1 year of age but have and not attained 6 years of age, with family incomes at or below 133 percent of the Federal poverty levels.

1902(a)(10)(A)(i)  
(VII) and 1902(1)  
(1)(D) of the Act

b. born after September 30, 1983, who have attained 6 years of age but have not attained 19 years of age, with family incomes at or below 100 percent of the Federal poverty levels.

Income levels for these groups are specified in Supplement 1 to ATTACHMENT 2.6-A.

STATE PLAN UNDER TITLE XIX OF THE SOCIAL SECURITY ACT

State: North Carolina

COVERAGE AND CONDITIONS OF ELIGIBILITY

Citation(s)

Groups Covered

A. Mandatory Coverage - Categorically Needy and Other, Required Special Groups (Continued)

1902(a)(10)  
(A)(i)(V) and  
1905(m) of the  
Act

10. Individuals other than qualified pregnant women and children under item A.7. above who are members of a family that would be receiving AFDC under section 407 of the Act if the State had not exercised the option under section 407(b)(2)(B)(i) of the Act to limit the number of months for which a family may receive AFDC.

1902(e)(5)  
of the Act

11. a. A woman who, while pregnant, was eligible for, applied for, and receives Medicaid under the approved State plan on the day her pregnancy ends. The woman continues to be eligible, as though she were pregnant, for all pregnancy-related and postpartum medical assistance under the plan for a 60-day period (beginning on the last day of her pregnancy) and for any remaining days in the month in which the 60th day falls.

1902(e)(6)  
of the Act

b. A pregnant woman who would otherwise lose eligibility because of an increase in income (of the family in which she is a member) during the pregnancy or the postpartum period which extends through the end of the month in which the 60-day period (beginning on the last day of pregnancy) ends.

STATE PLAN UNDER TITLE XIX OF THE SOCIAL SECURITY ACT

State: North Carolina

COVERAGE AND CONDITIONS OF ELIGIBILITY

Citation(s)

Groups Covered

A. Mandatory Coverage - Categorically Needy and Other Required Special Groups (Continued)

1902(e)(4)  
of the Act

12. A child born to a woman who is eligible for and receiving Medicaid as categorically needy on the date of the child's birth. The child is deemed eligible for one year from birth as long as the mother remains eligible or would remain eligible if still pregnant and the child remains in the same household as the mother.

42 CFR 435.120

13. Aged, Blind and Disabled Individuals Receiving Cash Assistance

X a. Individuals receiving SSI.

This includes beneficiaries eligible spouses and persons receiving SSI benefits pending a final determination of blindness or disability or pending disposal of excess resources under an agreement with the Social Security Administration; and beginning January 1, 1981 persons receiving SSI under section 1619(a) of the Act or considered to be receiving SSI under section 1619(b) of the Act.

X Aged  
X Blind  
X Disabled

TN No. 94-36  
Supersedes  
TN No. 92-01

Approval Date 5-18-95 Effective Date 1-1-95

State: North Carolina

---

Agency\* Citation(s) Groups Covered

---

A. Mandatory Coverage - Categorically Needy and Other  
Required Special Groups (Continued)

435.121 13. \_\_\_ b. Individuals who meet more restrictive requirements for Medicaid than the SSI requirements. (This includes persons who qualify for benefits under section 1619 (a) or who meet the requirements for SSI status under section 1619(b)(1) of the Act and who met the State's more restrictive requirements for Medicaid in the month before the month they qualified for SSI under section 1619(a) or met the requirements under section 1619(b)(1) of the Act. Medicaid eligibility for these individuals continues as long as they continue to meet the 1619 (a) eligibility standard or the requirements of section 1619(b) of the Act.)

1619 (b)(1)of the Act

- \_\_\_ Aged
- \_\_\_ Blind
- \_\_\_ Disabled

The more restrictive categorical eligibility criteria are described below:

(Financial criteria are described in ATTACHMENT 2.6-A).

\*Agency that determines eligibility for coverage.

---

TN No. 94-36  
Supersedes  
TN No. 92-01

Approval Date 5-18-95

Effective Date 1-1-95  
HCFA ID: 7983E

State: North Carolina

Agency\* Citation(s)

Groups Covered

A. Mandatory Coverage - Categorically Needy and Other Required Special Groups (Continued)

1902(a)(10)  
(A)(i)(II)

14. Qualified severely impaired blind and disabled individuals who--

and 1905(q)  
of the Act

- a. For the month preceding the first month of eligibility under the requirements of section 1905(q)(2) of the Act, received SSI, a State supplemental payment under section 1616 of the Act or under section 212 of P.L. 93-66 or benefits under section 1619(a) of the Act and were eligible for Medicaid; or
- b. For the month of June 1987, were considered to be receiving SSI under section 1619(b) of the Act and were eligible for Medicaid. These individuals must--
- (1) Continue to meet the criteria for blindness or have the disabling physical or mental impairment under which the individual was found to be disabled;
  - (2) Except for earnings, continue to meet all nondisability-related requirements for eligibility for SSI benefits;
  - (3) Have unearned income in amounts that would not cause them to be ineligible for a payment under section 1611(b) of the Act;

\*Agency that determines eligibility for coverage.

TN No. 92-01  
Supersedes  
TN No. 87-5

Approval Date 10-21-92

Effective Date 1/1/92

HCFA: 7983E

State: North Carolina

---

Agency*	Citation(s)	Groups Covered
---------	-------------	----------------

---

A. Mandatory Coverage - Categorically Needy and Other Required Special Groups (Continued)

- (4) Be seriously inhibited by the lack of Medicaid coverage in their ability to continue to work or obtain employment; and
- (5) Have earnings that are not sufficient to provide for himself or herself a reasonable equivalent of the Medicaid, SSI (including any Federally administered SSP), or public funded attendant care services that would be available if he or she did have such earnings.

— Not applicable with respect to individuals receiving only SSP because the State either does not make SSP payments or does not provide Medicaid to SSP-only recipients.

\*Agency that determines eligibility for coverage.

---

TN No. <u>92-01</u> Supersede.	Approval Date <u>10-21-92</u>	Effective Date <u>1/1/92</u>
TN No. <u>87-5</u>		HCFA ID: 7983E



State: North Carolina

---

Agency*	Citation(s)	Groups Covered
---------	-------------	----------------

---

A. Mandatory Coverage - Categorically Needy and Other Required-Special Groups (Continued)

1619(b)(3)  
of the Act

— The State applies more restrictive eligibility requirements for Medicaid than under SSI and under 42 CFR 435.121. Individuals who qualify for benefits under section 1619(a) of the Act or individuals described above who meet the eligibility requirements for SSI benefits under section 1619(b)(1) of the Act and who met the State's more restrictive requirements in the month before the month they qualified for SSI under section 1619(a) or met the requirements of section 1619(b)(1) of the Act are covered. Eligibility for these individuals continues as long as they continue to qualify for benefits under section 1619(a) of the Act or meet the SSI requirements under section 1619(b)(1) of the Act.

\*Agency that determines eligibility for coverage.

---

TN No. <u>94-36</u>	Approval Date <u>5-18-95</u>	Effective Date <u>1-1-95</u>
Supersedes		
TN No. <u>92-01</u>		HCFA ID: 7983E

State: North Carolina

Agency*	Citation(s)	Groups Covered
	A. <u>Mandatory Coverage - Categorically Needy and Other Required Special Groups</u> (Continued)	
1634(c) of the Act	15.	Except in States that apply more restrictive eligibility requirements for Medicaid than under SSI, blind or disabled individuals who—  a. Are at least 18 years of age;  b. Lose SSI eligibility because they become entitled to OASDI child's benefits under section 202(d) of the Act or an increase in these benefits based on their disability. Medicaid eligibility for these individuals continues for as long as they would be eligible for SSI, absent their OASDI eligibility.  _____ c. The State applies more, restrictive eligibility requirements than those under SSI, and part or all of the amount of the OASDI benefit that caused SSI/SSP ineligibility and subsequent increases are deducted when determining the amount of countable income for categorically needy eligibility.  _____ d. The State applies more restrictive requirements than those under SSI, and none of the OASDI benefit is deducted in determining the amount of countable income for categorically needy eligibility.
42 CFR 435.122	16.	Except in States that apply more restrictive eligibility requirements for Medicaid than under SSI, individuals who are ineligible for SSI or optional State supplements (if the agency provide Medicaid under §435.230), because of requirements that do not apply under title XIX of the Act.
42 CFR 435.130	17.	Individuals receiving mandatory State supplements

\*Agency that determines eligibility for coverage.

TN No. <u>94-36</u> Supersedes TN No. <u>92-01</u>	Approval Date <u>5-18-95</u>	Effective Date <u>1-1-95</u>
		HCFA ID: . 7983E

State North Carolina

---

Agency*	Citation(s)	Groups Covered
---------	-------------	----------------

---

A. Mandatory Coverage - Categorically Needy and Other Required Special Groups (Continued)

42 CFR 435.131

18. Individuals who in December 1973 were eligible for Medicaid as an essential spouse and who have continued, as spouse, to live with and be essential to the well-being of a recipient of cash assistance. The recipient with whom the essential spouse is living continues to meet the December 1973 eligibility requirements of the State's approved plan for OAA, AB, APTD, or AABD and the spouse continues to meet the December 1973 requirements for having his or her needs included in computing the cash payment.

X In December 1973, Medicaid coverage of the essential spouse was limited to the following group(s):

X Aged      X Blind      X Disabled

     Not applicable. In December 1973, the essential spouse was not eligible for Medicaid.

\*Agency that determines eligibility for coverage.

---

TN No. <u>92-01</u>	Approval Date <u>10-21-92</u>	Effective Dates <u>1/1/92</u>
Supersedes		
TN No. <u>NEW</u>	HCFA ID:	7983E

State. North Carolina

---

Agency*	Citation(s)	Groups covered
	A.	<u>Mandatory Coverage - Categorically Needy and Other Required Special Groups (Continued)</u>
42 CFR 435.132	19.	Institutionalized individuals who were eligible for Medicaid in December 1973 as inpatients of title XIX medical institutions or residents of title XIX intermediate care facilities, if, for each consecutive month after December 1973, they--  a. Continue to meet the December 1973 Medicaid State plan eligibility requirements; and  b. Remain institutionalized; and  c. Continue to need institutional care.
42 CFR 435.133	20.	Blind and disabled individuals who--  a. Meet all current requirements for Medicaid eligibility except the blindness or disability criteria; and  b. Were eligible for Medicaid in December 1973 as blind or disabled; and  c. For each consecutive month after December 1973 continue to meet December 1973 eligibility criteria.

\*Agency that determines eligibility for coverage.

---

TN NO. <u>92-01</u>	Approval Date <u>10-21-92</u>	Effective Date <u>1/1/92</u>
Supersedes		
TN No. <u>NEW</u>		HCFA ID: 7983E

State: North Carolina

---

Agency*	Citation(s)	Groups Covered
	A. <u>Mandatory Coverage Categorically Needy and Other Required Special Groups (Continued)</u>	
42 CFR 435.134	21. Individuals who would be SSI/SSP eligible except for the increase in OASDI benefits under Pub. L. 92-336 (July 1, 1972), who were entitled to OASDI in August 1972, and who were receiving cash assistance in August 1972.	
	— Includes persons who would have been eligible for cash assistance but had not applied in August 1972 (this group was included in this State's August 1972 plan).	
	— Includes persons who would have been eligible for cash assistance in August 1972 if not in a medical institution or nursing facility (this group was included in this State's August 1972 plan).	
	— Not applicable with respect to nursing facilities; the State did or does not cover this service.	

\*Agency that determines eligibility for coverage.

---

TN No. <u>92-01</u>	Approval Date <u>10-21-92</u>	Effective Date <u>1/1/92</u>
Supersedes		
TN No. 87-5		HCFA ID: 7983E

State: North Carolina

---

Agency* Citation(s)	Groups Covered
---------------------	----------------

---

A. Mandatory Coverage - Categorically Needy and Other Required Special Groups (Continued)

42 CFR 435.135

22. Individuals who--

- a. Are receiving OASDI and were receiving SSI/SSP but became ineligible for SSI/SSP after April 1977; and
- b. Would still be eligible for SSI or SSP if cost-of-living increases in OASDI paid under section 215(i) of the Act received after the last month for which the individual was eligible for and received SSI/SSP and OASDI, concurrently, were deducted from income.

\_\_\_ Not applicable with respect to individuals receiving only SSP because the State either does not make such payments or does not provide Medicaid to SSP-only recipients.

\_\_\_ Not applicable because the State applies more restrictive eligibility requirements than those under SSI.

\_\_\_ The State applies more restrictive eligibility requirements than those under SSI and the amount of increase that caused SSI/SSP ineligibility and subsequent increases are deducted when determining the amount of countable income for categorically needy eligibility.

\*Agency that determines eligibility for coverage.

---

TN No. 94-36  
Supersedes  
TN No. 92-01

Approval Date 5-18-95

Effective Date 1-1-95

HCFA ID: 7983E

State: North Carolina

---

Agency*	Citation(s)	Groups Covered
---------	-------------	----------------

---

A. Mandatory Coverage - Categorically Needy and Other Required Special Groups (Continued)

1634 of the Act

23. Disabled widows and widowers who would be eligible for SSI or SSP except for the increase in their OASDI benefits as a result of the elimination of the reduction factor required by section 134 of Pub. L. 98-21 and who are deemed, for purposes of title XIX, to be SSI beneficiaries or SSP beneficiaries for individuals who would be eligible for SSP only, under section 1634(b) of the Act.

— Not applicable with respect to individuals receiving only SSP because the State either does not make these payments or does not provide Medicaid to SSP-only recipients.

— The State applies more restrictive eligibility standards than those under SSI and considers these individuals to have income equaling the SSI Federal benefit rate, or the SSP benefit rate for individuals who would be eligible for SSP only, when determining countable income for Medicaid categorically needy eligibility.

\*Agency that determines eligibility for coverage.

---

TN No. <u>94-36</u>	Approval Date <u>5-18-95</u>	Effective Date <u>01-01-95</u>
Supersedes		
TN No. <u>92-01</u>	HCFA ID:	7983E

State/Territory: North Carolina

---

Agency*	Citation(s)	Groups Covered
---------	-------------	----------------

---

1634(d) of the Act

A. Mandatory Coverage - Categorically Needy and Other Required Special Groups (Continued)

24. Disabled widows, disabled widowers, and disabled surviving divorced spouses who had been married to the insured individual for a period of at least ten years before the divorce became effective, who have attained the age of 50, who are receiving title II payments, and who because of the receipt of title II income lost eligibility for SSI or SSP which they received in the month prior to the month in which they began to receive title II payments, who would be eligible for SSI or SSP if the amount of the title II benefit were not, counted as income, and who are not entitled to Medicare Part A.

— The State applies more restrictive eligibility requirements for its blind or disabled than those of the SSI program.

— In determining eligibility as categorically needy, the State disregards the amount of the title II benefits identified in §1634(d)(1)(A) in determining the income of the individual but does not disregard any more of this income than would reduce the individual's income to the SSI income standard.

— In determining eligibility as categorically needy, the State disregards only part of the amount of the benefit identified in §1634(d)(1)(A) in determining the income of the individual which amount would not reduce the individual's income below the SSI income standard. The amount of these benefits to be disregarded is specified in Supplement 4 to Attachment 2.6-A.

— In determining eligibility as categorically needy, the State chooses not to deduct any of the benefit identified in §1634(d)(1)(A) in determining the income of the individual.

— In determining eligibility as categorically needy, the State disregards all of the amount of the title benefits identified in sec.1634(d)(1)(A) in determining the income of the individual until he becomes entitled to Medicare Part A.

\*Agency that determines eligibility for coverage.

---

TN No. 94-36  
Supersedes  
TN No. 92-11

Approval Date 5-18-95

Effective Date 1-1-95



State: North Carolina

Agency*	Citation(s)	Groups Covered
1902(a)(10)(E)(i) and 1905(p) of the Act	<p>A <u>Mandatory Coverage - Categorically Needy and Other Required Special Groups (Continued)</u></p> <p>25. Qualified Medicare beneficiaries</p>	<p>a. Who are entitled to hospital insurance benefits under Medicare Part A, (but not pursuant to an enrollment under section 1818A of the Act);</p> <p>b. Whose income does not exceed 100 percent of the Federal poverty level; and</p> <p>e- Whose resources do not exceed the amount defined under section 1905(p)(1)(C ) of the Act.</p> <p>(Medical assistance for this group is limited to Medicare cost-sharing as defined in item 3.2 of this plan.)</p>
1902 (a)(10)(E)(ii), 1905(s) and 1905(p)(3)(A)(i) of the Act	<p>26. Qualified disabled and working individuals --</p>	<p>a. Who are entitled to hospital insurance benefits under Medicare Part A under section 1818A of the Act;</p> <p>b. Whose income does not exceed 200 percent of the Federal poverty level; and</p> <p>c. Whose resources do not exceed twice the maximum standard under SSI.</p> <p>d. Who are not otherwise eligible for medical assistance under Title XIX of the Act.</p> <p>(Medical assistance for this group is limited to Medicare Part A premiums under section 1818A of the Act.)</p>

\*Agency that determines eligibility for coverage.

STATE North Carolina

Agency*	Citation(s)	Groups Covered
	A. Mandatory Coverage - Categorically Needy and Other Required Special Groups (Continued)	
1902(a)(10)(E)(iii), 1905 (p)(1)(C), and 1905 (p)(3)(A)(ii) of the Act	27. Specified low-income Medicare beneficiaries-  a. Who are entitled to hospital insurance benefits under Medicare Part A (but not pursuant to an enrollment under section 1818A of the Act);  b. Whose income is greater than 100 percent but does not exceed 120 percent of the Federal poverty level; and  c. Whose resources do not exceed the amount defined in section 1905(p)(1)(C) of the Act.  (Medical assistance for this group is limited to Medicare Part B premiums under section 1839 of the Act.)	
1902(a)(10)(E)(iv), 1905(p)(1)(C)and 1905(p)(3)(A)(ii) of the Act	28. Qualifying Individuals described in section 1905(a)(10)(E)(iv) of the Act  a. Who would be qualified Medicare beneficiaries described in section 1905(p)(1) of the Act except that their income exceeds the income limit established under section 1905(p)(2) of the Act and is at least 120%, but less than 135% of the official poverty line [referred to in section 105(p)(2)], and  b. Whose resources do not exceed the amount defined in 1905(p)(1)(C) of the Act.  (Medical assistance for this group is limited to Medicare Part B premiums under section 1839 of the Act.)	

State: North Carolina

---

Agency*	Citation(s)	Groups Covered
A.	Mandatory Coverage - Categorically Needy and Other Required Special Groups (Continued)	
1634(e)	29.	Each person to whom SSI benefits by reason of disability are not payable for any month solely by reason of clause(i) of (v) of Section 1611(e)(3)(A) shall be treated, for purposes of Title XIX, as receiving SSI benefits for the month.

---

\*Agency that determines eligibility for coverage.

---

TN No. 10-010  
Supersedes  
TN No. NEW

Approval Date 06/17/10

Effective Date 01/01/10

State: North Carolina

Agency*	Citation(s)	Groups Covered
---------	-------------	----------------

B. Optional Groups Other Than the Medically Needy

42 CFR  
435.210  
1902(a)  
(10)(A)(ii) and  
1905(a) of  
the Act

X 1. Individuals described below who meet the income and resource requirements of AFDC, SSI, or an optional State supplement as specified in 42 CFR 435.230, but who do not receive cash assistance.

X The plan covers all individuals as described above and individuals up to 21.

— The plan covers only the following group or groups of individuals:

- Aged
- Blind
- Disabled
- Caretaker relatives
- Pregnant women
- Individuals under the age of \_\_\_\_.

42 CFR  
435.211

— 2. Individuals who would be eligible for AFDC, SSI or an optional State supplement as specified in 42 CFR 435.230, if they were not in a medical institution.

\*Agency that determines eligibility for coverage.

State/Territory: North Carolina

Agency*	Citation(s)	Groups Covered
42 CFR 435.212 & 1902(e)(2) of the Act, P.L. 99-272 (Section 9517) P.L. 101-508 (section 4732)	<p>B . <u>Optional Groups Other Than the Medically Needy</u> (Continued)</p> <p><u>X</u> 3</p>	<p>The State deems as eligible those individuals who became otherwise ineligible for Medicaid while enrolled in an HMO qualified under Title XIII of The Public Health Service Act or a Managed Care Organization (MCO), or a Primary Care Case Management (PCCM) program, but who have been enrolled in the entity for less than the minimum enrollment period listed below. Coverage under this section is limited to MCO or PCCM services and family planning services described in 1905(a)(4)(C).</p>
	<p><u>X</u> The State elects not to guarantee eligibility.</p>	
	<p>___ The State elects to guarantee eligibility. The minimum enrollment period is <u>six</u> months (not to exceed six).</p>	
	<p>The State measures the minimum enrollment period from:</p>	
	<p>___ The date beginning the period of enrollment in the MCO or PCCM, without any intervening disenrollment, regardless of Medicaid eligibility.</p>	
	<p>___ The date beginning the period of enrollment in the MCO or PCCM as a Medicaid patient (including periods when payment is made under this section), without any intervening disenrollment.</p>	
	<p>___ The date beginning the last period of enrollment in the MCO or PCCM as a Medicaid patient (not including periods when payment is made under this section), without any intervening disenrollment of periods of enrollment as a privately paying patient. (A new minimum enrollment period begins each time the individual becomes Medicaid eligible other than under this section.)</p>	

\*Agency that determines eligibility for coverage.

State/Territory: North Carolina

---

Agency*	Citation(s)	Groups Covered
---------	-------------	----------------

---

1932(a)(4) of B. Optional Groups Other Than the Medically  
Needy (Continued)

The Medicaid Agency may elect to restrict the disenrollment of Medicaid enrollees of MCOs, PIHPs, PAHPs, and PCCMs in accordance with the regulations at 42 CFR 438.56. This requirement applies unless a recipient can demonstrate good cause for disenrolling or if he/she moves out of the entity's service area or becomes ineligible.

\_\_\_ Disenrollment rights are restricted for a period of \_\_\_ months (not to exceed 12 months).

During the first three months of each enrollment period the recipient may disenroll without cause. The State will provide notification, at least once per year, to recipients enrolled with such organization of their right to and restrictions of terminating such enrollment.

X No restrictions upon disenrollment rights.

1903(m)(2)(H),  
1902(a) (52)  
of the Act  
P.L. 101-508  
42 CFR 438.56(g)

In the case of individuals who have become ineligible for Medicaid for the brief period described in section 1903(m)(2)(H) and who were enrolled with an MCO, PIHP, PAHP or PCCM when, they became ineligible, the Medicaid agency may elect to reenroll those individuals in the same entity if that entity still has a contract.

X The agency elects to reenroll the above individuals who are ineligible in a month but in the succeeding two months become eligible, into the same entity in which they were enrolled at the time eligibility was lost.

\_\_\_ The agency elects not to reenroll above individuals into the same entity in which they were previously enrolled.

\*Agency that determines eligibility for coverage.

State/Territory: North Carolina

---

Agency*	Citation(s)	Groups Covered
---------	-------------	----------------

---

B. Optional Groups Other Than the Medically Needy (Continued)

42 CFR 435.217

- \_\_\_ 4. A group or groups of individuals who would be eligible for Medicaid under the plan if they were in a NF or an ICF/MR, who but for the provision of home and community-based services under a waiver granted under 42 CFR Part 441, Subpart G would require institutionalization, and who will receive home and community based services under the waiver. The group or groups covered are listed in the waiver request. This option is effective on the effective date of the State's section 1915(c) waiver under which this group(s) is covered. In the event an existing 1915(c) waiver is amended to cover this group(s), this option is effective on the effective date of the amendment.

\*Agency that determines eligibility for coverage.

---

TN No: 08-013  
Supersedes  
TN NO: 92-11

Approval Date: 12/18/08

Effective Date: 07/01/08

HCFA ID: 7983E

State: North Carolina

Agency*	Citation(s)	Groups Covered
	B. <u>Optional Groups other Than The Medically Needy (Continued)</u>	
1902(a)(10) (A)(ii)(VII) of the Act	— 5. Individuals who would be eligible for Medicaid under the plan if they were in a medical institution, who are terminally ill, and who receive hospice care in accordance with a voluntary election described in section 1905(o) of the Act.	
	— The State covers all individuals as described above.	
	— The State covers only the following group or groups of individuals:	
	— Aged	
	— Blind	
	— Disabled	
	— Individuals under the age of-	
	— 21	
	— 20	
	— 19	
	— 18	
	— Caretaker relatives	
	— Pregnant women	

\*Agency that determines eligibility for coverage.

TN No. 92-01  
 Supersedes  
 TN No. NEW

Approval Date 10-21-92

Effective Date 1/1/92

HCFA ID: 7983E



State: North Carolina

Agency*	Citation(s)	Groups Covered
	B. <u>Optional Groups Other Than the Medically Needy (Continued)</u>	
42 CFR 435.220	6. Individuals who would be eligible for AFDC if their work related child care costs were paid from earnings rather than by a State agency as a service expenditure. The State's AFDC plan deducts work-related child care costs from income to determine the amount of AFDC.	
1902(a)(10)(A)(1i) and 1905(a) of the Act	— The State covers all individuals as described above.	
	— The State covers only the following group or groups of	
	individuals:	
	— Individuals under the age of--	
	— 21	
	— 20	
	— 19	
	— 18	
	— Caretaker relatives	
	— Pregnant women	
42 CFR 435.2 22 1902(a)(10)(A)(ii) and 1905(a)(i) of the Act	7. <u>X</u> a. All individuals who are not described in section 1902(a)(10)(A)(i) of the Act, who meet the income and resource requirements of the AFDC State plan, and who are under the age. <u>X</u> 21 — 20 — 19 — 18	

State: North Carolina

---

Agency*	Citation(s)	Groups Covered
---------	-------------	----------------

---

B. Optional Groups Other Than the Medically Needy (Continued)

42 CFR 435.222

- b. Reasonable classifications of individuals described in (a) above, as follows:
  - (1) Individuals for whom public agencies are assuming full or partial financial responsibility and who are:
    - \_\_\_ (a) In foster homes (and are under the age of \_\_\_).
    - \_\_\_ (b) In private institutions (and are under the age of \_\_\_).
    - \_\_\_ (c) In addition to the group under b.(1)(a) and (b), individuals placed in foster homes or private institutions by private, nonprofit agencies (and are under the age of \_).
  - \_\_\_ (2) Individuals in adoptions subsidized in full or part by a public agency (who are under the age of \_\_\_).
  - \_\_\_ (3) Individuals in NFs (who are under the age of \_\_\_). NF services are provided under this plan.
  - \_\_\_ (4) In addition to the group under (b)(3), individuals in ICFs/MR (who are under the age of \_\_\_).

State: North Carolina

---

Agency*	Citation(s)	Groups Covered
---------	-------------	----------------

---

B. Optional Groups Other Than the Medically Needy (Continued)

- (5) Individuals receiving active treatment as inpatients in psychiatric facilities or programs (who are under the age of     ). Inpatient psychiatric services for individuals under age 21 are provided under this plan.
- (6) Other defined groups (and ages), as specified in Supplement 1 of ATTACHMENT 2.2-A.

State: North Carolina

---

Agency*	Citation(s)	Groups Covered
---------	-------------	----------------

---

B. Optional Groups Other Than the Medically Needy (Continued)

1902(a)(10)  
(A)(ii)(VIII)  
of the Act

- x 8. A child for whom there is in effect a State adoption assistance agreement (other than under title IV-E of the Act), who, as determined by the State adoption agency, cannot be placed for adoption without medical assistance because the child has special needs for medical or rehabilitative care, and who before execution of the agreement-
- a. Was eligible for Medicaid under the State's approved Medicaid plan; or
  - b. Would have been eligible for Medicaid if the standards and methodologies of the title IV-E foster care program were applied rather than the AFDC standards and methodologies.

The State covers individuals under the age of--

- 21
- 20
- 19
- X 18

State: North Carolina

---

Agency*	Citation(s)	Groups Covered
---------	-------------	----------------

---

B. Optional Groups Other Than the Medically Needy (Continued)

42 CFR 435.223

9. Individuals described below who would be eligible for AFDC if coverage under the State's AFDC plan were as broad as allowed under title IV-A:

1902(a)(10)  
(A)(ii) and  
1905(a) of  
the Act

- Individuals under the age of--  
 21  
 20  
 19  
 18  
 Caretaker relatives  
 Pregnant women

State: North Carolina

---

Agency*	Citation(s)	Groups Covered
---------	-------------	----------------

---

B. Optional Groups Other Than the Medically Needy (Continued)

42 CFR 435.230

X

10. States using SSI criteria with agreements under sections 1616 and 1634 of the Act.

The following groups of individuals who receive only a State supplementary payment (but no SSI payment) under an approved optional State supplementary payment program that meets the following conditions. The supplement is—

- a. Based on need and paid in cash on a regular basis.
- b. Equal to the difference between the individual's countable income and the income standard used to determine eligibility for the supplement.
- c. Available to all individuals in the State.
- d. Paid to one or more of the classifications of individuals listed below, who would be eligible for SSI except for the level of their income.

- \_\_\_ (1) All aged individuals.
- \_\_\_ (2) All blind individuals.
- \_\_\_ (3) All disabled individuals.

---

TN No. 94-36  
Supersedes  
TN No. 92-01

Approval Date 5-18-95

Effective Date 1-1-95  
HCFA ID: 7983E

State: North Carolina

Agency*	Citation(s)	Groups Covered
---------	-------------	----------------

B. Optional Groups Other Than the Medically Needy (Continued)

<u>X</u>	(4)	Aged individuals in adult care homes or other group living arrangements as defined under SSI.
42 CFR 435.230	<u>X</u>	Blind individuals in adult care homes or other group living arrangements as defined under SSI.
	<u>X</u>	Disabled individuals in adult care homes or other group living arrangements as defined under SSI.
	—	Individuals receiving a Federally administered optional State supplement that meets the conditions specified in 42 CFR 435.230.
	—	Individuals receiving a State administered optional State supplement that meets the conditions specified in 42 CFR 435.230.
	—	Individuals in additional classifications approved by the Secretary as follows:

State: North Carolina

---

Agency*	Citation(s)	Groups Covered
---------	-------------	----------------

---

B. Optional Groups Other Than the Medically Needy (Continued)

The supplement varies in income standard by political subdivisions according to cost-of-living differences.

Yes.

No.

The standards for optional State supplementary payments are listed in Supplement 6 of ATTACHMENT 2.6-A.



State: North Carolina

---

Agency*	Citation(s)	Groups Covered
---------	-------------	----------------

---

B. Optional Groups Other Than the Medically Needy (Continued)

- |   |   |  |
|---|---|--|
| 435.121<br>1902(a)(10)<br>(A)(ii)(XI)<br>of the Act | — 11. <u>Section 1902(f) States and SSI criteria<br/>States without agreements under section<br/>1616 or 1634 of the Act.</u> | <p>The following groups of individuals who receive a State supplementary payment under an approved optional State supplementary payment program that meets the following conditions. The supplement is—</p> <ul style="list-style-type: none"><li>a. Based on need and paid in cash on a regular basis.</li><li>b. Equal to the difference between the individual's countable income and the income standard used to determine eligibility for the supplement.</li><li>c. Available to all individuals in each classification and available on a Statewide basis.</li><li>d. Paid to one or more of the classifications of individuals listed below:<ul style="list-style-type: none"><li>— (1) All aged individuals.</li><li>— (2) All blind individuals.</li><li>— (3) All disabled individuals.</li></ul></li></ul> |
|---|---|--|

STATE North Carolina

---

Agency*	Citation(s)	Groups Covered
---------	-------------	----------------

---

Intentionally Left Blank

Agency*	Citation(s)	Groups Covered
1902(a)(10) (A)(ii)(X) and 1902(m) (1) and (3) of the Act, P.L. 99-509	<u>X</u> 14.	In addition to individuals covered under item B.7(a), individuals--  (a) Who are 65 years of age or older or are disabled--
(Section 9402(a) and (b))	<u>X</u>	As determined under section 1614(a)(3)of the Act; or
	—	As determined under more restrictive categorical eligibility criteria specified under item A.9(b) of this Attachment.
	(b)	Whose income does not exceed the income level (established at an amount up to 100 percent of the Federal nonfarm income poverty line) specified in Supplement 1 to <u>ATTACHMENT 2.6-A</u> for a family of the same size; and
	(c)	Whose resources do not exceed the maximum amount allowed--
	<u>X</u>	Under SSI;
	—	Under the State's more restrictive financial criteria; or
	—	Under the State's medically needy program as specified in <u>ATTACHMENT 2.6-A.</u>

\*Agency that determines eligibility for coverage.

---

Agency*	Citation(s)	Groups Covered
---------	-------------	----------------

---

1902(a)(47)  
and 1920 of the  
Act, P.L. 99-509  
(Section 9407)

15. Pregnant women who meet the applicable income levels for the categorically needy specified in this plan under ATTACHMENT 2.6-A who are determined eligible by a qualified provider during a presumptive eligibility period in accordance with section 1920 of the Act.

C. Optional Coverage of the Medically Needy

435.301

This plan includes the medically needy.

No.

Yes. This plan covers:

1. Pregnant women who, except for income and resources, would be eligible as categorically needy.

\*Agency that determines eligibility for coverage.

---

TN No. 87-18  
Supersedes  
TN No. 87-5

Approval Date 1/5/88

Effective Date 10/1/87

State: North Carolina

---

Agency*	Citation(s)	Groups Covered
---------	-------------	----------------

---

B. Optional Groups Other Than the Medically Needy  
(Continued)

- (4) Aged individuals in adult care homes or other group living arrangements as defined under SSI.
- (5) Blind individuals in adult care homes or other group living arrangements as defined under SSI.
- (6) Disabled individuals in adult care homes or other group living arrangements as defined under SSI.
- (7) Individuals receiving federally administered optional State supplement that meets the conditions specified in 42 CFR 435.230.
- (8) Individuals receiving a State administered optional State supplement that meets the conditions specified in 42 CFR 435.230.
- (9) Individuals in additional classifications approved by the Secretary as follows:

Revision: HCFA-PM-91-4  
AUGUST 1991

(BPD)

ATTACHMENT 2.2-A  
Page 18a  
OMB NO.: 0938

State: North Carolina

---

Agency*	Citation(s)	Groups Covered
---------	-------------	----------------

---

B. Optional Groups Other Than the Medically Needy  
(Continued)

The supplement varies in income standard by political subdivisions according to cost-of-living differences.

Yes

No

The standards for optional State supplementary payments are listed in Supplement 6 of ATTACHMENT 2.6-A.

---

TN No. 94-36  
Supersedes  
TN No. 92-01

Approval Date 5-18-95

Effective Date 1-1-95  
HCFA ID: 7983E

State: North Carolina

Agency*	Citation(s)	Groups Covered
---------	-------------	----------------

B. Optional Groups Other Than the Medically Needy (Continued)

42 CFR 435.231 1902(a)(10) (A)(ii)(V) of the Act	— 12.	Individuals who are in institutions for a least 30 consecutive days and who are eligible under a special income level. Eligibility begins on the first day of the 30-day period. These individuals meet the income standards specified in Supplement 1 to <u>ATTACHMENT 2.6-A</u> .
	—	The State covers all individuals as described above.
	—	The State covers only the following group or groups of individuals:
1902(a)(10)(A) (ii) and 1905(a) of the Act	—	Aged
	—	Blind
	—	Disabled
	—	Individuals under the age of-
	—	21
	—	20
	—	19
	—	18
	—	Caretaker relatives
	—	Pregnant women

State: North Carolina

Agency*	Citation(s)	Groups Covered
---------	-------------	----------------

B. Optional Groups Other Than the Medically Needy  
 (Continued)

1902(e)(3)  
 of the Act

—

13. Certain disabled children age 18 or under who are living at home, who would be eligible for Medicaid under the plan if they were in a medical institution, and for whom the State has made a determination as required under section 1902(e)(3)(B) of the Act.

Supplement 3 to ATTACHMENT 2.2-A describes the method that is used to determine the cost effectiveness of caring for this group of disabled children at home.

1902(a)(10)  
 (A)(ii)(IX)  
 and 1902(l)  
 of the Act

X

14. The following individuals who are not mandatory categorically needy whose income does not exceed the income level (established at an amount above the mandatory level and not more than 185 percent of the Federal poverty income level) specified in Supplement 1 to ATTACHMENT 2.6-A for a family of the same size, including the woman and unborn child or infant and who meet the resource standards specified in Supplement 2 to ATTACHMENT 2.6-A:

- a. Women during pregnancy (and during the 60-day period beginning on the last day of pregnancy); and
- b. Infants under one year of age.



State: North Carolina

---

Agency*	Citation(s)	Groups Covered
---------	-------------	----------------

---

B. Optional Groups Other Than the Medically Needy  
(Continued)

1902(a)  
(10)(A)  
(ii)(IX)  
and 1902(l)(1)  
(D) of the Act

—

15. The following individuals who are not mandatory categorically needy, who have income that does not exceed the income level (established at an amount up to 100 percent of the Federal poverty level) specified in Supplement 1 of ATTACHMENT 2.6-A for a family of the same size.

Children who are born after September 30, 1983 and who have attained 6 years of age but have not attained--

— 7 years of age; or

— 9 years of age.

N/A --A mandatory group.  
See A.9.b.

State: North Carolina

Agency*	Citation(s)	Groups Covered
	B. <u>Optional Groups Other Than the Medically Needy</u> (Continued)	
1902(a) (ii)(X) and 1902(m) (1) and (3) of the Act	<p style="text-align: center;"><u>X</u></p> <p>16. Individuals--</p> <p style="margin-left: 20px;">a. Who are 65 years of age or older or are disabled, as determined under section 1614(a)(3) of the Act. Both aged and disabled individuals are covered under this eligibility group.</p> <p style="margin-left: 20px;">b. Whose income does not exceed the income level (established at an amount up to 100 percent of the Federal income poverty level) specified in Supplement 1 to <u>ATTACHMENT 2.6-A</u> for a family of the same size; and</p> <p style="margin-left: 20px;">c. Whose resources do not exceed the maximum amount allowed under SSI; or under the State's medically needy program as specified in Supplement 2 to <u>ATTACHMENT 2.6-A</u>.</p>	

STATE PLAN UNDER TITLE XIX OF THE SOCIAL SECURITY ACT

State: North Carolina

COVERAGE AND CONDITIONS OF ELIGIBILITY

---

Citation(s)		Groups Covered
	B.	<u>Optional Groups Other Than the Medically Needy</u> (Continued)
1902(a)(47) and 1920 of the Act	<u>X</u>	17. Pregnant women who are determined by a "qualified provider" (as defined in 1920(b)(2) of the Act) based on preliminary information, to meet the highest applicable income criteria specified in this plan under <u>ATTACHMENT 2.6-A</u> and are therefore determined to presumptively eligible during a presumptive eligibility period in accordance with 1920 of the Act.

---

State/Territory: North Carolina

---

Citation	Groups Covered
	B. <u>Optional Groups Other Than the Medically Needy</u> (Continued)
1906 of the Act	18. Individuals required to enroll in cost-effective employer-based group health plans remain <u>eligible</u> for a minimum enrollment period of <u>6</u> months.
1902(a)(10)(F) and 1902(u)(1) of the Act	19. Individuals entitled to elect COBRA continuation coverage and whose income as determined under Section 1612 of the Act for purposes of the SSI program, is no more than 100 percent of the Federal poverty level, whose resources are no more than twice the SSI resource limit for an individual, and for whom the State determines that the cost of COBRA premiums is likely to be less than the Medicaid expenditures for an equivalent set of services. See Supplement 11 to Attachment 2.6-A.

STATE PLAN UNDER TITLE XIX OF THE SOCIAL SECURITY ACT

State: North Carolina

---

	<b>COVERAGE AND CONDITIONS OF ELIGIBILITY</b>
<b>Citation</b>	<b>Groups Covered</b>

---

B. Optional Coverage Other Than the Medically Needy  
 (Continued)

1902(a)(10)(A) —  
 (ii)(XIV) of  
 the Act

20. Optional Targeted Low Income  
 Children who:

- a. are not eligible for Medicaid under any other optional or mandatory eligibility group or eligible as medically needy (without spend-down liability);
- b. would not be eligible for Medicaid under the policies in the State's Medicaid plan as in effect on March 3, 1997 (other than because of the age Expansion provided for in S1902(1) (2) (D));
- c. are not covered under a group health plan or other group health insurance (as such terms are defined in S2791 of the Public Health Service Act coverage) other than under a health insurance program in operation before July 1, 1997 offered by a State which receives no Federal funds for the program;
- d. have family income at or below 200 percent of the Federal poverty level for the size family involved, as revised annually in the Federal Register; or

A percentage of the Federal poverty level, which is in excess of the "Medicaid applicable income level" (as defined in S2110 (b) (4) of the Act) but by no more than 50 percentage points.

The State covers:

\_\_\_ All children described above who are under age \_\_\_ (18, 19) with family income at or below \_\_\_ percent of the Federal poverty level.

\_\_\_ The following reasonable classification of children described above who are under age \_\_\_ \*17m 18(with family income at or below the percent of the Federal poverty level specified for the classification:

(ADD NARRATIVE DESCRIPTION(S)  
OF THE REASONABLE  
CLASSIFICATIONS(S) AND THE  
PERCENT OF THE FEDERAL POVERTY  
LEVEL USED TO ESTABLISH  
ELIGIBILITY FOR EACH  
CLASSIFICATION.)

- |                        |              |     |  |
|------------------------|--------------|-----|--|
| 1902(e)(12) of the Act | <u>  X  </u> | 21. | A child under age <u>  19  </u> (not to exceed age 19) who has been determined eligible is deemed to be eligible for a total of <u>  12  </u> months (not to exceed 12 months) regardless of changes in circumstances other than attainment of the maximum age stated above. |
| 1920A of the           | ___          | 22. | Children under age 19 who are determined Act by a qualified entity” (as defined in S1920A(b)(3)(A)) based on preliminary information, to meet the highest applicable income criteria specified in this plan.   |

The presumptive period begins on the day that the determination is made. If an application for Medicaid is filed on the child’s behalf by the last day of the month following the month in which the determination of presumptive eligibility was made, the presumptive period ends on the day that the State agency makes a determination of eligibility based on that application. If an application is not filed on the child’s behalf by the last day of the month following the month the determination of presumptive eligibility was made, the presumptive period ends on that last day.

STATE: NORTH CAROLINA

Citation	Group Covered
1902 (a) (10) (A) (ii) (XVIII) of the Act	<p data-bbox="662 470 1382 537">B. <u>Optional Coverage Other Than the Medically Needy (Continued)</u></p> <p data-bbox="662 569 922 604"><u>X</u> 23. Women who:</p> <ul style="list-style-type: none"> <li data-bbox="760 636 1471 905">a. Have been screened for breast or cervical cancer under the Centers for Disease Control and Prevention Breast and Cervical Cancer Early Detection Program established under title XV of the Public Health Service Act in accordance with the requirements of section 1504 of that Act and need treatment for breast or cervical cancer, including a pre-cancerous condition of the breast or cervix;</li> <li data-bbox="760 940 1406 1041">b. Are not otherwise covered under creditable coverage, as defined in section 2701 (c) of the Public Health Service Act;</li> <li data-bbox="760 1077 1458 1144">c. Are not eligible for Medicaid under any mandatory categorically needy eligibility group; and</li> <li data-bbox="760 1180 1157 1209">d. Have not attained age 65.</li> </ul>

TN No. 02-05  
Supersedes  
TN No. NEW

Approval Date: 03/13/02

Effective Date: 1/01/02

STATE: North Carolina

---

Citation	Group Covered
----------	---------------

---

B. Optional Coverage Other Than the Medically Needy  
(Continued)

1920B of the Act      \_\_\_ 24. Women who are determined by a "qualified entity" as defined in 1920B (b) based on preliminary information, to be a woman described in 1902 (aa) the Act related to certain breast and cervical cancer patients.

The presumptive period begins on the day that the determination is made. The period ends on the date that the State makes a determination with respect to the woman's eligibility for Medicaid, or if the woman does not apply for Medicaid (or a Medicaid application was not made on her behalf) by the last day of the month following the month in which the determination of presumptive eligibility was made, the presumptive period ends on that last day.

1902(a)(10)(A)      X 25. Independent foster care adolescents who are in foster care under the  
(ii)(XVII) of the Act      the responsibility of the North Carolina Department of Health and Human Services on their 18<sup>th</sup> birthday. Medicaid eligibility continues until age 21 without regard to income or resources.



State/Territory: North Carolina

Citation	Condition or Requirement
B. <u>Optional Groups Other Than the Medically Needy</u> (Continued)	
1902(a)(10)(A) (ii)(XIII) of the Act	<input type="checkbox"/> 23. BBA Work Incentives Eligibility Group - Individuals with a disability whose net family income is below 250 percent of the Federal poverty level for a family of the size involved and who, except for earned income, meet all criteria for receiving benefits under the SSI program. See page 12c of <u>ATTACHMENT 2.6-A.</u>
1902(a)(10)(A) (ii)(XV) of the Act	<input checked="" type="checkbox"/> 24. TWWIIA Basic Coverage Group – Individuals with a disability at least 16 but less than 65 years of age whose income and resources do not exceed a standard established by the State. See page 12d of <u>ATTACHMENT 2.6-A.</u>
1902(a)(10)(A) (ii)(XVI) of the Act	<input checked="" type="checkbox"/> 25. TWWIIA Medical Improvement Group - Employed individuals at least 16 but less than 65 years of age with a medically improved disability whose income and resources do not exceed a standard established by the State. See page 12h of <u>ATTACHMENT 2.6-A.</u>

NOTE: If the State elects to cover this group, it MUST also cover the eligibility group described in No. 24 above.



# Medicaid Eligibility

State Name: North Carolina  
Transmittal Number: NC-14-0005

OMB Control Number: 0938-1148  
Expiration date: 10/31/2014

## Eligibility Groups - Options for Coverage Individuals Eligible for Family Planning Services

S59

1902(a)(10)(A)(ii)(XXI)  
42 CFR 435.214

**Individuals Eligible for Family Planning Services** - The state elects to cover individuals who are not pregnant, and have household income at or below a standard established by the state, whose coverage is limited to family planning and related services and in accordance with provisions described at 42 CFR 435.214.

Yes  No

The state attests that it operates this eligibility group in accordance with the following provisions:

- The individual may be a male or a female.
- Income standard used for this group
- Maximum income standard

The state certifies that it has submitted and received approval for its converted income standard(s) for pregnant women to MAGI-equivalent standards and the determination of the maximum income standard to be used for this eligibility group.

**An attachment is submitted.**

The state's maximum income standard for this eligibility group is the highest of the following:

- The state's current effective income level for the Pregnant Women eligibility group (42 CFR 435.116) under the Medicaid state plan.
- The state's current effective income level for pregnant women under a Medicaid 1115 demonstration.
- The state's current effective income level for Targeted Low-Income Pregnant Women under the CHIP state plan.
- The state's current effective income level for pregnant women under a CHIP 1115 demonstration.

The amount of the maximum income standard is: % FPL

Income standard chosen

The state's income standard used for this eligibility group is:

- The maximum income standard
- Another income standard less than the maximum standard allowed.

The amount of the income standard is: % FPL

MAGI-based income methodologies are used in calculating household income. Please refer as necessary to S10MAGI-Based Income Methodologies, completed by the state.



# Medicaid Eligibility

- In determining eligibility for this group, the state uses the following household size:
  - All of the members of the family are included in the household
  - Only the applicant is included in the household
  - The state increases the household size by one
  
- In determining eligibility for this group, the state uses the following income methodology:
  - The state considers the income of the applicant and all legally responsible household members (using MAGI-based methodology).
  - The state considers only the income of the applicant.
  
- Benefits for this eligibility group are limited to family planning and related services described in the Benefit section.
  
- Presumptive Eligibility

The state makes family planning services and supplies available to individuals covered under this group when determined presumptively eligible by a qualified entity.

Yes     No

### PRA Disclosure Statement

According to the Paperwork Reduction Act of 1995, no persons are required to respond to a collection of information unless it displays a valid OMB control number. The valid OMB control number for this information collection is 0938-1148. The time required to complete this information collection is estimated to average 40 hours per response, including the time to review instructions, search existing data resources, gather the data needed, and complete and review the information collection. If you have comments concerning the accuracy of the time estimate(s) or suggestions for improving this form, please write to: CMS, 7500 Security Boulevard, Attn: PRA Reports Clearance Officer, Mail Stop C4-26-05, Baltimore, Maryland 21244-1850.

V.20140415

Revision:

CMS-PM-

ATTACHMENT 2.2-A

Page 23g

OMB No.:

State/Territory: North Carolina

---

Citation

Groups Covered

---

# PLACE HOLDER

**(CURRENT PAGE IS SUPERSEDED BY PDF “S59 PAGE 1 & PAGE 2)**

---

TN. No. 14-001

Supersedes

TN. No. 13-004

Approval Date:06-06-14

Effective Date: 01/01/2014

Revision:

CMS-PM-

ATTACHMENT 2.2-A

Page 23h

OMB NO.:

State: North Carolina

---

Citation

Groups Covered

---

In addition to family planning services, the State covers family planning-related services to such individuals during the period of presumptive eligibility.

---

TN. No. 11-040

Supersedes

TN. No. NEW

Approval: 09-21-12

Effective Date: 10/01/2011

State: North Carolina

---

Agency*	Citation(s)	Groups Covered
---------	-------------	----------------

---

C. Optional Coverage of the Medically Needy

42 CFR 435.301

This plan includes the medically needy.

No.

Yes. This plan covers:

1. Pregnant women who, except for income and/or resources, would be eligible as categorically needy under title XIX of the Act.
2. Women who, while pregnant, were eligible for and have applied for Medicaid and receive Medicaid as medically needy under the approved State plan on the date the pregnancy ends. These women continue to be eligible, as though they were pregnant, for all pregnancy-related and postpartum services under the plan for a 60-day period, beginning with the date the pregnancy ends, and any remaining days in the month in which the 60th day falls.
3. Individuals under age 18 who, but for income and/or resources, would be eligible under section 1902(a)(10)(A)(i) of the Act.

1902(e) of the Act

1902(a)(10)  
(C)(ii)(I)  
of the Act

State: North Carolina

Agency*	Citation(s)	Groups Covered
---------	-------------	----------------

C. Optional Coverage of Medically Needy  
 (Continued)

1902(e)(4) of the Act	4.	Newborn children born on or after October 1, 1984 to a woman who is eligible as medically needy and is receiving Medicaid on the date of the child's birth. The child is deemed to have applied and been found eligible for Medicaid on the date of birth and remains eligible** for one year so long as the woman remains eligible and the child is a member of the woman's household.														
42 CFR 435.308	5. <u>X</u>	<p>a. Financially eligible individuals who are not described in section C.3. above and who are under the age of</p> <table style="margin-left: 20px;"> <tr><td><u>X</u></td><td>21</td></tr> <tr><td>—</td><td>20</td></tr> <tr><td>—</td><td>19</td></tr> <tr><td>—</td><td>18</td></tr> </table> <p>b. Reasonable classifications of financially eligible individuals under the ages of 21, 20, 19, or 18 as specified below:</p> <table style="margin-left: 20px;"> <tr> <td>—</td> <td>(1) Individuals for whom public agencies are assuming full or partial financial responsibility and who are:</td> </tr> <tr> <td>—</td> <td>(a) In foster homes (and are under the age of __).</td> </tr> <tr> <td>—</td> <td>(b) In private institutions (and are under the age of __).</td> </tr> </table>	<u>X</u>	21	—	20	—	19	—	18	—	(1) Individuals for whom public agencies are assuming full or partial financial responsibility and who are:	—	(a) In foster homes (and are under the age of __).	—	(b) In private institutions (and are under the age of __).
<u>X</u>	21															
—	20															
—	19															
—	18															
—	(1) Individuals for whom public agencies are assuming full or partial financial responsibility and who are:															
—	(a) In foster homes (and are under the age of __).															
—	(b) In private institutions (and are under the age of __).															

TN No. 92-01  
 Supersedes  
 TN No. NEW

Approval Date 10-21-92

Effective Date. 1/1/92  
 HCFA ID: 7983E

\*\* or would remain eligible if she were pregnant

State: North Carolina

---

Agency*	Citation(s)	Groups Covered
---------	-------------	----------------

---

C. Optional Coverage of Medically Needy  
(Continued)

- (c) In addition to the group under b.(1)(a) and (b), individuals placed in foster homes or private institutions by private, nonprofit agencies (and are under the age of \_).
- (2) Individuals in adoptions subsidized in full or part by a public agency (who are under the age of \_\_\_).
- (3) Individuals in NFs (who are under the age of \_\_\_). NF services are provided under this plan.
- (4) In addition to the group under (b)(3), individuals in ICFs/MR (who are under the age of \_\_\_).
- (5) Individuals receiving active treatment as inpatients in psychiatric facilities or programs (who are under the age of \_\_\_). Inpatient psychiatric services for individuals under age 21 are provided under this plan.
- (6) Other defined groups (and ages), as specified in Supplement 1 of ATTACHMENT 2.2-A.



State: North Carolina

Agency*	Citation(s)	Groups Covered
	C.	<u>Optional Coverage of Medically Needy</u> (Continued)
42CFR435.310	<u>X</u> 6.	Caretaker relatives.
42CFR435.320 and 435.330	<u>X</u> 7.	Aged individuals.
42CFR435.322 and 435.330	<u>X</u> 8.	Blind individuals.
42CFR435.324 and 435.330	<u>X</u> 9.	Disabled individuals.
42CFR435.326	— 10.	Individuals who would be ineligible if they were not enrolled in an HMO. Categorically needy individuals are covered under 42 CFR 435.212 and the same rules apply to medically needy individuals.
435.340	11.	Blind and disabled individuals who: <ul style="list-style-type: none"> <li>a. Meet all current requirements for Medicaid eligibility except the blindness or disability criteria;</li> <li>b. Were eligible as medically needy in December 1973 as blind or disabled; and</li> <li>c. For each consecutive month after December 1973 continue to meet the December 1973 eligibility criteria.</li> </ul>

State: North Carolina

---

Agency*	Citation(s)	Groups Covered
1906 of the Act	C. <u>Optional Coverage of Medically Needy</u> Continued)  12. Individuals required to enroll in cost effective employer-based group health plans remain eligible for a minimum enrollment period of <u>6</u> months.	

STATE PLAN UNDER TITLE XIX OF THE SOCIAL SECURITY ACT

State: North Carolina

REQUIREMENTS RELATING TO DETERMINING ELIGIBILITY FOR MEDICARE PRESCRIPTION  
DRUG LOW-INCOME SUBSIDIES

---

Agency*	Citation(s)	Groups Covered
1935(a) and 1902(a)(66)  42 CFR 423.774 and 423.904	The agency provides for making Medicare prescription drug Low Income Subsidy determinations under Section 1935(a) of the Social Security Act.  <ol style="list-style-type: none"><li data-bbox="570 814 1466 913">1. The agency makes determinations of eligibility for premium and cost-sharing subsidies under and in accordance with section 1860D-14 of the Social Security Act;</li><li data-bbox="570 947 1466 1014">2. The agency provides for informing the Secretary of such determinations in cases in which such eligibility is established or redetermined;</li><li data-bbox="570 1050 1466 1180">3. The agency provides for screening of individuals for Medicare cost-sharing described in Section 1905(p)(3) of the Act and offering enrollment to eligible individuals under the State plan or under a waiver of the State plan.</li></ol>	

---

TN No. 05-011  
Supersedes  
TN No. New

Approval Date 10/03/05

Effective Date July 1, 2005

STATE PLAN UNDER TITLE XIX OF THE SOCIAL SECURITY ACT

State: North Carolina

REQUIREMENTS RELATING TO DETERMINING ELIGIBILITY FOR MEDICARE  
PRESCRIPTION DRUG LOW-INCOME SUBSIDIES

---

Agency	Citation (s)	Groups Covered
1935(a) and 1902(a)(66)  42 CFR 423.774 and 423.904	The agency provides for making Medicare prescription drug Low Income Subsidy determinations under Section 1935(a) of the Social Security Act.	<ol style="list-style-type: none"><li data-bbox="570 894 1455 1003">1. The agency makes determinations of eligibility for premium and cost-sharing subsidies under and in accordance with section 1860D-14 of the Social Security Act;</li><li data-bbox="570 1045 1455 1155">2. The agency provides for informing the Secretary of such determinations in cases in which such eligibility is established or redetermined;</li><li data-bbox="570 1197 1455 1333">3. The agency provides for screening of individuals for Medicare cost-sharing described in Section 1905(p)(3) of the Act and offering enrollment to eligible individuals under the State plan or under a waiver of the State plan.</li></ol>

---

TN No. 05-011  
Supersedes  
TN No. New

Approval Date 10/03/05

Effective Date July 1, 2005

Revision: HCFA-PM-91-4 (BPD)  
AUGUST 1991

SUPPLEMENT 1 TO ATTACHMENT 2.2-A  
Page 1  
OMB NO.: 0938-

STATE PLAN UNDER TITLE XIX OF THE SOCIAL SECURITY ACT

State: North Carolina

REASONABLE CLASSIFICATIONS OF INDIVIDUALS UNDER  
THE AGE OF 21, 20, 19, AND 18

---

TN No. 92-01  
Supersedes  
TN No. 89-18

Approval Date 10-21-92

Effective Date 1/1/92

HCFA ID: 7983E

Revision: HCFA-PM-91-4 (BPD) SUPPLEMENT 3 TO ATTACHMENT 2.2-A  
AUGUST 1991 Page 1  
OMB NO.: 0938-

STATE PLAN UNDER TITLE XIX OF THE SOCIAL SECURITY ACT

State: North Carolina

Method for Determining Cost Effectiveness of Caring for  
Certain Disabled Children At Home

---

TN No. 92-01

Supersedes

Approval Date 10-21-92

Effective Date 1/1/92

TN No. NEW

HCFA ID: 7983E

STATE PLAN UNDER TITLE XIX OF THE SOCIAL SECURITY ACT

State: North Carolina

ELIGIBILITY CONDITIONS AND REQUIREMENTS

---

Citation(s)	Condition or Requirement
	A. <u>General Conditions of Eligibility</u>
	Each individual covered under the plan:
42 CFR Part 435, Subpart G	1. Is financially eligible (using the methods and standards described in Parts B and C of this Attachment) to receive services.
42 CFR Part 435, Subpart F	2. Meets the applicable non-financial eligibility conditions.  a. For the categorically needy:  (i) Except as specified under items A.2.a.(ii) and (iii) below, for AFDC-related individuals, meets the non-financial eligibility conditions of the AFDC program.  (ii) For SSI-related individuals, meets the non-financial criteria of the SSI program or more restrictive SSI-related categorically needy criteria.
1902(l) of the Act	(iii) For financially eligible pregnant women, infants or children covered under sections 1902(a)(10)(A)(i)(IV), 1902(a)(10)(A)(i)(VI), 1902(a)(10)(A)(i)(VII), and 1902(a)(10)(A)(ii)(IX) of the Act, meets the non-financial criteria of section 1902(l) of the Act.
1902(m) of the Act	(iv) For financially eligible aged and disabled individuals covered under section 1902(a)(10)(A)(ii)(X) of the Act, meets the non-financial criteria of section 1902(m) of the Act.

State: North Carolina

---

Citation(s)	Condition or Requirement
	b. For the medically needy, meets the non-financial eligibility conditions of 42 CFR Part 435.
1905(p) of the Act	c. For financially eligible qualified Medicare beneficiaries covered under section 1902(a)(10)(E)(i) of the Act, meets the non-financial criteria of section 1905(p) of the Act.
1905(s) of the Act	d. For financially eligible qualified disabled and working individuals covered under section 1902(a)(10)(E)(ii) of the Act, meets the non-financial criteria of section 1905(s).
42 CFR 435.406	3. Is residing in the United States (U.S.), and <ol style="list-style-type: none"><li>Is a citizen or national of the United States;</li><li>Is a qualified alien (QA) as defined in section 431 of the Personal Responsibility and Work Opportunity Reconciliation Act of 1996 (PRWORA) as amended, and the QA's eligibility is required by section 402(b) of PRWORA as amended, and is not prohibited by section 403 of PRWORA as amended;</li><li>Is a qualified alien subject to the 5-year bar as described in section 403 of PRWORA, so that eligibility is limited to treatment of an emergency medical condition as defined in section 401 of PRWORA;</li><li>Is a non-qualified alien, so that eligibility is limited to treatment of an emergency medical condition as defined in section 401 of PRWORA;</li><li>Is a QA whose eligibility is authorized under section 402(b) of PRWORA as amended, and is not prohibited by section 403 of PRWORA as amended.</li></ol>



State: North Carolina

---

Citation	Condition or Requirement
----------	--------------------------

---

State covers all authorized QAs.

State does not cover authorized QAs.

f. State elects CHIPRA option to provide full Medicaid coverage to otherwise eligible pregnant women or children as specified below who are aliens lawfully residing in the United States; including the following:

- (1) A "Qualified alien" otherwise subject to the 5-year waiting period per section 403 of the Personal Responsibility and Work Opportunity Reconciliation Act of 1996;
- (2) A citizen of a Compact of Free Association State (i.e., Federated States of Micronesia, Republic of the Marshall Islands, and the Republic of Palau) who has been admitted to the U.S. as a non-immigrant and is permitted by the Department of Homeland Security to reside permanently or indefinitely in the U.S.;
- (3) An individual described in 8 CFR section 103.12(a)(4) who does not have a permanent residence in the country of their nationality and is in a status that permits the individual to remain in the U.S. for an indefinite period of time, pending adjustment of status. These individuals include:
  - (a) An individual currently in temporary resident status as an Amnesty beneficiary pursuant to section 210 or 245A of the Immigration and Nationality Act (INA);
  - (b) An individual currently under Temporary Protected Status pursuant to section 244 of the INA;
  - (c) A family Unity beneficiary pursuant to section 301 of Public Law 101-649 as amended by, as well as pursuant to, section 1504 of Public Law 106-554;
  - (d) An individual currently under Deferred Enforced Departure pursuant to a decision made by the President; and
  - (e) An individual who is the spouse or child of a U.S. citizen whose visa petition has been approved and who has a pending application for adjustment of status; and
- (4) An individual in non-immigrant classifications under the INA who is permitted to remain in the U.S. for an indefinite period, including the following as specified in section 101(a)(15) of the INA:
  - A parent or child of an individual with special immigrant status under section 101(a)(27) of the INA, as permitted under section 101(a)(15)(N) of the INA;
  - A Fiancé of a citizen, as permitted under section 101(a)(15)(K) of the INA;

TN No. 10-012  
Supersedes  
TN No. NEW

Approval Date: 05-25-10

Effective Date 07/01/2010

State: North Carolina

---

Citation	Condition or Requirement
----------	--------------------------

---

- A religious worker under section 101(a)(15)(R);
- An individual assisting the Department of Justice in a criminal investigation, as permitted under section 101(a)(15)(S) of the INA;
- A battered alien under section 101(a)(15)(U) (see also section 431 as amended by PRWORA); and
- An individual with a petition pending for 3 years or more, as permitted under section 101(a)(15)(V) of the INA.

X Elected for pregnant women.  
X Elected for children under age 19.

g. X The State provides assurance that for an individual whom it enrolls in Medicaid under the CHIPRA section 214 option, it has verified, at the time of the individual's initial eligibility determination and at the time of the eligibility redetermination, that the individual continues to be lawfully residing in the United States. The State must first attempt to verify this status using information provided at the time of initial application. If the State cannot do so from the information readily available, it must require the individual to provide documentation or further evidence to verify satisfactory immigration status in the same manner as it would for anyone else claiming satisfactory immigration status under section 1137(d) of the Act.

State: North Carolina

Citation	Condition or Requirement
	d. Is an alien granted lawful temporary resident status under section 210 of the Immigration and Nationality Act not within the scope of c. above (coverage must be restricted to certain emergency services during the five-year period beginning on the date the alien was granted such status); or
	e. Is an alien who is not lawfully admitted for permanent residence or otherwise permanently residing in the United States under color of law (coverage must be restricted to certain emergency services).
42 CFR 435.403 1902(b) of the Act	4. Is a resident of the State, regardless of whether or not the individual maintains the residence permanently or maintains it at a fixed address.
	<u>X</u> State has interstate residency agreement with the following States:  Georgia
	<u>    </u> State has open agreement(s).
	<u>    </u> Not applicable; no residency requirement.

State/Territory: North Carolina

---

Citation	Condition or Requirement
42 CFR 435.1008	5. a. Is not an inmate of a public institution. Public institutions do not include medical institutions, intermediate care facilities, or publicly operated community residences that serve no more than 16 residents, or certain child care institutions.
42 CFR 435.1008 1905(a) of the Act	b. Is not a patient under age 65 in an institution for mental diseases except as an inpatient under age 22 receiving active treatment in an accredited psychiatric facility or program.  ____ Not applicable with respect to individuals under age 22 in psychiatric facilities or programs. Such services are not provided under the plan.
42 CFR 433.145 1912 of the Act	6. Is required, as a condition of eligibility, to assign his or her own rights, or the rights of any other person who is eligible for Medicaid and on whose behalf the individual has legal authority to execute an assignment, to medical support and payments for medical care from any third party. (Medical support is defined as support specified as being for medical care by a court or administrative order.)

---

TN No. 92-27  
Supersedes  
TN No. 92-01

Approval Date 1-31-94

Effective Date 7/1/92

HCFA ID: 7985E

State /Territory: North Carolina

---

Citation	Condition or Requirement
42 CFR 435.910	<p>An applicant or recipient must also cooperate in establishing the paternity of any eligible child and in obtaining medical support and payments for himself or herself and any other person who is eligible for Medicaid and on whose behalf the individual can make an assignment; except that individuals described in §1902(1)(1)(A) of the Social Security Act (pregnant women and women in the post-partum period) are exempt from these requirements involving paternity and obtaining support. Any individual may be exempt from the cooperation requirements by demonstrating good cause for refusing to cooperate.</p> <p>An applicant or recipient must also cooperate in identifying any third party who may be liable to pay for care that is covered under the State plan and providing information to assist in pursuing these third parties. Any individual may be exempt from the cooperation requirements by demonstrating good cause for refusing to cooperate.</p> <p><u>XX/</u> Assignment of rights is automatic because of State law.</p> <p>7. Is required, as a condition of eligibility, to furnish his/her social security account number (or numbers, if he/she has more than one number).</p>

---

TN No. 92-27  
Supersedes  
TN No. NEW

Approval Date 1-31-94 Effective Date 7/1/92

HCFA ID: 7985E

State: North Carolina

---

Citation	Condition or Requirement
1902(c)(2)	8. Is not required to apply for AFDC benefits under title IV-A as a condition of applying for, or receiving, Medicaid if the individual is a pregnant woman, infant, or child that the State elects to cover under sections 1902(a)(10)(A)(i)(IV) and 1902(a)(10)(A)(ii)(IX) of the Act.
1902(e)(10)(A) and (B) of the Act	9. Is not required, as an individual child or pregnant woman; to meet requirements under section 402(a)(43) of the Act to be in certain living arrangements (Prior to terminating AFDC individuals who do not meet such requirements under a State's AFDC plan, the agency determines if they are otherwise eligible under the State's Medicaid plan.)

Revision: HCFA-PM-91-8 (MB)  
October 1991

ATTACHMENT 2.6-A  
Page 3c  
OMB No.: 0938-

State/Territory: North Carolina

---

Citation	Condition or Requirement
1906 of the Act	10. Is required to apply for enrollment in an employer-based cost-effective group health plan, if such plan is available to the individual. Enrollment is a condition of eligibility except for the individual who is unable to enroll on his/her own behalf (failure of a parent to enroll a child does not affect a child's eligibility).

---

TN No. 92-27  
Supersedes  
TN No. NEW

Approval Date 1-31-94

Effective Date 7/1/92

HCFA ID: 7985E

State: North Carolina

---

Citation	Condition or Requirement
	B. Post eligibility Treatment of Institutionalized Individuals' Incomes
	1. The following items are not considered in the post eligibility process:
1902(o)of the Act	a. SSI and SSP benefits paid under §1611 (e)(1)(E) and (G) of the Act to individuals who receive care in a hospital, nursing home, SNF, or ICF.
Bondi v Sullivan (SSI)	b. Austrian Reparation Payments (pension (reparation) payments made under §500 - 506 of the Austrian General Social Insurance Act). Applies only if State follows SSI program rules with respect to the payments.
1902(r)(1) of the Act	c. German Reparations Payments (reparation payments made by the Federal Republic of Germany).
105/206 of P.L. 100-383	d. Japanese and Aleutian Restitution Payments.
1.(a) of P.L. 103-286	e. Netherlands Reparation Payments based on Nazi, but not Japanese, persecution (during World War II).
10405 of P.L. 101-239	f. Payments from the Agent Orange Settlement Fund or any other fund established pursuant to the settlement in the In re Agent Orange product liability litigation, M.D.L. No. 381 (E.D.N.Y.)
6(h)(2) of P.L. 101-426	g. Radiation Exposure Compensation.
12005 of P. L. 103-66	h. VA pensions limited to \$90 per month under 38 U.S.C. 5503.



State: North Carolina

---

Citation	Condition or Requirement
1924 of the Act 435.725 435.733 435.832	<p>2. The following monthly amounts for personal needs are deducted from total monthly income in the application of an institutionalized individual's or couple's income to the cost of institutionalized care:</p> <p>Personal Needs Allowance (PNA) of not less than \$30 For Individuals and \$60 For Couples For All Institutionalized Persons.</p> <p>a. Aged, blind, disabled: Individuals \$ <u>30</u> Couples \$ <u>60</u></p> <p>For the following persons with greater need:</p> <p>Supplement 12 to <u>Attachment 2.6-A</u> describes the greater need; describes the basis or formula for determining the deductible amount when a specific amount is not listed above; lists the criteria to be met; and, where appropriate, identifies the organizational unit which determines that a criterion is met.</p> <p>b. AFDC related: Children \$ <u>30</u> Adults \$ <u>30</u></p> <p>For the following persons with greater need:</p> <p>Supplement 12 to <u>Attachment 2.6-A</u> describes the greater need; describes the basis or formula for determining the deductible amount when a specific amount is not listed above; lists the criteria to be met; and, where appropriate, identifies the organizational unit which determines that a criterion is met.</p> <p>c. Individual under age 21 covered in the plan as specified in Item B. 7. of <u>Attachment 2.2-A.</u> <u>\$30</u></p>

State: North Carolina

---

Citation	Condition or Requirement
1924 of the Act	<p>For the following persons with greater need:</p> <p>Supplement 12 to <u>Attachment 2.6-A</u> describes the greater need; describes the basis or formula for determining the deductible amount when a specific amount is not listed above; lists the criteria to be met; and, where appropriate, identifies the organizational unit which determines that a criterion is met.</p> <p>3. In addition to the amounts under item 2. , the following monthly amounts are deducted from the remaining income of an institutionalized individual with a community spouse:</p> <p>a. The monthly income allowance for the community spouse, calculated using the formula in §1924(d)(2), is the amount by which the maintenance needs standard exceeds the community spouse's income. The maintenance needs standard cannot exceed the maximum prescribed in §1924 (d)(3)(C). The maintenance needs standard consists of a poverty level component plus an excess shelter allowance.</p> <p><u>X</u> The poverty level component is calculated using the applicable percentage (set out §1924(d)(3)(B) of the Act) of the official poverty level.</p> <p><u>      </u> The poverty level component is calculated using a percentage greater than the applicable percentage, equal to <u>      </u>%, of the official poverty level (still subject to maximum maintenance needs standard).</p> <p><u>      </u> The maintenance needs standard for all community spouses is set at the maximum permitted by §1924(d)(3)(C).</p> <p>Except that, when applicable, the State will set the community spouse's monthly income allowance at the amount by which exceptional maintenance needs, established at a fair hearing, exceed the community spouse's income, or at the amount of any court ordered support.</p>

State: North Carolina

---

Citation	Condition or Requirement
----------	--------------------------

---

In determining any excess shelter allowance, utility expenses are calculated using:

X the standard utility allowance under §5(e) of the Food Stamp Act of 1977; or

\_\_\_ the actual unreimbursable amount of the community spouse's utility expenses less any portion of such amount included in condominium or cooperative charges.

b. The monthly income allowance for other dependent family members living with the community spouse is:

X one-third of the amount by which the poverty level component (calculated under §1924(d)(3)(A)(i) of the Act, using the applicable percentage specified in §1924(d)(3)(B)) exceeds the dependent family member's monthly income.

\_\_\_ a greater amount calculated as follows:

The following definition is used in lieu of the definition provided by the Secretary to determine the dependency of family members under §1924(d)(1):

c. Amounts for health care expenses described below that are incurred by and for the institutionalized individual and are not subject to payments by a third party:

(i) Medicaid, Medicare, and other health insurance premiums, deductibles, or coinsurance charges, or copayments.

(ii) Necessary medical or remedial care recognized under State law but not covered under the State plan. (Reasonable limits on amounts are described in Supplement 3 to ATTACHMENT 2.6-A.)

State: North Carolina

Citation	Condition or Requirement
435.725 above, 435.733 435.832	<p>4. In addition to any amounts deductible under the items above, the following monthly amounts are deducted from the remaining monthly income of an institutionalized individual or an institutionalized couple:</p> <p>a. An amount for the maintenance needs of each member of a family living in the institutionalized individual's home with no community spouse living in the home. The amount must be based on a reasonable assessment of need but must not exceed the higher of the</p> <ul style="list-style-type: none"><li><input type="radio"/> AFDC level; or</li><li><input type="radio"/> Medically needy level:</li></ul> <p>(Check one)</p> <p><input type="checkbox"/> AFDC levels in Supplement 1 <input checked="" type="checkbox"/> Medically needy level in Supplement 1 <input type="checkbox"/> Other: \$ _____</p> <p>b. Amounts for health care expenses described below that have not been deducted under 3.c. above (i.e., for an institutionalized individual with a community spouse), are incurred by and for the institutionalized individual or institutionalized couple, and are not subject to the payment by a third party:</p> <ul style="list-style-type: none"><li>(i) Medicaid, Medicare, and other health insurance premiums, deductibles, or coinsurance charges, or copayments.</li><li>(ii) Necessary medical or remedial care recognized under State law but not covered under the State plan. (Reasonable limits on amount are described in Supplement 3 to ATTACHMENT 2.6-A.)</li></ul>
435.725 435.733 435.832	<p>5. At the option of the State, as specified below, the following is deducted from any remaining monthly income of an institutionalized individual or an institutionalized couple:</p> <p>A monthly amount for the maintenance of the home of the individual or couple for not longer than 6 months if a physician has certified that the individual, or one member of the institutionalized couple, is likely to return to the home within that period:</p> <p><input type="checkbox"/> No. <input checked="" type="checkbox"/> Yes (the applicable amount is shown on page 5a.)</p>

State: North Carolina

---

Citation	Condition or Requirement
<u>X</u>	Amount for maintenance of home is: \$ <u>The Medically Needy</u> Income Limit - see Supplement 1 to this attachment.
___	Amount for maintenance of home is the actual maintenance costs not to exceed \$ _____.
<u>X</u>	Amount for maintenance of home is deductible when countable income is determined under §1924(d)(1) of the Act only if the individuals' home and the community spouse's home are different.
___	Amount for maintenance of home is not deductible when countable income is determined under §1924 (d)(1) of the Act.

STATE North Carolina

---

Citation

Condition or Requirement

---

	2.	A fixed standard greater than the amount which would be used if the formula described in section 1924(d)(1)(C) were used. The standard used is \$_____.
	<u>X</u> c.	The standards described above are used for individuals receiving home and community based waiver services in lieu of services provided in a medical and remedial care institution.
	d.	Definition of Dependency  The definition of dependency below is used to define dependent children, parents and siblings for purposes of deducting allowances under Section 1924. See attached page 5 (b.1.)
435.711 435.721 435.831	C.	<u>Financial Eligibility - Categorically and Medically Needy and Qualified Medicare Beneficiaries and Qualified Disabled Working Individuals</u>

Except as provided under section 1924 of the Act the policies reflected in C. items 1-5 apply. See Supplement 13 for additional policies relative to Section 1924.

1902(l) or the Act, P.L. 99-643  
(Section 3(b))

1. Income disregards --  
Categorically and  
Medically Needy and Qualified  
Medicare Beneficiaries and  
Qualified Disabled Working  
Individuals

---

TN. No. 91-42

Supersedes

TN. No. 89-17

Approval Date 11-5-91

Effective Date: 7/1/91

Dependency is established if a person may be claimed as a dependent for federal or state tax purposes.

TN. No. 89-17  
Supersedes  
TN. No. NEW

Approval Date: APR 26 1990 Effective Date: 10/1/89

STATE PLAN UNDER TITLE XIX OF THE SOCIAL SECURITY ACT

State:North Carolina

ELIGIBILITY CONDITIONS AND REQUIREMENTS

---

Citation(s)	Condition or Requirement
42 CFR 435.711 435.721, 435.831	<p>C. <u>Financial Eligibility</u></p> <p>For individuals who are AFDC or SSI recipients, the income and resource levels and methods for determining countable income and resources of the AFDC and SSI program apply, unless the plan provides for more restrictive levels and methods than SSI for SSI recipients under section 1902(f) of the Act, or more liberal methods under section 1902(r)(2) of the Act, as specified below.</p> <p>For individuals who are not AFDC or SSI recipients in a non-section 1902(f) State and those who are deemed to be cash assistance recipients, the financial eligibility requirements specified in this section C apply.</p> <p><u>Supplement 1 to ATTACHMENT 2.6-A</u> specifies the income levels for mandatory and optional categorically needy groups of individuals, including individuals with incomes related to the Federal income poverty level-pregnant women and infants or children covered under sections 1902(a)(10)(A)(i)(IV), 1902(a)(10)(A)(i)(VI), 1902(a)(10)(A)(i)(VII), and 1902(a)(10)(A)(ii)(IX) of the Act and aged and disabled individuals covered under section 1902(a)(10)(A)(ii)(X) of the Act--and for mandatory groups of qualified Medicare beneficiaries covered under section 1902(a)(10)(E)(i) of the Act.</p>

TN No. 92-01  
Supersedes  
TN No. 89-15

Approval Date 10-21-92

Effective Date 1-1-92



State: North Carolina

---

Citation	Condition or Requirement
<u>X</u>	<u>Supplement 2 to ATTACHMENT 2.6-A</u> specifies the resource levels for mandatory and optional categorically needy poverty level related groups, and for medically needy groups.
_____	<u>Supplement 7 to ATTACHMENT 2.6-A</u> specifies the income levels for categorically needy aged, blind and disabled persons who are covered under requirements more restrictive than SSI.
_____	<u>Supplement 4 to ATTACHMENT 2.6-A</u> specifies the methods for determining income eligibility used by States that have more restrictive methods than SSI, permitted under section 1902(f) of the Act.
_____	<u>Supplement 5 to ATTACHMENT 2.6-A</u> specifies the methods for determining resource eligibility used by States that have more restrictive methods than SSI, permitted under section 1902(f) of the Act.
<u>X</u>	<u>Supplement 8a to ATTACHMENT 2.6-A</u> specifies the methods for determining income eligibility used by States that are more liberal than the methods of the cash assistance programs, permitted under section 1902(r)(2) of the Act.
<u>X</u>	<u>Supplement 8b to ATTACHMENT 2.6-A</u> specifies the methods for determining resource eligibility used by States that are more liberal than the methods of the cash assistance programs, permitted under section 1902(r)(2) of the Act.

---

TN No. 94-36  
Supersedes  
TN No. 92-01

Approval Date 5-18-95

Effective Date 1-1-95

HCFA ID: 7985E

STATE UNDER TITLE XIX OF THE SOCIAL SECURITY ACT

State: North Carolina

ELIGIBILITY CONDITIONS AND REQUIREMENTS

---

Citation(s)	Condition or Requirement
1902(r)(2) of the Act	<p>1. <u>Methods of Determining Income</u></p> <p>a. <u>AFDC-related individuals (except for poverty level related pregnant women, infants, and children).</u></p> <p>(1) In determining countable income for AFDC-related individuals, the following methods are used:</p> <p style="padding-left: 40px;">___ (a) The methods under the State's approved AFDC plan only; or</p> <p style="padding-left: 40px;"><u>x</u> (b) The methods under the State's approved AFDC plan and/or any more liberal methods described in <u>Supplement 8a to ATTACHMENT 2.6-A.</u></p> <p>(2) In determining relative financial responsibility, the agency considers only the income of spouses living in the same household as available to spouses and the income of parents as available to children living with parents until the children become 21.</p>
1902(e)(6) the Act	<p>(3) Agency continues to treat women eligible under the provisions of sections 1902(a)(10) of the Act as eligible, without regard to any changes in income of the family of which she is a member, for the 60-day period after her pregnancy ends and any remaining days in the month in which the 60th day falls.</p>

STATE PLAN UNDER TITLE XIX OF THE SOCIAL SECURITY ACT

State: North Carolina

ELIGIBILITY CONDITIONS AND REQUIREMENTS

Citation(s)	Condition or Requirement
42 CFR 435.721 435.831, and 1902(m)(1)(B)(m)(4) and 1902(r)(2) to the of the Act	b. <u>Aged individuals</u> . In determining countable income for aged individuals, including aged individuals with incomes up Federal poverty level described in section 1902(m)(1) of the Act, the following methods are used:  <u>      </u> The methods of the SSI program only.  <u>  X  </u> The methods of the SSI program and/or any more liberal methods described in <u>Supplement 8a to ATTACHMENT</u> <u>2.6-A.</u>

---

TN No.: 07-007

Supersedes

Approval Date: 10/30/07

Effective Date: 07/01/07

TN No.: 94-36

State: North Carolina

---

Citation	Condition or Requirement
_____	For individuals other than optional State supplement recipients, more restrictive methods than SSI, applied under the provisions of section 1902(f) of the Act, as specified in <u>Supplement 4 to ATTACHMENT 2.6-A</u> and any more liberal methods described in <u>Supplement 8a to ATTACHMENT 2.6-A</u> .
_____	For institutional couples, the methods specified under section 1611(e)(5) of the Act.
_____	For optional State supplement recipients under S435.230, income methods more liberal than SSI, as specified in <u>Supplement 4 to ATTACHMENT 2.6-A</u> .
_____	For optional State supplement recipients in section 1902(f) States and SSI criteria States without section 1616 or 1634 agreements--
_____	SSI methods only.
_____	SSI methods and/or any more liberal methods than SSI described in <u>Supplement 8a to ATTACHMENT 2.6-A</u> .
_____	Methods more restrictive and/or more liberal than SSI. More restrictive methods are described in <u>Supplement 4 to ATTACHMENT 2.6-A</u> and more liberal methods are described in <u>Supplement 8a to ATTACHMENT 2.6-A</u> .
	In determining relative financial responsibility, the agency considers only the income of spouses living in the same household as available to spouses.

---

TN No. 94-36  
Supersedes  
TN No. 92-01

Approval Date 5-18-95

Effective Date 1-1-95

State: North Carolina

Citation	Condition or Requirement
42 CFR 435.721 and 435.831 1902(m)(1)(B), (m)(4), and 1902 (r) (2). program only. of the Act	c. <u>Blind individuals.</u> In determining countable income for blind individuals, the following methods are used:
	_____ The methods of the SSI
	<u>X</u> SSI methods and/or any more liberal methods described in <u>Supplement 8a to ATTACHMENT 2.6-A.</u>
	_____ For individuals other than optional State supplement recipients, more restrictive methods than SSI, applied under the provisions of section 1902(f) of the Act, as specified in <u>Supplement 4 to ATTACHMENT 2.6-A,</u> and any more liberal methods described in <u>Supplement 8a to ATTACHMENT 2.6-A.</u>
	_____ For institutional couples, the methods specified under section 1611(e)(5) of the Act.
	_____ For optional State supplement recipients under S435.230, income methods more liberal than SSI, as specified in <u>Supplement 4 to ATTACHMENT 2.6-A.</u>
	_____ For optional State supplement recipients in section 1902(f) States and SSI criteria States without section 1616 or 1634 agreements-- SSI methods only.
	_____ SSI methods and/or any more liberal methods than SSI described in <u>Supplement 8a to ATTACHMENT 2.6-A.</u>
	_____ Methods more restrictive and/ or more liberal than SSI. More restrictive methods are described in <u>Supplement 4 to ATTACHMENT 2.6-A</u> and more liberal methods are described in <u>Supplement 8a to ATTACHMENT 2.6-A.</u>

TN No.: 07-007  
Supersedes  
07/01/07  
TN No.: 94-36

Approval Date: 10/30/07      Effective Date:

State: North Carolina

---

Citation

Condition or Requirement

---

42 CFR 435.721,  
and 435.831  
1902(m)(1)(B),  
with  
(m)(4), and  
level  
1902(r)(2)  
of the Act

d. Disabled individuals. In determining countable income of disabled individuals, including individuals incomes up to the Federal poverty level described in section 1902(m) of the Act the following methods are used:

X The methods of the SSI program.

X SSI methods and/or any more liberal methods described in Supplement 8a to ATTACHMENT 2.6-A.

— For institutional couples: the methods specified under section 1611(e)(5) of the Act.

— For optional State supplement recipients under 435.230: income methods more liberal than SSI, as specified in Supplement 4 to ATTACHMENT 2.6-A.

— For individuals other than optional State supplement recipients (except aged and disable individuals described in section 1903(m)(1) of the Act): more restrictive methods than SSI, applied under the provisions of section 1902 (f) of the Act, as specified in Supplement 4 to ATTACHMENT 2.6-A; and any more liberal methods described in Supplement 8a to ATTACHMENT 2.6-A

TN No.: 94-36

Revision: HCFA-PM-91-4 (BPD)  
AUGUST 1991

ATTACHMENT 2.6-A  
Page 11  
OMB No.: 0938-

State: North Carolina

---

Citation	Condition or Requirement
_____	For optional State supplement recipients -in section 1902(f) States and SSI criteria States without section 1616 or 1634 agreements-
_____	SSI methods only.
_____	SSI methods and/or any more liberal methods than SSI described in <u>Supplement 8a to ATTACHMENT 2.6-A.</u>
_____	Methods more restrictive than SSI, except for aged and disabled individuals described in section 1902(m)(1) of the Act. More restrictive methods are described in <u>Supplement 4 to ATTACHMENT 2.6-A</u> and more liberal methods are specified in <u>Supplement 8a to ATTACHMENT 2.6-A.</u>

In determining relative financial responsibility, the agency considers only the income of spouses living in the same household as available to spouses and the income of parents as available to children living with parents until the children become 21.

---

TN No. 94-36  
Supersedes  
TN No. 92-01

Approval Date 5-18-95

Effective Date 1-1-95

HCFA ID: 7985E

STATE PLAN UNDER TITLE XIX OF THE SOCIAL SECURITY ACT

State: North Carolina

ELIGIBILITY CONDITIONS AND REQUIREMENTS

---

Citation(s)	Condition or Requirement
1902(1)(3)(E) and 1902(r)(2) of the Act	<p>e. <u>Poverty level pregnant women, infants, and children.</u> For pregnant women and infants For children covered under the provisions of sections 1902(a)(10)(A) (i)(IV), (VI), and (VII), and 1902(a) (10)(A)(ii)(IX) of the Act--</p> <p>(1) The following methods are used in determining countable income:</p> <ul style="list-style-type: none"><li>— The methods of the State's approved AFDC plan.</li><li>— The methods of the approved title IV-E plan.</li><li><u>X</u> The methods of the approved AFDC State plan and/or any more liberal methods described in <u>Supplement 8a to ATTACHMENT 2.6-A.</u></li><li>— The methods of the approved title IV-E plan and/or any more liberal methods described in <u>Supplement 8a to ATTACHMENT 2.6-A.</u></li></ul>



STATE PLAN UNDER TITLE XIX OF THE SOCIAL SECURITY ACT

State: North Carolina

ELIGIBILITY CONDITIONS AND REQUIREMENTS

---

Citation(s)	Condition or Requirement
	(2) In determining relative financial responsibility, the agency considers only the income of spouses living in the same household as available to spouses and the income of parents as available to children living with parents until the children become 21.
1902(e)(6) of the Act	(3) The agency continues to treat women eligible under the provisions of sections 1902(a)(10) of the Act as eligible, without regard to any changes in income of the family of which she is a member, for the 60-day period after her pregnancy ends and any remaining days in the month in which the 60th day falls.
1905(p)(1), 1902(m)(4), and 1902(r)(2) of the Act	f. <u>Qualified Medicare beneficiaries.</u> In determining countable income for qualified Medicare beneficiaries covered under section 1902(a)(10)(E)(i) of the Act, the following methods are used:  <input checked="" type="checkbox"/> The methods of the SSI program only.  <input type="checkbox"/> SSI methods and/or any more liberal methods than SSI described in <u>Supplement 8a to ATTACHMENT 2.6-A.</u>  <input type="checkbox"/> For Institutional couples, the methods specified under section 1611(e)(5) of the Act.

State: North Carolina

---

Citation	Condition or Requirement
----------	--------------------------

---

If an individual receives a title II benefit, any amounts attributable to the most recent increase in the monthly insurance benefit as a result of a title II COLA is not counted as income during a "transition period" beginning with January, when the title II benefit for December is received, and ending with the last day of the month following the month of publication of the revised annual Federal poverty level.

For individuals with title II income, the revised poverty levels are not effective until the first day of the month following the end of the transition period.

For individuals not receiving title II income, the revised poverty levels are effective no later than the date of publication.

1905(s) of the Act	g.	(1)	<u>Qualified disabled and working individuals.</u>
--------------------	----	-----	--

In determining countable income for qualified disabled and working individuals covered under 1902(a)(10)(E)(ii) of the Act, the methods of the SSI program are used.

1905(p) of the Act		(2)	<u>Specified low-income Medicare beneficiaries.</u>
--------------------	--	-----	---

In determining countable income for specified low-income Medicare beneficiaries covered under 1902(a)(10)(E)(iii) of the Act, the same method as in f. is used.

---

TN No. 93-03

Supersedes

TN No. 92-01

\*U.S. G.P.O.:1993-342-239:80032

Approval Date 4/20/93

Effective Date 1/1/93

State/Territory: North Carolina

---

Citation	Condition or Requirement
1902(u) of the Act	<p data-bbox="472 533 992 558">h. <u>COBRA Continuation Beneficiaries</u></p> <p data-bbox="667 600 1357 663">In determining countable income for COBRA continuation beneficiaries, the following disregards are applied:</p> <ul data-bbox="570 701 1357 898" style="list-style-type: none"><li data-bbox="570 701 1078 726">— The disregards of the SSI program;</li><li data-bbox="570 768 1357 898">— The agency uses methodologies for treatment of income more restrictive than the SSI program. These more restrictive methodologies are described in Supplement 4 to Attachment 2.6-A.</li></ul> <p data-bbox="667 940 1409 1102">NOTE: For COBRA continuation beneficiaries specified at 1902(u)(4), costs incurred from medical care or for any other type of remedial care shall not be taken into account in determining income, except as provided in section 1612(b)(4)(B)(ii).</p>

State/Territory: North Carolina

---

Citation	Condition or Requirement
1902(a)(10)(A)(ii) (XIII) of the Act	<p data-bbox="570 632 1192 659">(i) <u>Working Individuals With Disabilities -BBA</u></p> <p data-bbox="667 699 1365 798">In determining countable income and resources for working individuals with disabilities under BBA, the following methodologies are applied:</p> <ul style="list-style-type: none"> <li data-bbox="667 835 1214 863">_____ The methodologies of the SSI program.</li> <li data-bbox="667 903 1427 1066">_____ The agency uses methodologies for treatment of income and resources more restrictive than the SSI program. These more restrictive methodologies are described in Supplement 4 (income) and Supplement 5 (resources) to <u>ATTACHMENT 2.6-A</u>.</li> <li data-bbox="667 1106 1427 1270">_____ The agency uses more liberal income and/or resource than the SSI program. More liberal methodologies are described in Supplement 8a to attachment 2.6-A. More liberal resource methodologies are described in <u>Supplement 8b to ATTACHMENT 2.6-A</u>.</li> </ul>

Revision:

ATTACHMENT 2.6-A  
Page 12d  
OMB No.:

State/Territory: North Carolina

Citation	Condition or Requirement
----------	--------------------------

1902(a)(10)(A)  
(ii)(XV) of the Act

(ii) Working Individuals with Disabilities - Basic Coverage Group - TWWIIA

In determining financial eligibility for working individuals with disabilities under this provision. The following standards and methodologies are applied:

     The agency does not apply any income or resource standard.

NOTE: If the above option is chosen, no further eligibility-related options should be elected.

  X   The agency applies the following income and/or resource standard(s):

The total countable income standard is unlimited. However, those with total countable income equal to or greater than 450% of the federal poverty level must pay a 100% premium (see page 12o).

The countable unearned income standard equals the SSI federal benefit rate. (See Supplement 8a to Attachment 2.6-A for unearned income disregard).

Resource standard equals the minimum community spouse resource allowance as defined in §1924(f)(2)(A)(i) of the Act, subject to adjustment under §1924(g) of the Act.

Revision:

ATTACHMENT 2.6-A

Page 12e

OMB No.:

State/Territory: North Carolina

---

Citation	Condition or Requirement
1902(a)(10)(A) (ii)(XV) of the Act (cont.)	<p data-bbox="570 533 841 560"><u>Income Methodologies</u></p> <p data-bbox="667 600 1421 661">In determining whether an individual meets the income standard described above, the agency uses the following methodologies.</p> <p data-bbox="667 701 1317 728">_____ The income methodologies of the SSI program.</p> <p data-bbox="667 804 1421 932">_____ The agency uses methodologies for treatment of income that are more restrictive than the SSI program. These more restrictive methodologies are described in <u>Supplement 4 to ATTACHMENT 2.6-A</u>.</p> <p data-bbox="667 972 1377 1100"><u>X</u> The agency uses more liberal income methodologies than the SSI program. More liberal income methodologies are described in <u>Supplement 8a to ATTACHMENT 2.6-A</u>.</p>

---

TN No: 08-017

Supersedes

TN No: NEW

Approval Date: 03/16/09

Effective Date: 11/01/2008

CMS ID:

State/Territory: North Carolina

---

Citation	Condition or Requirement
----------	--------------------------

---

1902(a)(10)(A)  
(ii)(XV) of the Act (cont.)

Resource Methodologies

In determining whether the individual meets the resource standard described above, the agency uses the following methodologies.

Unless one of the following items is checked, the agency, under the authority of 1902(r)(2) of the Act, disregards all funds held in retirement funds and accounts, including private retirement accounts such as IRAs and other individual accounts, and employer-sponsored retirement plans such as 401(k) plans, Keogh plans, and employer pension plans. Any disregard involving retirement accounts is separately described in Supplement 8b to ATTACHMENT 2.6-A.

\_\_\_\_\_ The agency disregards funds held in employer-sponsored retirement plans, but not private retirement plans.

\_\_\_\_\_ The agency disregards funds in retirement accounts in a manner other than those described above. The agency's disregards are specified in Supplement 8b to ATTACHMENT 2.6-A.

Revision:

ATTACHMENT 2.6-A

Page 12g

OMB No.:

State/Territory: North Carolina

Citation	Condition or Requirement
1902(a)(10)(A) (ii)(XV) of the Act (cont.)	<p data-bbox="667 531 1193 594"><u>  X  </u> The agency does not disregard funds in retirement accounts.</p> <p data-bbox="667 632 1429 800"><u>  X  </u> The agency uses resource methodologies in addition to any indicated above that are more liberal than those used by the SSI program. More liberal resource methodologies are described in <u>Supplement 8b to ATTACHMENT 2.6-A.</u></p> <p data-bbox="667 837 1409 900">_____ The agency uses the resource methodologies of the SSI Program.</p> <p data-bbox="667 938 1422 1068">_____ The agency uses methodologies for treatment of resources that are more restrictive than the SSI program. These more restrictive methodologies are described in <u>Supplement 5 to ATTACHMENT 2.6-A.</u></p>

TN No: 08-017  
Supersedes  
TN No: NEW

Approval Date: 03/16/09

Effective Date: 11/01/2008

CMS ID:



State/Territory: North Carolina

---

Citation	Condition or Requirement
----------	--------------------------

---

1902(a)(10)(A)  
(ii)(XVI) of the Act

(iii) Working Individuals with Disabilities -  
Employed Medically Improved Individuals - TWWIIA

In determining financial eligibility for employed medically improved individuals under this provision, the following standards and methodologies are applied:

The agency does not apply any income or resource standard.

NOTE: If the above option is chosen, no further eligibility-related options should be elected.

The agency applies the following income and/or resource standard(s):

The total countable income standard is unlimited. However, those with countable income equal to or greater than 450% of the federal poverty level must pay a 100% premium (see page 12o).

The countable unearned income standard equals the SSI federal benefit rate. (See Supplement 8a to Attachment 2.6-A for unearned income disregard).

Resource standard equals the minimum community spouse resource allowance as defined in §1924(f)(2)(A)(i) of the Act, subject to adjustment under §1924(g) of the Act.

---

TN No. 13-045  
Supersedes  
TN No. 08-017

Approval Date: 08-08-14

Effective Date 10/01/2013

CMS ID:

Revision:

ATTACHMENT 2.6-A

Page 12i

OMB No.:

State/Territory: North Carolina

---

Citation	Condition or Requirement
1902(a)(10)(A) (ii)(XVI) of the Act (cont.)	<p data-bbox="570 600 841 630"><u>Income Methodologies</u></p> <p data-bbox="667 667 1421 730">In determining whether an individual meets the income standard described above, the agency uses the following methodologies.</p> <p data-bbox="667 768 1317 798">___ The income methodologies of the SSI program.</p> <p data-bbox="667 869 1421 1003">___ The agency uses methodologies for treatment of income that are more restrictive than the SSI program. These more restrictive methodologies are described in <u>Supplement 4 to ATTACHMENT 2.6-A.</u></p> <p data-bbox="667 1041 1377 1169"><u>X</u> The agency uses more liberal income methodologies than the SSI program. More liberal income methodologies are described in <u>Supplement 8a to ATTACHMENT 2.6-A.</u></p>

---

TN No: 08-017

Supersedes

TN No: NEW

Approval Date: 03/16/09

Effective Date : 11/01/2008

CMS ID:

State/Territory: North Carolina

---

Citation	Condition or Requirement
----------	--------------------------

---

1902(a)(10)(A)  
(ii)(XVI) of the Act (cont.)

Resource Methodologies

In determining whether the individual meets the resource standard described above, the agency uses the following methodologies.

Unless one of the following items are checked, the agency, under the authority of 1902(r)(2) of the Act, disregards all funds held in retirement funds and accounts, including private retirement accounts such as IRAs and other individual accounts, and employer-sponsored retirement plans such as 401(k) plans, Keogh plans, and employer pension plans. Any disregard involving retirement accounts is separately described in Supplement 8b to ATTACHMENT 2.6-A.

\_\_\_\_\_ The agency disregards funds held in employer-sponsored retirement plans, but not private retirement plans.

\_\_\_\_\_ The agency disregards funds in retirement accounts in a manner other than those described above. The agency's disregards are specified in Supplement 8b to ATTACHMENT 2.6-A.

Revision:

ATTACHMENT 2.6-A

Page 12k

OMB No.:

State/Territory: North Carolina

Citation	Condition or Requirement
1902(a)(10)(A) (ii)(XVI) of the Act (cont.)	<u>X</u> The agency does not disregard funds in retirement accounts.
	<u>X</u> The agency uses resource methodologies in addition to any indicated above that are more liberal than those used by the SSI program. More liberal resource methodologies are described in <u>Supplement 8b to ATTACHMENT 2.6-A</u> .
	___ The agency uses the resource methodologies of the SSI Program.
	___ The agency uses methodologies for treatment of resources that are more restrictive than the SSI program. These more restrictive methodologies are described in <u>Supplement 5 to ATTACHMENT 2.6-A</u> .

TN No: 08-017

Approval Date: 03/16/09

Effective Date 11/01/2008

Supersedes

TN No: NEW

CMS ID:

State/Territory: North Carolina

Citation	Condition or Requirement
----------	--------------------------

1902(a)(10)(A)  
(ii)(XVI) and 1905(v)(2)  
of the Act.

Definition of Employed – Employed Medically  
Improved Individuals – TWWIIA

     The agency uses the statutory definition of “employed”, i.e., earning at least the minimum wage, and working at least 40 hours per month.

  X   The agency uses an alternative definition of “employed” that provides for substantial and reasonable threshold criteria for hours of work, wages, or other measures. The agency’s threshold criteria is described below:

Gross earnings at least equivalent to those of an individual who is working 40 hours per month at minimum wage.

State/Territory: North Carolina

---

Citation	Condition or Requirement
----------	--------------------------

---

1902(a)(10)(A)(ii)(XIII)  
(XV), (XVI), and 1916(g)  
of the Act

Payment of Premiums or Other Cost Sharing Charges

For individuals eligible under the BBA eligibility group  
described in No. 23 on page 23d of ATTACHMENT 2.2-A:

- \_\_\_\_\_ The agency requires payment of premiums or other cost-sharing charges on a sliding scale based on income. The premiums or other cost-sharing charges, and how they are applied are described below:

Revision:

ATTACHMENT 2.6-A  
Page 12n  
OMB No.:

State/Territory: North Carolina

---

Citation	Condition or Requirement
----------	--------------------------

---

1902(a)(10)(A)(ii)  
(XIII), (XV), (XVI), and 1916(g)  
of the Act (cont.)

For individuals eligible under the Basic Coverage  
Group described in No. 24 on page 23f of  
ATTACHMENT 2.2-A, and the Medical Improvement Group  
described in No. 25 on page 23f of ATTACHMENT 2.2-A:

NOTE: Regardless of the option selected below, the agency  
MUST require that individuals whose annual adjusted gross  
income, as defined under IRS statute, exceeds \$75,000 pay 100  
percent of premiums.

X The agency requires individuals to pay premiums or  
other cost sharing charges on a sliding scale based on  
income. For individuals with net annual income below  
450 percent of the Federal poverty level for a family of  
the size involved, the amount of premiums cannot  
exceed 7.5 percent of the individual's income.

The premiums or other cost-sharing charges, and how  
they are applied are described on page 12o.

---

TN No. 13-045  
Supersedes  
TN No. 13-041

Approval Date 08-08-14

Effective Date: 10/1/2013

CMS ID:

State/Territory: North Carolina

Citation	Condition or Requirement
----------	--------------------------

Sections 1902(a)(10)(A)  
(ii)(XV), (XVI), and 1916(g)  
of the Act (cont.)

Premiums and Other Cost-Sharing Charges

For the Basic Coverage Group and the Medical Improvement Group, the agency's premium and other cost-sharing charges, and how they are applied, are described below.

<u>Federal Poverty Level</u>	<u>Yearly Enrollment fee</u>	<u>Monthly Premium</u>	<u>Yearly Premium</u>	<u>Total Yearly Cost Sharing</u>
<u>101-150%</u>	<u>0</u>	<u>0</u>	<u>0</u>	<u>0</u>
<u>151-200%</u>	<u>\$50</u>	<u>0</u>	<u>0</u>	<u>\$ 50</u>
<u>201-250%</u>	<u>\$50</u>	<u>\$139</u>	<u>\$1,668</u>	<u>\$1,718</u>
<u>251-300%</u>	<u>\$50</u>	<u>\$175</u>	<u>\$2,100</u>	<u>\$2,150</u>
<u>301-350%</u>	<u>\$50</u>	<u>\$211</u>	<u>\$2,532</u>	<u>\$2,582</u>
<u>351-400%</u>	<u>\$50</u>	<u>\$247</u>	<u>\$2,964</u>	<u>\$3,014</u>
<u>401-450%</u>	<u>\$50</u>	<u>\$283</u>	<u>\$3,396</u>	<u>\$3,446</u>
<u>451 and above</u>	<u>\$50</u>	<u>100%</u>		<u>100% + \$50</u>

M  
ethodology

DMA bases its 100% premium on the overall costs of Medicaid, excluding nonstandard populations that are ineligible or unlikely to participate in the HCWD program. Claims costs for all non-excluded individuals are aggregated by the month in which they were incurred and are converted to a PM/PM basis.

TN No. 13-045  
Supersedes  
TN No. 08-017-

Approval Date: 08-08-14

Effective Date: 10/01/2013

CMS ID:



State: North Carolina

---

Citation	Condition or Requirement
1902(k) of the Act	<p>2. Medicaid Qualifying Trusts</p> <p>In the case of a Medicaid qualifying trust described in section 1902(k)(2) of the Act, the amount from the trust that is deemed available to the individual who established the trust (or whose spouse established the trust) is the maximum amount that the trustee(s) is permitted under the trust to distribute to the individual. This amount is deemed available to the individual, whether or not the distribution is actually made. This provision does not apply to any trust or initial trust decree established before April 7, 1986, solely for the benefit of a mentally retarded individual who resides in an intermediate care facility for the mentally retarded.</p> <p>— The agency does not count the funds in a trust as described above in any instance where the State determines that it would work an undue hardship.</p>
1902(a)(10) of the Act	<p>3. Medically needy income levels (MNILs) are based on family size.</p> <p><u>Supplement 1 to ATTACHMENT 2.6-A</u> specifies the MNILs for all covered medically needy groups. If the agency chooses more restrictive levels under section 1902(f) of the Act, <u>Supplement 1</u> so indicates.</p>

State: North Carolina

Citation	Condition or Requirement
42 CFR 435.732, 435.831	<p>4. Handling of Excess Income - Spend-down for the Medically Needy in All States and the Categorically Needy in 1902(f) States Only</p> <p>a. <u>Medically Needy</u></p> <p>(1) Income in excess of the MNIL is considered as available for payment of medical care and services. The Medicaid agency measures available income for periods of either <u>6</u> or <u>*</u> month(s) (not to exceed 6 months) to determine the amount of excess countable income applicable to the cost of medical care and services.</p> <p>* For the 3 month period prior to the month of application, available income is measured for the 1, 2 or 3 consecutive month(s) period for which assistance is requested to determine the amount of excess countable income applicable to the cost of medical care and services.</p> <p>(2) If countable income exceeds the MNIL standard, the agency deducts the following incurred expenses in the following order:</p> <p>(a) Health insurance premiums, deductibles coinsurance charges.</p> <p>(b) Expenses for necessary medical and remedial care not included in the plan.</p> <p>(c) Expenses for necessary medical and remedial care included in the plan.</p> <p>Reasonable limits on amounts of expenses deducted from income under a.(2)(a) and (b) above are listed below.</p> <p>Incurred expenses that are subject to payment by a third party are not deducted unless the expenses are subject to payment by a third party that is a publicly funded program (other than Medicaid) of a State or local government.</p>

1902(a)(17)  
of the Act

Revision: HCFA-PM-91-8 (MB)  
October 1991

ATTACHMENT 2.6-A  
Page 14a  
OMB No.

State/Territory: North Carolina

---

Citation	Condition or Requirement
1903(f)(2) of the Act	a. <u>Medically Needy (Continued)</u>  ____ (3) If countable income exceeds the MNIL standard, the agency deducts spend down payments <u>made</u> to <u>the State</u> by the individual.

---

TN No. 92-27 Approval Date 1-31-94 Effective Date 7/1/92  
Supersedes  
TN No. NEW HCFA ID: 7985E/

State: North Carolina

---

Citation	Condition or Requirement
42 CFR 435.732	<p data-bbox="760 422 1568 485">b. <u>Categorically Needy - Section 1902 (f) States</u></p> <p data-bbox="857 516 1568 667">The agency applies the following policy under the provisions of section 1902(f) of the Act. The following amounts are deducted from income to determine the individual's countable income:</p> <ol data-bbox="857 699 1568 1409" style="list-style-type: none"><li data-bbox="857 699 1568 730">(1) Any SSI benefit received.</li><li data-bbox="857 762 1568 947">(2) Any State supplement received that is within the scope of an agreement described in section 1616 or 1634 of the Act, or a State supplement within the scope of section 1902(a)(10)(A) (ii)(XI) of the Act.</li><li data-bbox="857 978 1568 1163">(3) Increases in OASDI that are deducted under §§435.134 and 435.135 for individuals specified in that section, in the manner elected by the State under that section.</li><li data-bbox="857 1194 1568 1289">(4) Other deductions from income described in this plan at <u>Attachment 2.6-A, Supplement 4.</u></li><li data-bbox="857 1320 1568 1409">(5) Incurred expenses for necessary medical and remedial services recognized under State law.</li></ol>
1902(a)(17) of the Act, P.L. 100-203	Incurred expenses that are subject to payment by a third party are not deducted unless the expenses are subject to payment by a third party that is a publicly funded program (other than Medicaid) of a State or local government.

---

TN No. 92-01  
Supersedes  
TN No. 87-18

Approval Date 10-21-92

Effective Date 1/1/92

HCFA ID: 7985E

Revision: HCFA-PM-91-8 (MB)  
October 1991

ATTACHMENT 2.6-A  
Page 15a  
OMB No.:

State/Territory: North Carolina

---

Citation	Condition	or Requirement
1903(f)(2) of the Act	4. b. <u>Categorically Needy - Section 1902(f) States Continued</u>	(6) Spenddown payments made to the State by the individual.

NOTE: FFP will be reduced to the extent a  
State is paid a spenddown payment by the  
individual.

---

TN No. 92-27 Approval Date 1-31-94 Effective Date 7/1/92  
Supersedes  
TN No. NEW HCFA ID: 7985E/

State: North Carolina

---

Citation	Condition or Requirement
----------	--------------------------

---

5. Methods for Determining Resources

a. AFDC-related individuals (except for poverty level related pregnant women, infants, and children).

(1) In determining countable resources for AFDC-related individuals, the following method are used:

(a) The methods under the State's approved AFDC plan; and

X (b) The methods under the State's approved AFDC plan and/or any more liberal methods described in Supplement 8b to ATTACHMENT 2.6-A.

(2) In determining relative financial responsibility, the agency considers only the resources of spouses living in the same household as available to spouses and the resources of parents as available to children living with parents until the children become 21.

State North Carolina

---

Citation	Condition or Requirement
----------	--------------------------

---

5. Methods for Determining Resources

1902(a)(10)(A),  
1902(a)(10)(C),  
1902(m)(1)(B)  
and (C), and  
1902(r) of the Act

b. Aged individuals. For including individuals covered under section 1902(a)(10)(A)(ii)(X) of the Act, the agency used the following methods for treatment of resources:

\_\_\_ The methods of the SSI program.

X SSI methods and/or any more liberal methods described in Supplement 8b to ATTACHMENT 2.6-A.

\_\_\_ Methods that are more restrictive (except for individuals described in section 1902(m)(1) of the Act) and/or more liberal than those of the SSI program. Supplement 5 to ATTACHMENT 2.6-A describes the more restrictive methods and Supplement 8b to ATTACHMENT 2.6-A specifies the more liberal methods.

State: North Carolina

Citation	Condition or Requirement
1902(a)(10)(A), 1902(a)(10)(C), 1902(m)(1)(B), and 1902(r) of the Act	<p>In determining relative financial responsibility, the agency considers only the resources of spouse living in the same household as available to spouses.</p>
	c. <u>Blind individuals.</u> For blind individuals the agency uses the following methods for treatment of resources:
	___ The methods of the SSI program.
	<u>X</u> SSI methods and/or any more liberal methods described in <u>Supplement 8b to ATTACHMENT 2.6-A.</u>
	___ Methods that are more restrictive and/or more liberal than those of the SSI program. <u>Supplement 5 to ATTACHMENT 2.6-A</u> describe the more restrictive method and <u>Supplement 8b to ATTACHMENT 2.6-A</u> specify the more liberal methods.
	<p>In determining relative financial responsibility, the agency considers only the resources of spouses living in the same household as available to spouses and resources of parents as available to children living with parents until the children become 21.</p>



State North Carolina

Citation	Condition or Requirement
1902(a)(10)(A), 1902(a)(10)(C), 1902(m)(1)(B) and 1902(r)(2) of the Act	<p>d. <u>Disabled individuals, including individuals covered under section 1902(a)(10)(A)(ii)(X) of the Act.</u> The agency uses the following methods for the treatment of resources,:</p> <p>_____ The methods of the SSI program.</p> <p><u>X</u> SSI methods and/or any more liberal methods described in <u>Supplement 8a to ATTACHMENT 2.6-A.</u></p> <p>_____ Methods that are more restrictive (except for individuals described in section 1902(m)(1) of the Act) and/or more liberal than those under the SSI program. More restrictive methods are described in <u>Supplement 5 to ATTACHMENT 2.6-A</u> and more liberal methods, are specified in <u>Supplement 8b to ATTACHMENT 2.6-A.</u></p> <p>In determining relative financial responsibility, the agency considers only the resources of spouses living in the same household as available to spouses and the resources of parents as available to children living with parents until the children become 21.</p>
1902(1)(3) and 1902(r)(2) the Act	<p>e. <u>Poverty level pregnant women covered under sections 1902(a)(10)(A)(i)(IV) of and 1902(a)(10)(A)(ii)(IX)(A) of the Act.</u></p> <p>The agency uses the following methods in the treatment of resources.</p> <p>_____ The methods of the SSI program only.</p> <p>_____ The methods of the SSI program and/or any more liberal methods described in Supplement 5a or <u>Supplement 8b to ATTACHMENT 2.6-A.</u></p>

State: North Carolina

Citation	Condition or Requirement
	<p>Methods that are more liberal than those of SSI. The more liberal methods are specified in <u>Supplement 5a or Supplement 8b to ATTACHMENT 2.6-A.</u></p>
	<p><u>X</u> Not applicable. The agency does not consider resources in determining eligibility.</p>
	<p>In determining relative financial responsibility, the agency considers only the resources of spouses living in the same household as available to spouses and the resources of parents as available to children living with parents until the children become 21.</p>
1902(1)(3) and 1902(r)(2) of the Act	<p>f. <u>Poverty level infants covered under section 1902(a)(10)(A)(i)(IV) of the of Act.</u></p> <p>The agency uses the following methods for the treatment of resources:</p> <p>— The methods of the State's approved AFDC plan.</p> <p>— Methods more liberal than those in the State's approved AFDC plan (but not more restrictive), in accordance with section 1902(1)(3)(C) of the Act, as specified in <u>Supplement 5a of ATTACHMENT 2.6-A.</u></p>
1902(1)(3)(C) of the Act	<p>— Methods more liberal than those in the States approved AFDC plan (but not more restrictive), as described in <u>Supplement 5a of Supplement 8b to ATTACHMENT 2.6-A.</u></p>
1902(r)(2) of the Act	<p><u>X</u> Not applicable. The agency does not consider resources In determining eligibility.</p>

TN No. 92-01  
Supersedes  
TN No. 90-06

Approval Date 10-21-92

Effective Date 1/1/92

HCFA ID: 7985E

STATE PLAN UNDER TITLE XIX OF THE SOCIAL SECURITY ACT

State: North Carolina

ELIGIBILITY CONDITIONS AND REQUIREMENTS

Citation(s)

Condition or Requirement

1902(l)(3) and  
1902(r)(2)  
of the Act

g. 1. Poverty level children covered under section 1902(a)(10)(A)(i)(VI) of the Act.

The agency uses the following methods for the treatment of resources:

     The methods of the State's approved AFDC plan

1902(l)(3)(C)  
of the Act

     Methods more liberal than those in the State's approved AFDC plan (but not more restrictive), in accordance with section 1902(l)(3)(C) of the Act, as specified in Supplement 5a of ATTACHMENT 2.6-A.

1902 (r) (2)  
of the Act

     Methods more liberal than those in the State's approved AFDC plan (but not more restrictive), as described in Supplement 8b to ATTACHMENT 2.6A.

  X Not applicable. The agency does not consider resources in determining eligibility.

In determining relative financial responsibility, the agency considers only the resources of spouses living in the same household as available to spouses and the resources of parents as available to children living with parents until the children become 21.

TN No. 92-01  
Supersedes  
TN No. NEW

Approval Date 10-21-92

Effective Date 1-1-92

STATE PLAN UNDER TITLE XIX OF THE SOCIAL SECURITY ACT

State: North Carolina

ELIGIBILITY CONDITIONS AND REQUIREMENTS

Citation(s)	Condition or Requirement
1902(1)(3) and 1902(r)(2) of the Act	g. 2. <u>Poverty level children under section 1902(a)(10)(A)(i)(VII)</u>  The agency uses the following methods for the treatment of resources:  <u>    </u> The methods of the State's approved AFDC plan.
1902(1)(3)(C) the Act	<u>    </u> Methods more liberal than those in the State's approved AFDC plan (but not more restrictive) as specified in <u>Supplement 5a of ATTACHMENT 2.6-A.</u>
1902 (r) (2) of the Act	<u>    </u> Methods more liberal than those in the State's approved AFDC plan (but not more restrictive), as described in <u>Supplement 8a to ATTACHMENT 2.6-A.</u>  <u>  X</u> Not applicable. The agency does not consider resources in determining eligibility.

In determining relative responsibility, the agency considers only the resources of spouses living in the same household as available to spouses and the resources of parents as available to children living with parents until the children become 21.

TN No. 92-01  
Supersedes  
TN No. NEW

Approval Date 10-21-92

Effective Date 1-1-92

State/Territory: North Carolina

Citation	Condition or Requirement
1905(p)(1) (C) and (D) and 1902(r)(2) Act:	5. h. <u>For Qualified Medicare beneficiaries covered under section 1902(a)(10)(E)(i) of the Act the agency uses the following of the methods for treatment of resources:</u>  ___ The methods of the SSI program only.  <u>XX</u> The methods of the SSI program and/or more liberal methods as described in <u>Supplement 8b to ATTACHMENT 2.6-A.</u>
1905(s) of the Act	i. For qualified disabled and working individuals covered under section 1902 (a)(10)(E)(ii) of the Act, the agency uses SSI program methods for the treatment of resources.
1902(u) of the Act	j. For COBRA continuation beneficiaries, the agency uses the following methods for treatment of resources:  ___ The methods of the SSI program only.  ___ More restrictive methods applied under section 1902 (f) of the Act as described in Supplement 5 to Attachment 2.6-A.

TN No. 92-27  
Supersedes  
TN No. 92-01

Approval Date 1-31-94

Effective Date 7/1/92

HCFA ID: 7985E

State/Territory: North Carolina

Citation	Condition or Requirement
6.	<p data-bbox="761 407 1446 434">Resource Standard - Categorically Needy</p> <p data-bbox="761 470 1555 558">a. 1902(f) States (except as specified under items 6.c. and d. below) for aged, blind and disabled individuals:</p> <p data-bbox="857 594 1495 621">___ Same as SSI resource standards.</p> <p data-bbox="857 657 1247 684">___ More restrictive.</p> <p data-bbox="857 720 1555 808">The resource standards for other individuals are the same as those in the related cash assistance program</p> <p data-bbox="761 844 1555 898">b. Non-1902(f) States (except as specified under items 6.c. and d. below)</p> <p data-bbox="857 934 1523 1024">The resource standards are the same as those in the related cash assistance program.</p>

STATE PLAN UNDER TITLE XIX OF THE SOCIAL SECURITY ACT

State: North Carolina

ELIGIBILITY CONDITIONS AND REQUIREMENTS

---

Citation(s)	Condition or Requirement
1902(1)(3)(A), (B) and (C) of the Act	<p>c. For pregnant women and infants covered under the provisions of section 1902(a)(10)(A)(1)(IV) and 1902(a)(10)(A)(ii)(IX) of the Act, the agency applies a resource standard.</p> <p>— Yes. <u>Supplement 2 to ATTACHMENT 2.6-A</u> specifies the standard which, for pregnant women, is no more restrictive than the standard under the SSI program; and for infants is no more restrictive than the standard applied in the State's approved AFDC plan.</p> <p><u>X</u> No. The agency does not apply a resource standard to these individuals.</p>
1902(1)(3)(A) and (C) of the Act	<p>d. For children covered under the provisions of section 1902(a)(10)(A)(1)(VI) of the Act, the agency applies a resource standard.</p> <p>— Yes. <u>Supplement 2 to ATTACHMENT 2.6-A</u> specifies the standard which is no more restrictive than the standard applied in the State's approved AFDC plan.</p> <p><u>X</u> No. The agency does not apply a resource standard to these individuals.</p>

---

TN No. 92-01  
Supersedes  
TN No. 91-42

Approval Date 10-21-92

Effective Date 1-1-92

State: North Carolina

---

Citation	Condition or Requirement
1902(m)(1)(C) and (m)(2)(B) of the Act	e. For aged and disabled individuals described in section 1902(m)(1) of the Act who are covered under section 1902(a)(10)(A)(ii)(X) of the Act, the resource standard is:  ___ Same as SSI resource standards.  ___ Same as the medically needy resource standards, which are higher than the SSI resource standards (if the State covers the medically needy).  <u>Supplement 2 to ATTACHMENT 2.6-A</u> specifies the resource levels for these individuals.



State: North Carolina

---

Citation	Condition or Requirement
1902(a)(10)(C)(i) of the Act	7. Resource Standard - Medically Needy  a. Resource standards are based on family size.  b. A single standard is employed in determining resource eligibility for all groups.  c. In 1902(f) States, the resource standards is more restrictive than in 7.b. above for--  — Aged — Blind — Disabled
1905(p)(1)(C) of the Act	8. Resource Standard For qualified Medicare beneficiaries covered under section 1902(a)(10)(E)(i) of the Act, specified low-income Medicare beneficiaries, covered under section 1902 (a)(10)(E)(iii) of the Act, and qualifying individuals covered under section 1902(a)(10) (E)(iv) of the Act the resource standard is the amount described in section 1905(p)(1)(C) of the Act.
1905(s) of the Act	9. For qualified disabled and working individuals covered under section 1902 (a)(10)(E)(ii) of the Act, the resource standard for an individual or a couple (in the case of an individual with a spouse) is twice the SSI resource standard.

Revision: HCFA-PM-91-8 (MB)  
October 1991

ATTACHMENT 2.6-A  
Page 22a  
OMB No.: 0938-

State/Territory: North Carolina

---

Citation	Condition or Requirement
1902(u) of the Act	9.1 For COBRA continuation beneficiaries, the resource standard is:  — Twice the SSI resource standard for an individual.  — More restrictive standard as applied under section 1902(f) of the Act as described in Supplement 8 to Attachment 2.6-A.

---

TN No. 92-27  
Supersedes  
TN No. NEW

Approval Date 1-31-94

Effective Date 7/1/92

HCFA ID: 7985E

State: North Carolina

---

Citation	Condition or Requirement
----------	--------------------------

---

10. Excess Resources

- a. Categorically Needy, Qualified Medicare Beneficiaries, and Qualified Disabled and Working Individuals  

Any excess resources make the individual ineligible.
- b. Categorically Needy Only  

X This State has a section 1634 agreement with SSI. Receipt of SSI is provided for individuals while disposing of excess resources.
- c. Medically Needy  

Any excess resources make individual ineligible. Individuals with excess resources at the first moment of the month may become eligible later in the month when resources are reduce to the resource level. See SUPPLEMENT 8b to ATTACHMENT 2.6-A.

---

TN No. 94-36  
Supersedes  
TN No. 93-17

Approval Date 5-18-95

Effective Date 1-1-95

HCFA ID: 7985E

STATE North Carolina

---

Citation	Condition or Requirement
----------	--------------------------

---

c. For Qualified Disabled Working Individuals (QDWI's) defined in Section i905 (s) of the Act, coverage is available beginning with the first month the individual is determined to be a Disabled Working Individual (DWI) by the Social Security Administration but no more than three months prior to filing a QDWI application with the Medicaid agency. The eligibility determination is valid for --

- 12 months
- 6 months
- \_\_\_\_\_ months (no less than 6 months and no more than 12 months)

Revision: HCFA-PM-91-4 (BPD)  
AUGUST 1991

ATTACHMENT 2.6-A  
Page 24  
OMB No.: 0938

State: North Carolina

Citation	Condition or Requirement
42 CFR 435.914	<p>11. Effective Date of Eligibility</p> <p>a. Groups Other Than Qualified Medicare Beneficiaries</p> <p>(1) For the prospective period.</p> <p>Coverage is available for the full month if the following individuals are eligible at any time during the month.</p> <p><input checked="" type="checkbox"/> Aged, blind, disabled. See page 24a.</p> <p><input checked="" type="checkbox"/> AFDC-related.</p> <p>Coverage is available only for the period during the month for which the following individuals meet the eligibility requirements.</p> <p><input type="checkbox"/> Aged, blind, disabled. <input type="checkbox"/> AFDC-related.</p> <p>(2) For the retroactive period.</p> <p>Coverage is available for three months before the date of application if the following individuals would have been eligible had they applied:</p> <p><input checked="" type="checkbox"/> Aged, blind, disabled. See page 24a.</p> <p><input checked="" type="checkbox"/> AFDC-related.</p> <p>Coverage is available beginning the first day of the third month before the date of application if the following individuals would have been eligible at any time during that month, had they applied.</p> <p><input type="checkbox"/> Aged, blind, disabled. <input type="checkbox"/> AFDC related.</p>

TN NO. 92-01  
Supersedes  
TN No. 87-5

Approval Date 10-21-92

Effective Date 1/1/92  
HCFA ID: 7985E

STATE North Carolina

Applies to individuals who have no excess income or resources.

Medically Needy Aged, Blind and Disabled and Medically Needy AFDC-related individuals with excess income become eligible on the day that excess income is spent down.

AFDC related individuals and Medically Needy aged, blind and disabled individuals with excess resources become eligible on the day that resources are reduced to the resource limit.

---

TN No. 94-36  
Supersedes  
TN No. 92-01

Approval Date 5-18-95

Effective Date 1-1-95

STATE PLAN UNDER TITLE XIX OF THE SOCIAL SECURITY ACT

State: North Carolina

ELIGIBILITY CONDITIONS AND REQUIREMENTS

Citation(s)	Condition or Requirement
1920(b)(1) of the Act	<input checked="" type="checkbox"/> (3) For a presumptive eligibility for pregnant women only.  Coverage is available for ambulatory prenatal care for the period that begins on the day a qualified provider determines that a woman meets any of the income eligibility levels specified in <u>ATTACHMENT 2.6-A</u> of this approved plan. If the woman files an application for Medicaid by the last day of the month following the month in which the qualified provider made the determination of presumptive eligibility, the period ends on the day that the State agency makes the determination of eligibility based on that application. If the woman does not file an application for Medicaid by the last day of the month following the month in which the qualified provider made the determination, the period ends on that last day.
1902(e)(8) and 1905(a) of the Act	<input checked="" type="checkbox"/> b. For qualified Medicare beneficiaries defined in section 1905(p)(1) of the Act coverage is available beginning with the first day of the month after the month in which the individual is first determined to be a qualified Medicare beneficiary under section 1905(p)(1). The eligibility determination is valid for--  <input checked="" type="checkbox"/> 12 months <input type="checkbox"/> 6 months <input type="checkbox"/> ___ months (no less than 6 months and no more than 12 months)

---

Citation	Condition or Requirement
1902(a)(18) and 1902(f) of the Act	<p>12. Pre-OBRA 93 Transfer of Resources-Categorically and Medically Needy, Qualified Medicare Beneficiaries, and Qualified Disabled and Working Individuals</p> <p>The agency complies with the provisions of section 1917 of the Act with respect to the transfer of resources.</p> <p>Disposal of resources at less than fair market value affects eligibility for certain services as detailed in <u>Supplement 9 to Attachment 2.6-A.</u></p>
1917(c)	<p>13. Transfer of Assets - All eligibility groups</p> <p>The agency complies with the provisions of section 1917(c) of the Act, as enacted by OBRA 93, with regard to the transfer of assets.</p> <p>Disposal of assets at less than fair market value affects eligibility for certain services as detailed in <u>Supplement 9(a) to ATTACHMENT 2.6-A</u>, except in instances where the agency determines that the transfer rules would work an undue hardship.</p>
1917(d)	<p>14. Treatment of Trusts - All eligibility groups</p> <p>The agency complies with the provisions of section 1917(d) of the Act, as amended by OBRA 93, with regard to trusts.</p> <p>— The agency uses more restrictive methodologies under section 1902(f) of the Act, and applies those methodologies in dealing with trusts;</p> <p>— The agency meets the requirements in section 1917(d)(f)(B) of the Act for use of <u>Miller</u> trusts.</p> <p>The agency does not count the funds in a trust in any instance where the agency determines that the transfer would work an undue hardship, as described in <u>Supplement 10 to ATTACHMENT 2.6-A.</u></p>



STATE PLAN UNDER TITLE XIX OF THE SOCIAL SECURITY ACT

State: North Carolina

INCOME ELIGIBILITY LEVELS

A. MANDATORY CATEGORICALLY NEEDY

1. AFDC-Related Groups Other Than Poverty Level Pregnant Women and Infants:

<u>Family Size</u>	<u>Need Standard*</u>	<u>Payment Standard</u>	<u>Maximum Payment* Amounts</u>
1	\$362	The State applies	\$181
2	\$472	ratable reduction	\$236
3	\$544		\$272
4	\$594		\$297
5	\$648		\$324

2. Pregnant Women and Infants under Section 1902(a)(10)(1)(IV) of the Act:

Effective April 1, 1990, based on the following percent of the official Federal income poverty level for the size family involved as revised annually in The Federal Register.

     133 percent        X    185  Percent (no more than 185 percent) specify)

<u>Family Size</u>	<u>Income Level</u>
<u>  1  </u>	\$ <u>                    </u>
<u>  2  </u>	\$ <u>                    </u>
<u>  3  </u>	\$ <u>                    </u>
<u>  4  </u>	\$ <u>                    </u>
<u>  5  </u>	\$ <u>                    </u>

\* per month

TN No. 92-01  
Supersedes  
TN No. 90-11

Approval Date 10-21-92

Effective Date 1/1/92

HCFA ID: 7985E

State: North Carolina

A.I. AFDC - Related Groups Other Than Poverty Level Pregnant  
Women and Infants: continued

<u>Family Size</u>	<u>Need Standard</u>	<u>Payment Standard</u>	<u>Maximum Payment Amounts</u>
6	\$ 698		\$349
7	\$ 746		\$373
8	\$ 772		\$386
9	\$ 812		\$406
10	\$ 860		\$430
11	\$ 896		\$448
12	\$ 946		\$473
13	\$ 992		\$496
14	\$1042		\$521
Each additional add \$ 50			\$ 25

---

TNT No 92-01  
Supersedes  
TN No. NEW

Approval Date 10-21-92 Effective Date 1/1/92

STATE PLAN UNDER TITLE XIX OF THE SOCIAL SECURITY ACT

State: North Carolina

INCOME ELIGIBILITY LEVELS

- A. MANDATORY CATEGORICALLY NEEDY (Continued)
3. For children under Section 1902(a)(10)(A)(i)(VI) of the Act (children who have attained age 1 but have not attained age 6), the income eligibility level is 133 percent of the Federal poverty level (as revised annually in the Federal Register) for the size family involved.
  4. For children under Section 1902(a)(10)(A)(i)(VII) of the Act (children who were born after September 30, 1983 and have attained age 6 but have not attained age 19), the income eligibility level is 100 percent of the Federal poverty level (as revised annually in the Federal Register) for the size family involved.

STATE PLAN UNDER TITLE XIX OF THE SOCIAL SECURITY ACT

STATE: North Carolina

INCOME ELIGIBILITY LEVELS (Continued)

B. OPTIONAL CATEGORICALLY NEEDED GROUPS WITH INCOMES RELATED TO FEDERAL POVERTY LEVEL

1. Pregnant Women and Infants

The levels for determining income eligibility for optional groups of pregnant women and infants under the provisions of section 1902(a)(10)(A)(ii)(IX) and 1902(1)(2) of the Act are as follows:

Based on 185 percent of the official Federal income poverty level\* (no less than 133 percent and no more than 185 percent) .

<u>Family Size</u>	<u>Income Level</u>
<u>1</u>	\$ _____
<u>2</u>	\$ _____
<u>3</u>	\$ _____
<u>4</u>	\$ _____
<u>5</u>	\$ _____

\* for the size family involved as revised annually in the Federal Register.

STATE PLAN UNDER TITLE XIX OF THE SOCIAL SECURITY ACT

State: North Carolina

INCOME ELIGIBILITY LEVELS (Continued)

B. OPTIONAL CATEGORICALLY NEEDY GROUPS WITH INCOMES RELATED TO FEDERAL POVERTY LEVEL

2. Children Between Ages 6 and 8

The levels for determining income eligibility for groups of children who are born after September 30, 1983 and who have attained 6 years of age but are under 8 years of age under the provisions of section 1902(1)(2) of the Act are as follows:

Based on \_\_\_\_\_ percent (no more than 100 percent) of the official Federal income poverty line.

<u>Family Size</u>	<u>Income Level</u>
<u>1</u>	\$ _____
<u>2</u>	\$ _____
<u>3</u>	\$ _____
<u>4</u>	\$ _____
<u>5</u>	\$ _____
<u>6</u>	\$ _____
<u>7</u>	\$ _____
<u>8</u>	\$ _____
<u>9</u>	\$ _____
<u>10</u>	\$ _____

THIS PAGE NOT APPLICABLE AS THIS GROUP INCORPORATED INTO MANDATORY GROUPS.

TN No. 92-01  
Supersedes  
TN No. NEW

Approval Date 10-21-92

Effective Date 1/1/92

HCFA ID: 7985E

STATE PLAN UNDER TITLE XIX OF THE SOCIAL SECURITY ACT

STATE North Carolina

C. INCOME ELIGIBILITY LEVEL - MANDATORY GROUP OF QUALIFIED  
DISABLED WORKING INDIVIDUALS

The income of Qualified Disabled Working Individuals will  
not exceed 200 percent of the Federal Poverty Level.

The income eligibility level is 200 percent of the Federal  
Poverty Level.

---

TN No. 91-42

Supersedes

Approval Date 11-5-91

Effective Date 7/1/91

TN No. NEW

STATE PLAN UNDER TITLE XIX OF THE SOCIAL SECURITY ACT

State: North Carolina

INCOME ELIGIBILITY LEVELS (Continued)

3. Aged and Disabled Individuals

The levels for determining income eligibility for groups of aged and disabled individuals under the provisions of section 1902(m)(1) of the Act are as follows:

Based on 100% percent of the official Federal income poverty line for the size family involved as revised annually in the Federal Register.

<u>Family Size</u>	<u>Income Level</u>
<u>1</u>	\$ <u>                    </u>
<u>2</u>	\$ <u>                    </u>
<u>3</u>	\$ <u>                    </u>
<u>4</u>	\$ <u>                    </u>
<u>5</u>	\$ <u>                    </u>

If an individual receives a title II benefit, any amount attributable to the most recent increase in the monthly insurance benefit as a result of a title II COLA is not counted as income during a "transition period" beginning with January, when the title II benefit for December is received, and ending with the last day of the month following the month of publication of the revised annual Federal poverty level.

For individuals with title II income, the revised poverty levels are not effective until the first day of the month following the end of the transition period.

For individuals not receiving title II income, the revised poverty levels are effective no later than the beginning of the month following, the date of publication.

---

TN No. 99-02  
Supersedes  
TN No. 92-01

Approval Date 03/01/99

Effective Date 1/1/99

HCFA ID: 7985E

STATE PLAN UNDER TITLE XIX OF THE SOCIAL SECURITY ACT:

State North Carolina

D. INCOME LEVELS - MEDICALLY NEEDED (cont.)

Family Size	Net income level Protected for maintenance	Urban & Rural
11	\$600	
12	633	
13	667	
14	700	
For each additional person add:	\$ 33	

---

TN No. 90-11  
Supercedes  
TN No. 88-08

Approval Date 7-17-90  
Received: 6/28/90

Effective Date 4/1/90



STATE PLAN UNDER TITLE XIX OF THE SOCIAL SECURITY ACT

State: North Carolina

INCOME ELIGIBILITY LEVELS (Continued)

C. QUALIFIED MEDICARE BENEFICIARIES WITH INCOMES RELATED TO FEDERAL POVERTY LEVEL

The levels for determining income eligibility for groups of qualified Medicare beneficiaries under the provisions of section 1905(p)(2)(A) of the Act are as follows:

1. NON-SECTION 1902(f) STATES

a. Based on the following percent of the official Federal income poverty level:

Eff. Jan. 1, 1989: \_\_\_ 85 percent \_\_\_percent (no more than 100)  
Eff. Jan. 1, 1990: \_\_\_ 90 percent \_\_\_percent (no more than 100)  
Eff. Jan. 1, 1991: 100 percent  
Eff. Jan. 1, 1992. 100 percent

b. Levels:

Family Size

Income Levels

1  
2

\$ \_\_\_\_\_  
\$ \_\_\_\_\_

STATE PLAN UNDER TITLE XIX OF THE SOCIAL SECURITY ACT

State: North Carolina

INCOME ELIGIBILITY LEVELS (Continued)

D. QUALIFIED MEDICARE BENEFICIARIES WITH INCOMES RELATED TO FEDERAL POVERTY LEVEL

2. SECTION 1902(f) STATES WHICH AS OF JANUARY 1 1989 USED INCOME STANDARDS MORE RESTRICTIVE THAN SSI

a. Based on the following percent of the official Federal income poverty level:

Eff. Jan. 1, 1989: \_\_\_ 80 percent \_\_\_ percent (no more than 100)

Eff. Jan. 1, 1990: \_\_\_ 85 percent \_\_\_ percent (no more than 100)

Eff. Jan. 1, 1991: \_\_\_ 95 percent \_\_\_ percent (no more than 100)

Eff. Jan. 1, 1992: 100 percent

b. Levels:

Family Size

Income Levels

1  
2

\$ \_\_\_\_\_  
\$ \_\_\_\_\_

---

TN No. 94-36  
Supersedes  
TN No. 92-01

Approval Date 5-18-95

Effective Date 1-1-95

HCFA ID: 7985E

STATE PLAN UNDER TITLE XIX OF THE SOCIAL SECURITY ACT

State: North Carolina

INCOME LEVELS (Continued)

D. MEDICALLY NEEDY

Applicable to all groups.  Applicable to all groups except those specified below. Excepted group income levels are also listed on an attached page 3.

(1)	(2)	(3)	(4)	(5)
Family Size	Net income level protected for maintenance for <u>1</u> months	Amount by which Column (2) for exceeds limits specified in 42 CFR 435.1007	Net income level for persons living in rural areas for _____ months	Amount by which Column (4) exceeds limits specified in 42 CFR 435.1007

urban only

urban & rural

1	\$ 242	\$	\$	\$
2	\$ 317	\$	\$	\$
3	\$ 367	\$	\$	\$
4	\$ 400	\$	\$	\$

For each additional person, add: go to page 9

\$	\$	\$	\$
----	----	----	----

The agency has methods for excluding from its claim for FFP payments made on behalf of individuals whose income exceeds these limits.

TN No. .92-01

Supersedes

Approval Date 10-21-92

Effective Date 1/1/92

TN No. NEW

HCFA ID: 798SE

STATE PLAN UNDER TITLE XIX OF THE SOCIAL SECURITY ACT

State: North Carolina

INCOME LEVELS (Continued)

D. MEDICALLY NEEDY

(1)	(2)	(3)	(4)	(5)
Family Size	Net income level protected for maintenance for <u>1</u> months	Amount by which Column (2) for exceeds limits specified in 42 CFR 435.1007	Net income level for persons living in rural areas for _____ months	Amount by which Column (4) exceeds limits specified in 42 CFR 435.1007

X urban only

\_\_\_\_\_ urban & rural

5	\$ 433	\$	\$	\$
6	\$ 467	\$	\$	\$
7	\$ 500	\$	\$	\$
8	\$ 525	\$	\$	\$
9	\$ 542	\$	\$	\$
10	\$ 575	\$	\$	\$

For each additional person, add: see page 9a  
 \$ \$ \$ \$

The agency has methods for excluding from its claim for FFP payments made on behalf of individuals whose income exceeds these limits.

State North Carolina

D. MEDICALLY NEEDY - continued

Family Size	Net income level protected for maintenance for _____ month
11	\$600
12	\$633
13	\$667
14	\$700
each additional	\$ 33

---

TN No. 92-01  
Supersedes  
TN No. NEW

Approval Date 10-21-92

Eff. Date 1-1-92

Revision: HCFA-Region IV  
August 1991

SUPPLEMENT 1 TO ATTACHMENT 2.6-A  
Page 9a

STATE PLAN UNDER TITLE XIX OF THE SOCIAL SECURITY ACT

State: North Carolina

INCOME LEVELS (Continued)

- E. Optional Groups Other Than the Medically Needy
  - 1. Institutionalized Individuals Under Special Income Levels as follows:

---

TN No. 92-01  
Supersedes  
TN. No. NEW

Approval Date 10-21-92

Effective Date 1/1/92  
HCFA ID: 7985E

STATE PLAN UNDER TITLE XIX OF THE SOCIAL SECURITY ACT

State: North Carolina

RESOURCE LEVELS

A. CATEGORICALLY NEEDY GROUPS WITH INCOMES RELATED TO FEDERAL POVERTY LEVEL

1. Pregnant Women

a. Mandatory Groups

     Same as SSI resources levels.

  X   Less restrictive than SSI resource levels  
and is as follows:

<u>Family Size</u>	<u>Resource Level</u>	No resource test is applied
<u>  1  </u>	_____	
<u>  2  </u>	_____	

b. Optional Groups

     Same as SSI resources levels.

  X   Less restrictive than SSI resource levels and is  
as follows:

<u>Family Size</u>	<u>Resource Level</u>	No resource test is applied
<u>  1  </u>	_____	
<u>  2  </u>	_____	





STATE PLAN UNDER TITLE XIX OF THE SOCIAL SECURITY ACT

State: North Carolina

b. Optional Group of Infants

       Same as resource levels in the State's approved AFDC plan.

  X   Less restrictive than the AFDC levels and are as follows:

<u>Family Size</u>	<u>Resource Level</u>
<u>1</u>	<u>                                  </u>
<u>2</u>	<u>                                  </u>
<u>3</u>	<u>                                  </u>
<u>4</u>	<u>                                  </u>
<u>5</u>	<u>                                  </u>
<u>6</u>	<u>                                  </u>
<u>7</u>	<u>                                  </u>
<u>8</u>	<u>                                  </u>
<u>9</u>	<u>                                  </u>
<u>10</u>	<u>                                  </u>

No resource test is applied

STATE PLAN UNDER TITLE XIX OF THE SOCIAL SECURITY ACT

State: North Carolina

3. Children

a. Mandatory Group of Children under Section 1902(a)(10)(A)(i)(VI) of the Act. (Children who have attained age 1 but have not attained age 6.)

       Same as resource levels in the State's approved AFDC plan.

  X   Less restrictive than the AFDC levels and are as follows:

<u>Family Size</u>	<u>Resource Level</u>
<u>  1  </u>	_____
<u>  2  </u>	_____
<u>  3  </u>	_____
<u>  4  </u>	_____
<u>  5  </u>	_____
<u>  6  </u>	_____
<u>  7  </u>	_____
<u>  8  </u>	_____
<u>  9  </u>	_____
<u> 10  </u>	_____

No resource test is applied.



Revision: HCFA-PM-91-4 (BPD)  
AUGUST 1991

SUPPLEMENT 2 TO ATTACHMENT 2.6-A  
Page 6  
OMB No. 0938

STATE PLAN UNDER TITLE XIX OF THE SOCIAL SECURITY ACT

State: North Carolina

4. Aged and Disabled Individuals - Categorically Needy

Same as SSI resource levels.

More restrictive than SSI levels and are as follows:

<u>Family Size</u>	<u>Resource Level</u>
<u>1</u>	_____
<u>2</u>	_____
<u>3</u>	_____
<u>4</u>	_____
<u>5</u>	_____

Same as medically needy resource levels (applicable only if State has a medically needy program)

---

TN No. 94-36  
Supersedes  
TN No. 92-01

Approval Date 5-18-95

Effective Date 1-1-95

HCFA ID: 7985E

Revision: HCFA-PM-91-4 (BPD)  
AUGUST 1991

SUPPLEMENT 2 TO ATTACHMENT 2.6-A  
Page 7  
OMB No.: 0938-

STATE: PLAN UNDER TITLE XIX OF THE SOCIAL SECURITY ACT

State: North Carolina

RESOURCE LEVELS (Continued)

B. MEDICALLY NEEDED

Applicable to AFDC Related Groups

— Except those specified below under the provisions of section 1902(f) of the Act.

<u>Family Size</u>	<u>Resource Level</u>
<u>1</u>	<u>1500</u>
<u>2</u>	<u>2250</u>
<u>3</u>	<u>2350</u>
<u>4</u>	<u>2450</u>
<u>5</u>	<u>2550</u>
<u>6</u>	<u>2650</u>
<u>7</u>	<u>2750</u>
<u>8</u>	<u>2850</u>
<u>9</u>	<u>2950</u>
<u>10</u>	<u>3050</u>
For each additional person	<u>0</u>

---

TN No. 94-36  
Supersedes  
TN No. 92-01

Approval Date 5-18-95

Effective Date 1-1-95

HCFA ID: 7985E

STATE PLAN UNDER TITLE XIX OF THE SOCIAL SECURITY ACT

State: North Carolina

REASONABLE LIMITS ON AMOUNTS FOR NECESSARY MEDICAL OR  
REMEDIAL CARE NOT COVERED UNDER MEDICAID

The State projects non-covered medical expenses for six months.

---

TN.No. 91-08  
Supersedes  
TN No. 88-14

Approval Date 11/15/93

Effective Date 3/1/91

Revision: HCFP91-4 (BPD)  
AUGUST 1991

SUPPLEMENT 4 TO ATTACHMENT 2.6-A  
Page 1  
OMB No.: 0938-

STATE PLAN UNDER TITLE XIX OF THE SOCIAL SECURITY ACT

State: North Carolina

METHODS FOR TREATMENT OF INCOME THAT DIFFER FROM THOSE  
OF THE SSI PROGRAM

(Section 1902(f) more restrictive methods and criteria and State supplement criteria in SSI criteria State without section 1634 agreements and in section 1902 (f) States. Use to reflect more liberal methods only if you limit to State supplement recipients. DO NOT USE this supplement to reflect more liberal policies that you elect under the authority of section 1902 (r) (2) of the Act. Use Supplement 8a for section 1902 (r)(2) methods.)

---

TN No. 94-36  
Supersedes  
TN No. 93-16

Approval Date 5-18-95

Effective Date 1-1-95  
HCFA ID: 7985E

Revision: HCFA-PM-91-4 (BPD)  
AUGUST 1991

SUPPLEMENT 5 TO ATTACHMENT 2.6-A  
Page 1  
OMB No. 0938-

STATE PLAN UNDER TITLE XIX OF THE SOCIAL SECURITY ACT

State: North Carolina

MORE RESTRICTIVE METHODS OF TREATING RESOURCES THAN THOSE OF THE SSI  
PROGRAM - Section 1902 (f) States only

---

TN No. 94-36  
Supersedes  
TN No. 93-16

Approval Date 5-18-95

Effective Date 1-1-95  
HCFA ID: 7985E



Revision: HCFA-PM-91-4 (BPD)  
AUGUST 1991

SUPPLEMENT 5A TO ATTACHMENT 2.6-A  
Page 1  
OMB No.: 0938-

STATE PLAN UNDER TITLE XIX OF THE SOCIAL SECURITY ACT

State: North Carolina

METHODS FOR TREATMENT OF RESOURCES FOR INDIVIDUALS  
WITH INCOMES RELATED TO FEDERAL POVERTY LEVELS

(Do not complete if you are electing more liberal methods under the authority of section 1902 (r)(2) of the Act instead of the authority specific to Federal poverty levels. Use Supplement 8b for section 1902(r)(2) methods.)

---

TN No. 92-01  
Supersedes  
TN No. 87-5

Approval Date 10-21-92

Effective Date 1/1/92

HCFA ID: 7985E

Revision: HCFA-PM-91-4 (BPD)  
AUGUST 1991

SUPPLEMENT 7 TO ATTACHMENT 2.6-A  
Page 1  
OMB No.: 0938-

STATE PLAN UNDER TITLE XIX OF THE SOCIAL SECURITY ACT

State: North Carolina

INCOME LEVELS FOR 1902(f) STATES - CATEGORICALLY NEEDY  
WHO ARE COVERED UNDER REQUIREMENTS MORE RESTRICTIVE THAN SSI

---

TN No. 94-36  
Supersedes  
TN No. 92-01

Approval Date 5-18-95

Effective Date 1-1-95  
HCFA ID: 7985E

Revision: HCFA-PM-91-4 (BPD)  
AUGUST 1991

SUPPLEMENT 8 TO ATTACHMENT 2.6-A  
Page 1  
OMB No.: 0938-

STATE PLAN UNDER TITLE XIX OF THE SOCIAL SECURITY ACT

State: North Carolina

RESOURCE STANDARDS FOR 1902(f) STATES - CATEGORICALLY NEEDY

---

TN No. 94-36  
Supersedes  
TN No. 92-01

Approval Date 5-18-95

Effective Date 1-1-95  
HCFA ID: 7985E

STATE PLAN UNDER TITLE XIX OF THE SOCIAL SECURITY ACT

State: North Carolina

MORE LIBERAL METHODS OF TREATING INCOME UNDER  
SECTION 1902(r)(2) OF THE ACT\*

Section 1902(f) State  Non-Section 1902 (f) State

1. PREGNANT WOMEN UNDER SECTION 1902 (1) OF THE ACT--  
Methodologies less restrictive than AFDC.

In determining countable income, there is no deeming of parents income to the pregnant woman.

2. QUALIFIED CHILDREN UNDER AGE 19--  
Methodologies less restrictive than AFDC.

In determining countable income, disregard the income difference by family size in the amount of the AFDC payment standard and 100% of the Federal Poverty Level (as revised annually in the Federal Register) plus \$1.

3. INFANTS UNDER ONE YEAR OF AGE DESCRIBED IN SECTION 1902(1)(1)(B) OF THE ACT  
Methodologies less restrictive than AFDC.

In determining countable income, disregard the income difference by family size between 185% of the federal poverty level and 200% of the federal poverty level.

4. CHILDREN WHO HAVE ATTAINED ONE YEAR OF AGE BUT HAVE NOT ATTAINED 6 YEARS OF AGE DESCRIBED IN SECTION 1902(1)(1)(C) OF THE ACT  
Methodologies less restrictive than AFDC.

In determining countable income, disregard the income difference by family size between 133% of the federal poverty level and 200% of the federal poverty level.

\*More liberal methods may not result in exceeding gross income limitations under section 1903(f).

State Plan Under Title XIX of the Social Security Act

State: North Carolina

LESS RESTRICTIVE METHODS OF TREATING INCOME  
UNDER SECTION 1902(r)(2) OF THE ACT

X For 1902(r)(2) mandatory eligibility groups 1902 (a)(10)(A)(i)(III), 1902 (a)(10)(A)(i)(IV), 1902 (a)(10)(A)(i)(VI), 1902 (a)(10)(A)(i)(VII) and;  
For optional groups 1902 (a)(10)(C)(i)(III), 1902 (a)(10)(A)(ii)(I), 1902 (a)(10)(A)(ii)(IX), 1902 (a)(10)(A)(ii)(X), 1902 (a)(10)(A)(ii)(XV), 1902 (a)(10)(A)(ii)(XVI), and;

For 1905(p) groups 1902(a)(10)(E)(i), 1902(a)(10)(E)(ii), 1902(a)(10)(E)(iii), 1902(a)(10)(E)(iv):

All wages paid by the Census Bureau for temporary employment related to Census activities are excluded.

X The following income policy applies to the following groups of Medicaid eligibles:

- Qualified Medicare Beneficiaries, 1902(a)(10)(E)(i) and 1905(p)(1) of the Act
- Qualified Disabled and Working Individuals, 1902(a)(10)(E)(ii) and 1905(s) of the Act
- Specified Low-Income Medicare Beneficiaries, 1902(a)(10)(E)(iii) of the Act
- Qualifying Individuals, 1902(a)(10)(E)(iv)

Instead of the SSI methodology of determining income eligibility of an individual through deeming of income from ineligible individuals to eligible individuals, the State shall employ an income limit which is the appropriate percentage of poverty, for each of the groups listed above, for the number in the family.

The family shall consist of:

- The individual applying for assistance under one of the groups listed above and,
- If residing in the home with the individual, the following individuals:
  - The individual's spouse,
  - The individual's children and step-children under age 18, and
  - If the individual is under age 18, his parents and their ineligible children;Except for those individuals receiving public income maintenance payments.

Because all family members to whom income would be allocated are counted in determining the income limit, no income will be allocated to family members in the home. Only the income of those who are financially responsible for the individual under 1902(a)(17) of the Act shall be counted.

Should applying this policy cause an individual to be ineligible in one of the eligibility groups listed above, the State shall determine his eligibility for the group using the SSI income deeming methodology.

State Plan Under Title XIX of the Social Security Act

State: North Carolina

LESS RESTRICTIVE METHODS OF TREATING INCOME  
UNDER SECTION 1902(r)(2) OF THE ACT

1. For 1902(a)(10)(A)(ii)(X), 1902(a)(10)(E)(i), 1902(a)(10)(E)(iii), and 1902(a)(10)(E)(iv):

When the annual Social Security COLA and Federal Poverty Level adjustment cause ineligibility for Medicaid; disregard the most recent Social Security COLA increase.

This disregard continues until the individual loses Medicaid coverage or becomes eligible without this disregard.

2. For individuals eligible under § 1902(a)(10)(A)(ii)(XV) or § 1902(a)(10)(A)(ii)(XVI):

Disregard unearned income above the SSI federal benefit rate up to 150% of the federal poverty level.

3. When determining eligibility for medically needy individuals described at 42 CFR 435.301 (b)(1)(i), (iv) 42 CFR 435.301 (b)(1)(ii), 435.308 and 42 CFR 435.310, payments made under the authority of N.C. G.S. Section 6.18.(a) Article 9 of Chapter 143B, Part 30 Eugenics Asexualization and Sterilization Compensation Program are disregarded as income.

Revision:

SUPPLEMENT 8B TO ATTACHMENT 2.6-A  
Page 1

OMB No.: 0938-

STATE PLAN UNDER TITLE XIX OF THE SOCIAL SECURITY ACT

State: North Carolina

MORE LIBERAL METHODS OF TREATING RESOURCES

UNDER SECTION 1902(r)(2) OF THE ACT

\_\_\_\_\_ Section 1902(f) State

Non-Section 1902(f) State

1. AGED, BLIND AND DISABLED INDIVIDUALS, QUALIFIED MEDICARE BENEFICIARIES, SPECIFIED LOW-INCOME MEDICARE BENEFICIARIES, QUALIFYING INDIVIDUALS, AND ALL NON-MAGI RELATED GROUPS

Methodologies less restrictive than SSI.

- a. The value of personal effects and household goods are not counted.
- b. The current market value for real property is the tax assessed value. The tax assessed value may be reduced if evidence is provided proving that the current market value is less than the tax assessed value.
- c. For individuals not receiving optional State Supplements, the value of life estate interest in real property is not counted.
- d. For individuals not receiving optional State Supplements, the value of tenancy in common interest in real property is not counted.
- e. Value of burial plots are not counted.
- f. The cash value of life insurance when the total face value of all cash value bearing life insurance policies does not exceed ten thousand dollars is not counted.
- g. Up to \$12,000 of real property contiguous to the individual's principal place of residence when the individual has no ownership interest in his principal place of residence.
- h. Payments made under the authority of N.C.G.S. Section 6.18(a) Article 9 of Chapter 143B, Part 30 Eugenics Asexualization and Sterilization Compensation Program are not counted.

2. MEDICALLY NEEDY AGED, BLIND AND DISABLED INDIVIDUALS--  
Methodologies less restrictive than SSI

Individuals with resources in excess of the resource limit at the first moment of the month may become eligible at the point that resources are reduced to the allowable limit.

3. MEDICALLY NEEDY AFDC RELATED INDIVIDUALS  
Methodologies less restrictive than AFDC

- a. The value of real property is not counted.
- b. The value of one vehicle per adult is not counted.
- c. The value of trusts funds, burial contracts and retirement accounts is not counted.

---

TN No. 13-011

Supersedes

TN No. 03-01

Approval Date 11-26-14

Effective Date 10/01/2014

HCFA ID: 7985E

STATE PLAN UNDER TITLE XIX OF THE SOCIAL SECURITY ACT

State/Territory: North Carolina

MORE LIBERAL METHODS OF TREATING RESOURCES

UNDER SECTION 1902(r)(2) OF THE ACT

\_\_\_\_\_ Section 1902(f) State

Non-Section 1902(f) State

2. MEDICALLY NEEDY AGED (42 CFR 435.320), BLIND (42 CFR 435.322), AND DISABLED (42 CFR 435.224) INDIVIDUALS—

Methodologies less restrictive than SSI

Individuals with resources in excess of the resource limit at the first moment of the month may become eligible at the point that resources are reduced to the allowable limit.

3. AFDC RELATED INDIVIDUALS

- 1902(a)(10)(A)(i)(III) mandatory qualified pregnant women and children
- 1902(a)(10)(A)(ii)(I) optional AFDC eligible children – 1905(a)(i), parents and other caretaker relatives – 1905(a)(ii), and pregnant women – 1905(a)(viii)
- 1902(a)(10)(A)(ii)(III) optional parents and other caretaker relatives – 1905(a)(ii)
- 1902(a)(10)(C) optional medically needy children – 1905(a)(i), parents and other caretaker relatives – 1905(a)(ii), and pregnant women – 1905(a)(viii)

Methodologies less restrictive than AFDC

- a. The value of real property is not counted.
- b. The value of one vehicle per adult is not counted.
- c. The value of trusts funds, burial contracts and retirement accounts is not counted.



STATE PLAN UNDER TITLE XIX OF THE SOCIAL SECURITY ACT

STATE: North Carolina

MORE LIBERAL METHODS OF TREATING RESOURCES  
UNDER SECTION 1902(R)(2) OF THE ACT

   SECTION 1902(f) State        X   Non-Section 1902(f) State

4. QUALIFIED CHILDREN UNDER AGE 19

All resources are excluded

5. MEDICALLY NEEDY AFDC RELATED INDIVIDUALS

Methodologies less restrictive than AFDC

Disregards otherwise countable assets in the following amounts:

Family Size	Amount
1	1500
2	750
3	650
4	550
5	450
6	350
7	250
8	150
9	50
10	0

6. When determining eligibility for medically needy individuals described at 42 CFR 435.301 (b)(1)(i), (iv) 42 CFR 435.301 (b)(1)(ii), 435.308 and 42 CFR 435.310, payments made under the authority of N.C. G.S. Section 6.18.(a) Article 9 of Chapter 143B, Part 30 Eugenics Asexualization and Sterilization Compensation Program are disregarded as income.

STATE PLAN UNDER TITLE XIX OF THE SOCIAL SECURITY ACT

State: North Carolina

=====

STATE LONG-TERM CARE INSURANCE PARTNERSHIP

1902(r)(2) The following more liberal methodology applies to individuals who are  
1917(b)(1)(C) eligible for medical assistance under one of the following eligibility  
groups:

- Optional categorically needy individuals described in 1902(a)(10)(A)(ii)(I) and 1902(a)(10)(A)(ii)(X)
- Medically needy Aged (42 CFR 435.320), Blind (42 CFR 435.322), and Disabled (42 CFR 435.224) individuals
- Individuals described in 1902(a)(10)(A)(i)(II)
- Individuals described under 42 CFR 435.230

An individual, who is a beneficiary under a long-term care insurance policy that meets the requirements of a "qualified State long-term care insurance partnership" policy ("partnership policy") as set forth below, is given a resource disregard as described in this amendment. The amount of the disregard is equal to the amount of the insurance benefit payments made to or on behalf of the individual. The term "long-term care insurance policy" includes a certificate issued under a group insurance contract.

X The State Medicaid Agency (Agency) stipulates that the following requirements will be satisfied in order for a long-term care policy to qualify for a disregard. Where appropriate, the Agency relies on attestations by the State Insurance Commissioner (Commissioner) or other State official charged with regulation and oversight of insurance policies sold in the state, regarding information within the expertise of the State's Insurance Department.

- The policy is a qualified long-term care insurance policy as defined in section 7702B(b) of the Internal Revenue Code of 1986.
- The policy meets the requirements of the long-term care insurance model regulation and long-term care insurance model Act promulgated by the National Association of Insurance Commissioners (as adopted as of October 2000) as those requirements are set forth in section 1917(b)(5)(A) of the Social Security Act.
- The policy was issued no earlier than the effective date of this State plan amendment.
- The insured individual was a resident of a Partnership State when coverage first became effective under the policy. If the policy is later exchanged for a different long-term care policy, the individual was a resident of a Partnership State when coverage under the earliest policy became effective.

TN No. 10-027  
Supersedes  
TN No. NEW

Approval Date 01-06-11

Effective Date: 01/01/2011

STATE PLAN UNDER TITLE XIX OF THE SOCIAL SECURITY ACT

State: North Carolina

=====

STATE LONG-TERM CARE INSURANCE PARTNERSHIP

- The policy meets the inflation protection requirements set forth in section 1917(b)(1)(C)(iii)(IV) of the Social Security Act.
- The Commissioner requires the issuer of the policy to make regular reports to the Secretary that include notification regarding when benefits provided under the policy have been paid and the amount of such benefits paid, notification regarding when the policy otherwise terminates, and such other information as the Secretary determines may be appropriate to the administration of such partnerships.
- The State does not impose any requirement affecting the terms or benefits of a partnership policy that the state does not also impose on non-partnership policies.
- The State Insurance Department assures that any individual who sells a partnership policy receives training, and demonstrates evidence of an understanding of such policies and how they relate to other public and private coverage of long-term care.
- The Agency provides information and technical assistance to the Insurance Department regarding the training described above.

TN No. 10-027  
Supersedes  
TN No. NEW

Approval Date 01-06-11

Effective Date: 01/01/2011

Revision: HCFA-PM-85-3 (BERC)  
FEBRUARY 1985

SUPPLEMENT 9 TO ATTACHMENT 2.6-A  
Page 1

STATE PLAN UNDER TITLE XIX OF THE SOCIAL SECURITY ACT

State: North Carolina

TRANSFER OF RESOURCES

1902(f) and 1917  
of the Act

- A. The agency provides for nursing facility or equivalent services as specified in Section 1917 (c) of the Social Security Act.

---

TN No. 91-18  
Supersedes  
TN No. 86-19

Approval Date 7/24/91

Effective Date 4/1/91

STATE PLAN UNDER TITLE XIX OF THE SOCIAL SECURITY ACT

State: North Carolina

- B. An institutionalized individual who (or whose spouse) transfers resources for less than the fair market value shall not be found ineligible for nursing facility services, for a level of care in a medical institution equivalent to that of a nursing facility services, or for home and community-based services where the State determines that denial of eligibility would work undue hardship under the provision of Section 1917 (c) (2) (D) of the Social Security Act.
  
- C. A non-institutionalized individual who (or whose spouse) transfers resources for less than the fair market value shall not be found ineligible for in-home health services and supplies where the State determines that denial of eligibility would work undue hardship under the provision of Section 1917(c)(2)(D) of the Social Security Act.

---

TN No. 03-02  
Supersedes  
TN No. 91-18

Approval Date 05/22/03

Effective Date 2-1-03

STATE PLAN UNDER TITLE XIX OF THE SOCIAL SECURITY ACT

State: North Carolina

TRANSFER OF ASSETS

1917(c) The agency provides for the denial of certain Medicaid services by reason of disposal of assets for less than fair market value.

1. Institutionalized individuals may be denied certain Medicaid services upon disposing of assets for less than fair market value on or after the look-back date.

The agency withholds payment to institutionalized individuals for the following services:

Payments based on a level of care in a nursing facility;

Payments based on a nursing facility level of care in a medical institution;

Home and community-based services under a 1915 waiver.

2. Non-institutionalized individuals:

X The agency applies these provisions to the following non-institutionalized eligibility groups. These groups can be no more restrictive than those set forth in section 1905 (a) of the Social Security Act:

Mandatory and optional categorically needy and medically needy Aged, Blind, Disabled individuals covered in ATTACHMENT 2.2-A of this Plan and qualified Medicare Beneficiaries described in 1905(p)(1). However, it does not apply to State Supplements (42 CFR 435.130 & 435.230.)

The agency withholds payment to non-institutionalized individuals for the following services:

X Home health services (section 1905(a)(7));

Home and community care for functionally disabled and elderly adults (section 1905(a)(22));

X Personal care services furnished to individuals who are not inpatients in certain medical institutions, as recognized under agency law and specified in section 1905(a)(24).

The following other long-term care services for which medical assistance is otherwise under the agency plan:

State: North Carolina

TRANSFER OF ASSETS

1. Penalty Date—The beginning date of each penalty period imposed for an uncompensated transfer of assets is:

x the first day of the month in which the asset was transferred;  
     the first day of the month following the month of transfer.

2. Penalty Period - Institutionalized Individuals—  
In determining the penalty for an institutionalized individual, the agency uses:

x the average monthly cost to a private patient of nursing facility services in the agency;  
     the average monthly cost to a private patient of nursing facility services in the community in which the individual is institutionalized.

3. Penalty Period Non-institutionalized Individuals--  
The agency imposes a penalty period determined by using the same method as is used for an institutionalized individual, including the use of the average monthly cost of nursing facility services;

     imposes a shorter penalty than would be imposed for institutionalized individuals, as outlined below:

State: North Carolina

TRANSFER ASSETS

4. Penalty period for amounts of transfer less than cost of nursing facility care-

a. Where the amount of the transfer is less than the monthly cost of nursing facility care, the agency:

X does not impose a penalty;

\_\_\_\_\_ imposes a penalty for less than a full month, based on the proportion of the agency's private nursing facility rate that was transferred.

b. Where an individual makes a series of transfers, each less than the private nursing facility rate for a month, the agency:

X does not impose a penalty;

\_\_\_\_\_ Imposes a series of penalties, each for less than a full month.

5. Transfer made so that penalty periods would overlap-  
The agency:

X totals the value of all assets transferred to produce a single penalty period;

\_\_\_\_\_ calculates the individual penalty periods and impose them sequentially.

6. Transfers made so that penalty periods would not overlap-  
The agency:

X assigns each transfer its own penalty period;

\_\_\_\_\_ uses the method outlined below:



State: North Carolina

TRANSFER ASSETS

9. Penalty periods - transfer by a spouse that results in a penalty period for the individual-

- (a) The agency apportions any existing penalty period between the spouses using the method outlined below, provided the spouse is eligible for Medicaid. A penalty can be assessed against the spouse, and some portion of the penalty against the individual remains.

When both spouses are institutionalized the penalty period is divided equally between the spouses.

When both spouses are non-institutionalized the penalty period is divided equally between the spouses.

- (b) If one spouse is no longer subject to a penalty, the remaining penalty period must be served by the remaining spouse.

10. Treatment of income as an asset--When income has been transferred as a lump sum, the agency will calculate the penalty period on the lump sum value.

     The agency will impose partial month penalty periods.

When a stream of income or the right to a stream of income has been transferred, the agency will impose a penalty period for each income payment.

     For transfers of individual income payments, the agency will impose partial month penalty periods.

     For transfers of the right to an income stream, the agency will use the actuarial value of all payments transferred.

  X   The agency uses an alternate method to calculate penalty periods, as described below:

The agency adds each income payment and imposes a full month penalty the first day of the month in which income transferred equals the average monthly cost of nursing facility services.

Revision: HCFA-PM-95-1 (MB)  
MARCH 1995

SUPPLEMENT 9(a) to ATTACHMENT 2.6-A  
Page 5

State: North Carolina

TRANSFER ASSETS

11. Imposition of penalty would work an undue hardship--  
The agency does not apply the transfer of assets provisions in any case in which the agency determines that such an application would work an undue hardship.

The following criteria will be used to determine whether the agency will not count assets transferred because the penalty would work an undue hardship:

When application of transfer of assets provisions would deprive an individual of medical care such that his health or life would be endangered or deprive individual of food, clothing, shelter, or other necessities of life.

---

TN No. 95-06  
Supersedes  
TN No. NEW

Approval Date 6-14-95

Effective Date 4-1-95

STATE PLAN UNDER TITLE XIX OF THE SOCIAL SECURITY ACT

State: North Carolina

TRANSFER OF ASSETS

1917(c) For Transfers Of Assets for less than fair market value made on or after February 8, 2006, the agency provides for the denial of certain Medicaid services according to section 1917(c) of the Social Security Act, as amended by the Deficit Reduction Act of 2005 (P.L. 109-71).

1. Institutionalized individuals are denied coverage of certain Medicaid services upon disposing of assets for less than fair market value on or after the look-back date.

The agency does not provide medical assistance coverage for institutionalized individuals for the following services:

Nursing facility services;

Nursing facility level of care provided in a medical institution;

Home and community-based services under a 1915(c) or (d) waiver.

2. Non-institutionalized individuals:

X The agency applies these provisions to the following non-institutionalized eligibility groups. These groups can be no more restrictive than those set forth in section 1905(a) of the Social Security Act:

Mandatory and optional categorically needy and medically needy Aged, Blind, Disabled individuals covered in ATTACHMENT 2.2-A of this Plan and qualified Medicare Beneficiaries described in 1905(p)(1). However, it does not apply to State Supplements (42 CFR 435.130 & 435.230).

The agency withholds payment to non-institutionalized individuals for the following services:

X Home health services (section 1905(a)(7));

Home and community care for functionally disabled elderly adults (section 1905(a)(22));

STATE PLAN UNDER TITLE XIX OF THE SOCIAL SECURITY ACT

State: North Carolina

TRANSFER OF ASSETS

- Personal care services furnished to individuals who are not inpatients in certain medical institutions, as recognized under agency law and specified in section 1905(a)(24).
- The following other long-term care services for which payment for medical assistance is otherwise made under the agency plan:

3. Penalty period start date – The penalty period begins:
- For uncompensated transfers by or on behalf of individuals receiving Medicaid payment for long-term care services, on the first day of the month following advance notice of the penalty period, but no later than the first day of the month that follows three full calendar months from the date of the report or discovery of the transfer; or
  - For uncompensated transfers by individuals requesting Medicaid payment of long-term care services, on the date on which the person is eligible for medical assistance under the state plan and would receive institutional level long-term care services but for the imposition of the penalty period.

The penalty period cannot begin until any existing penalty period for uncompensated transfers has expired.

4. Penalty Period - Institutionalized Individuals--  
In determining the penalty for an institutionalized individual, the agency uses:
- the average monthly cost to a private patient of nursing facility services in the State at the time of application;
- the average monthly cost to a private patient of nursing facility services in the community in which the individual is institutionalized at the time of application.

STATE PLAN UNDER TITLE XIX OF THE SOCIAL SECURITY ACT

State: North Carolina

TRANSFER OF ASSETS

5. Penalty Period - Non-institutionalized Individuals--  
The agency imposes a penalty period determined by using the same method as is used for an institutionalized individual, including the use of the average monthly cost of nursing facility services;
- \_\_\_ imposes a shorter penalty period than would be imposed for institutionalized individuals, as outlined below:
6. Penalty period for amounts of transfer less than cost of nursing facility care--
- X Where the amount of the transfer is less than the monthly cost of nursing facility care, the agency imposes a penalty for less than a full month, based on the option selected in item 4.
- X The state adds together all transfers for less than fair market value made during the look-back period in more than one month and calculates a single period of ineligibility, that begins on the earliest date that would otherwise apply if the transfer had been made in a single lump sum.
7. Penalty periods - transfer by a spouse that results in a penalty period for the individual--
- (a) The agency apportions any existing penalty period between the spouses using the method outlined below, provided the spouse is eligible for Medicaid. A penalty can be assessed against the spouse, and some portion of the penalty against the individual remains.
- (b) If both spouses are eligible for Medicaid and receiving institutional services or non-institutional services described in item 2., above, the penalty period is divided equally between the spouses.
- (c) If one spouse is in a penalty period when the other spouse becomes eligible for Medicaid and begins to receive institutional services or non-institutional services described in item 2, above, the remaining penalty period is divided between the two spouses.

STATE PLAN UNDER TITLE XIX OF THE SOCIAL SECURITY ACT

State: North Carolina

TRANSFER OF ASSETS

- (d) If one spouse is no longer subject to a penalty, the remaining penalty period must be served by the remaining spouse.

8. Treatment of a transfer of income—

When income has been transferred as a lump sum, the agency will calculate the penalty period on the lump sum value.

When a stream of income or the right to a stream of income has been transferred, the agency will impose a penalty period for each income payment.

X For transfers of individual income payments, the agency will impose partial month penalty periods using the methodology selected in 6. above.

\_\_\_ For transfers of the right to an income stream, the agency will base the penalty period on the combined actuarial value of all payments transferred.

9. Imposition of a penalty would work an undue hardship--

The agency does not impose a penalty for transferring assets for less than fair market value in any case in which the agency determines that such imposition would work an undue hardship. The agency will use the following criteria in making undue hardship determinations:

Application of a transfer of assets penalty would deprive the individual:

- (a) Of medical care such that the individual's health or life would be endangered; or  
(b) Of food, clothing, shelter, or other necessities of life.

STATE PLAN UNDER TITLE XIX OF THE SOCIAL SECURITY ACT

State: North Carolina

TRANSFER OF ASSETS

10. Procedures for Undue Hardship Waivers

The agency has established a process under which hardship waivers may be requested that provides for:

- (a) Notice to a recipient subject to a penalty that an undue hardship exception exists;
- (b) A timely process for determining whether an undue hardship waiver will be granted; and
- (c) A process, which is described in the notice, under which an adverse determination can be appealed.

These procedures shall permit the facility in which the institutionalized individual is residing to file an undue hardship waiver application on behalf of the individual with the consent of the individual or the individual's personal representative.

11. Bed Hold Waivers For Hardship Applicants

The agency provides that while an application for an undue hardship waiver is pending in the case of an individual who is a resident of a nursing facility:

\_\_\_\_\_ Payments to the nursing facility to hold the bed for the individual will be made for a period not to exceed \_\_\_\_\_ days (may not be greater than 30).

DEC 17 1986

DEFINITION OF BLINDNESS

An individual shall be considered to be blind if he has central visual acuity of 20/200 or less in the better eye with the use of a correcting lens. An eye which is accompanied by a limitation in the fields of vision such that the widest diameter of the visual field subtends an angle no greater than 20 degrees shall be considered as having a central visual acuity of 20/200 or less. An individual shall also be considered to be blind as defined under the State Plan approved under Title XVI as in effect for October 1972 and received aid under such plan (on the basis of blindness) for December 1973, so long as he is continuously blind as so defined.

DEFINITION OF DISABILITY

Disability is inability to engage in any substantial gainful activity due to a medically determinable physical or mental impairment that can be expected to result in death, or has lasted, or can be expected to last 12 months or longer. An individual shall also be considered to be disabled if he is permanently and totally disabled as defined under the State Plan approved under Title XVI as in effect for October 1972 and received aid under such plan (on the basis of blindness) for December 1973, so long as he is continuously blind as so defined.

Neither of the above definitions is more liberal than the SSI definitions for the condition.

---

TN. No. 86-19  
Supersedes  
TN. No. 85-03

Approval Date 7/7/87

Eff. Date 12/22/86



STATE PLAN UNDER TITLE XIX OF THE SOCIAL SECURITY ACT

State: North Carolina

The agency does not apply the trust provisions in any case in which the agency determines that such application would work an undue hardship.

The following criteria will be used to determine whether the agency will not count assets transferred because doing so would work an undue hardship:

When application of trust provisions would deprive an individual of medical care such that his health or life would be endangered or deprive the individual of food, clothing, shelter, or other necessities of life.

Under the agency's undue hardship provisions, the agency exempts the funds in an irrevocable burial trust.

The agency does not impose a limit as long as the burial contract itemizes each burial item and or service.

---

TN No. 95-06  
Supersedes  
TN No. 86-19

Approval Date 6-14-95

Effective Date 4-1-95

State/Territory: North Carolina

---

Citation	Condition or Requirement
----------	--------------------------

---

1902(u) of  
the Act

COST EFFECTIVENESS METHODOLOGY FOR  
COBRA CONTINUATION BENEFICIARIES

Premium payments are made by the agency only if such payments are likely to be cost effective. The agency specifies the guidelines used in determining cost effectiveness by selecting one of the following methods:

- The methodology as described in SMM section 3598.
- Another cost-effective methodology as described below.

---

TN No. 92-27  
Supersedes  
TN No. NEW

Approval Date 1-31-94

Effective Date 7/1/92

HCFA ID: 7985E

STATE PLAN UNDER TITLE XIX OF THE SOCIAL SECURITY ACT

State: North Carolina

ELIGIBILITY UNDER SECTION 1931 OF THE ACT

The State covers low-income families and children under section 1931 of the Act.

The following groups were included in the AFDC State plan effective July 16, 1996:

x Pregnant women with no other eligible children.

x AFDC children age 18 who are full-time students in a secondary school or in the equivalent level of vocational or technical training.

     In determining eligibility for Medicaid, the agency uses the AFDC standards and methodologies in effect as of July 16, 1996, without modification.

     In determining eligibility for Medicaid, the agency uses the AFDC standards and methodologies in effect as of July 16, 1996, with the following modifications:

         The agency applies lower income standards which are no lower than the AFDC standards in effect on May 1, 1988, as follows:

         The agency applies higher income standards than those in effect as of July 16, 1996, increased by no more than the percentage increases in the CPI-U since July 16, 1996, as follows:

         The agency applies higher resource standards than those in effect as of July 16, 1996, increased by no more than the percentage increases in the CPI-U since July 16, 1996, as follows:

x The agency uses less restrictive income and/or resource methodologies than those in effect as of July 16, 1996, as follows:

1. Disregards the first \$2,000.00 of otherwise countable resources for applicants and recipients.
2. Disregards the value of one motor vehicle per adult in addition to disregard of \$2,000.00 of otherwise countable resources.
3. Disregards the value of real property,
4. Disregards trust funds, burial contracts and retirement accounts.
5. For budgeting purposes, prorates contract income over the period of time the contract is intended to cover. In cases where this methodology gives a more restrictive outcome than the July 16, 1996 methodology, the July 16, 1996 methodology is used.
6. Exclude all cash assistance payments made under the State TANF plan.
7. Disregards 100% of earnings for 3 months, for applicants and recipients who begin a permanent job where they will work at least 20 hours per week.
8. Disregards 27.5% of the caretaker relative's earned income. If this disregard results in a more restrictive outcome than the July 1, 1996 methodology, the July 1996 methodology will be applied.
9. Disregards the value of food not eaten by a case member who is temporarily absent from the home.
10. Excludes all wages paid by the Census Bureau for temporary employment related to Census activities.

The income and/or resource methodologies that the less restrictive methodologies replace are as follows:

1. Resource limit of \$1000.00 regardless of family size. No otherwise countable resources may be disregarded.
2. Disregards \$1,500.00 equity value of one vehicle.
3. Counts the value of real property.
4. Counts the value of trust funds, revocable burial contracts and retirement accounts if the retirement funds can be withdrawn in an lump sum.
5. Contract income budgeted using base period of one month.
6. Item 8, above, replaces a methodology that disregards \$90 from the earned income of any member of the case plus costs for child/incapacitated adult care up to \$200 for child under 2 and \$175 for each child age 2 an over and incapacitated adult.
7. Item 9, above, replaces a methodology that counts as income the value of food not eaten by a case member who is temporarily absent from the home.

---

TN No.: 07-007

Approval Date: 10/30/07

Effective Date: 07/01/07

Supersedes

TN No.: 03-008

The agency terminates medical assistance (except for certain pregnant women and children) for individuals who fail to meet TANF work requirements.

  x   The agency continues to apply the following waivers of provisions of Part A of Title IC in effect as of July 16, 1996, or submitted prior to August 22, 1996 and approval by the Secretary on or before July 1, 1997.

Waiver of sections 402(a)(41), 45 CFR 233.100 and 45 CFR 233.100(c) through which the State eliminated the 100 hour rule when determining the eligibility of two parent families. This allows the deprivation requirement to be met even if the principal earner is employed more than the 100 hours.

---

TN No. 99-28  
Supercedes  
TN No. new

Approval Date 1/28/00

Effective Date 11-01-99

State Plan Under Title XIX of the Social Security Act

State: North Carolina

ELIGIBILITY UNDER SECTION 1931 OF THE ACT

The State covers low-income families and children under Section 1931 of the Act.

X The agency used less restrictive income and/or resource methodologies than those in effect as of July 16, 1996, as follows:

All wages paid by the Census Bureau for temporary employment related to Census 2000 activities are excluded.

— The income and/or resource methodologies that the less restrictive methodologies replace are as follows:

TN No. 00-06  
Supersedes  
TN No. NEW

Approval Date Apr. 06, 2000

Eff. Date 1/01/00

STATE PLAN UNDER TITLE XIX OF THE SOCIAL SECURITY ACT

State: North Carolina

VARIATIONS FROM THE BASIC PERSONAL NEEDS ALLOWANCE

SPECIAL PERSONAL NEEDS ALLOWANCE FOR PERSONS WITH GREATER NEED:

In addition to the standard personal needs allowance, the sum of the following, not to exceed the income maintenance level provided by North Carolina statute for a single individual (or a couple, if in the same LTC room) in a private living arrangement.

1. Mandatory non-discretionary deductions from income.
2. An incentive allowance for individual who are regularly engaged in work activities as a part of a development plan and for whom retention of additional income contributes to their achievement of independence. The formula for the incentive is as follows:

<u>Monthly Net Wages</u>	<u>Monthly Incentive Allowance</u>
\$1 to \$100	All up to \$50
\$101 to \$200	\$80
\$201 to \$300	\$130
\$301 to greater	\$212

3. Individuals, for whom a guardian of the estate has been named by the court, shall be allowed, for payment of guardianship fees whichever of the following amounts is less:
  - a. 10% of total monthly income from all sources, both earned and unearned;
  - OR
  - b. \$25 per month

Revision: HCFA-PM-97-2  
December 1997

SUPPLEMENT 12A TO ATTACHMENT 2.6-A  
Page 2  
OMB No.: 0938-0673

STATE PLAN UNDER TITLE XIX OF THE SOCIAL SECURITY ACT

State: North Carolina

VARIATIONS FROM THE BASIC PERSONAL NEEDS ALLOWANCE- Continued

1924 of the SSA II  
CFR 435.725  
CFR 435.733  
CFR 435.832

4. In addition to the basic personal needs allowance, the personal needs allowance is increased by the amount of compensation paid to the individual from the Eugenics Asexualization and Sterilization Compensation Fund.



STATE PLAN UNDER TITLE XIX OF THE SOCIAL SECURITY ACT

State: North Carolina

ASSET VERIFICATION SYSTEM

- 1940(a) 1. of the Act
- The agency will provide for the verification of assets for purposes of determining or redetermining Medicaid eligibility for aged, blind and disabled Medicaid applicants and recipients using an Asset Verification System (AVS) that meets the following minimum requirements.
- A. The request and response system must be electronic:
    - (1) Verification inquiries must be sent electronically via the internet or similar means from the agency to the financial institution (FI).
    - (2) The system cannot be based on mailing paper-based requests.
    - (3) The system must have the capability to accept responses electronically.
  - B. The system must be secure, based on a recognized industry standard of security (e.g., as defined by the U.S. Commerce Department's National Institute of Standards and Technology, or NIST).
  - C. The system must establish and maintain a database of FIs that participate in the agency's AVS.
  - D. Verification requests also must be sent to FIs other than those identified by applicants and recipients, based on some logic such as geographic proximity to the applicant's home address, or other reasonable factors whenever the agency determines that such requests are needed to determine or redetermine the individual's eligibility.
  - E. The verification requests must include a request for information on both open and closed accounts, going back up to 5 years as determined by the State.

STATE PLAN UNDER TITLE XIX OF THE SOCIAL SECURITY ACT

State: North Carolina

ASSET VERIFICATION SYSTEM

2. System Development

A. The agency itself will develop an AVS.

In 3 below, provide any additional information the agency wants to include.

B. The agency will hire a contractor to develop an AVS.

In 3 below provide any additional information the agency wants to include.

C. The agency will be joining a consortium to develop an AVS.

In 3 below, identify the States participating in the consortium. Also, provide any other information the agency wants to include pertaining to how the consortium will implement the AVS requirements.

D. The agency already has a system in place that meets the requirements for an acceptable AVS.

In 3 below, describe how the existing system meets the requirements in Section 1.

E. Other alternative not included in A. – D. above.

In 3 below, describe this alternative approach and how it will meet the requirements in Section 1.

STATE PLAN UNDER TITLE XIX OF THE SOCIAL SECURITY ACT

State: North Carolina

ASSET VERIFICATION SYSTEM

3. Provide the AVS implementation information requested for the implementation approach checked in Section 2, and any other information the agency may want to include.

The contractor will have the capacity, requisite experience, and expertise to provide AVS services for NCDHHS, in accordance with the provisions and requirements set forth. The contractor will meet the asset verification system requirements set forth in Section 1040 of P.L. 110-252. The contractor will ensure the quality of services provided and immediately take necessary and corrective steps upon identification of inappropriate, undesirable, or otherwise poor service or upon notification by representatives of NCDHHS. The contractor will meet or exceed specific and measurable performance standards as outlined in the RFP. The contractor will have an independent auditor, approved by NCDHHS, perform a Level II SAS 70 audit biennially. The system will comply with the national standards prescribed by the Health Insurance Portability and Accountability Act of 1996 and the Balanced Budget Act of 1997, and will be kept in compliance with new and modified requirements.

STATE PLAN UNDER TITLE XIX OF THE SOCIAL SECURITY ACT

State: North Carolina

DISQUALIFICATION FOR LONG-TERM CARE ASSISTANCE FOR INDIVIDUALS WITH  
SUBSTANTIAL HOME EQUITY

1917(f) The State agency denies reimbursement for nursing facility services and other long-term care services covered under the State plan for an individual who does not have a spouse, child under 21 or adult disabled child residing in the individual's home, when the individual's equity interest in the home exceeds the following amount:

\$500,000 (increased by the annual percentage increase in the urban component of the consumer price index beginning with 2011, rounded to the nearest \$1,000).

An amount that exceeds \$500,000 but does not exceed \$750,000 (increased by the annual percentage increase in the urban component of the consumer price index beginning with 2011, rounded to the nearest \$1,000).

The amount chosen by the State is \_\_\_\_\_.

This higher standard applies statewide.

This higher standard does not apply statewide. It only applies in the following areas of the State:

This higher standard applies to all eligibility groups.

This higher standard only applies to the following eligibility groups:

The State has a process under which this limitation will be waived in cases of undue hardship.

STATE PLAN UNDER TITLE XIX OF THE SOCIAL SECURITY ACT

State North Carolina

ELIGIBILITY CONDITIONS AND REQUIREMENTS FOR THE MEDICALLY NEEDY

I. Non-financial eligibility

For families and children, and aged, blind, and disabled individuals, the non-financial eligibility conditions are the same as those applicable to the categorically needy as described in Section II of ATTACHMENT 2.6-A, except with respect to blind and disabled individuals as described in Section C of ATTACHMENT 2.2-A.

II Financial eligibility

A. Treatment of income

1. Income levels by family size

a. The minimum net income level for maintenance is as described below and as indicated in the table below:

X 1. The higher of the payment standards generally used as a measure of financial eligibility in the money payment programs, as specified in 45 CFR 248.3(c)(1)(ii).

X This level does not exceed 133 1/3 percent of the highest amount ordinarily paid to an AFDC family of comparable size, as specified in 45 CFR 248.4(b)(4).

\_\_\_\_\_ This level exceeds 133 1/3 percent of the highest amount ordinarily paid to an AFDC family of comparable size, as specified in 45 CFR 248.4(b)(4.). The State agency has methods for excluding from its claim for Federal financial participation payments of amounts equivalent to those in columns (3) and (5) in the table below.

Rec'd \_\_\_\_\_ OPC 11# 74-66 Dated \_\_\_\_\_

R.O. Action 3/12/75 EFF. Date 1/1/74

Obsoleted by \_\_\_\_\_ Dated \_\_\_\_\_

State North Carolina

     ii. A level higher than that specified in Item i above.

         This level does not exceed 133 1/3 Percent of the highest amount ordinarily paid to an AFDC family of comparable size, as specified in 45 CFR 248.4(b)(4).

         This level exceeds 133 1/3 percent of the highest amount ordinarily paid to an AFDC family of comparable size, as specified in 45 CFR 248.4(b)(4). The State agency has methods for excluding from its claim for Federal financial participation payments of amounts equivalent to those in columns (3) and (5) in the table below.

     iii. A level lower than that specified in Item I above, but no lower than 133 1/3 percent of the highest amount ordinarily paid to an AFDC family of comparable size, as specified in 45 CFR 248.4(b)(4).

a. The State agency uses urban and rural differentials in establishing the amounts of net income protected for maintenance.

     Yes. These amounts are indicated in columns (2) and (4) of the table below.

  x   No. The net income levels for all medically needy individuals are as stated in column 2 of the table below.

Rec'd          OPC-11 # 74-66 Dated         

R.O. Action 3/12/75 Eff. Date 1/1/74

Obseleted by          Dated

State North Carolina

The income levels for the medically needy are specified below:

Family Size	Semi-Annual Net income level protected for maintenance  <input type="checkbox"/> Urban only <input checked="" type="checkbox"/> urban only	Semi-Annual Amount by which Column (2) exceeds limits specified in 45 CFR 248.4	Net income level for person living in rural areas	Amount by which Column (4) exceeds limits specified in 45 CFR 248.4
(1)	(2)	(3)	(4)	(5)
1	\$ 1050	\$	\$	\$
2	\$ 1350	\$	\$	\$
3	\$ 1550	\$	\$	\$
4	\$ 1700	\$	\$	\$
5	\$ 1850	\$	\$	\$
6	\$ 2000	\$	\$	\$
7	\$ 2150	\$	\$	\$
8	\$ 2250	\$	\$	\$
9	\$ 2350	\$	\$	\$
10	\$ 2450	\$	\$	\$
For each additional Add:	\$ 100	\$	\$	\$

SENT BY OPC-11 # 79-18

DATED 8-7-79

R.O. ACTION DATE 10-15-79

EFF. DATE 7-1-79

OBSOLETE BY \_\_\_\_\_

DATED \_\_\_\_\_

State North Carolina

2. Income disregards

a. In determining net income for families and children, the disregards and set-asides and exemption of work-related expenses in the State's approved AFDC plan are applied.

b. In determining net income for aged individuals, the following disregards are applied

The disregards of the SSI program.

The disregards of the State supplementary payment program

The disregards of the SSI program, except for the restrictions specified in section II B-1 of ATTACHMENT 2.6-A

c. In determining net income for blind individuals, the following disregards are applied:.

The disregards of the SSI program.

The disregards of the State supplementary payment program.

The disregards of the SSI program, except for the restrictions specified in section II-B-2 of ATTACHMENT 2.6-A.

d. In determining net income for disabled individuals, the following disregards are applied:

The disregards of the SSI program.

The disregards of the State supplementary payment program

The disregards of the SSI program, except for the restrictions specified in section II-B-3 of ATTACHMENT 2.6-A.

Rec'd \_\_\_\_\_ OPC-11 # 74-66 Dated \_\_\_\_\_

R.O. Action 3/12/75 Eff. Date 1/1/74

Obsoleted by \_\_\_\_\_ Dated \_\_\_\_\_



State North Carolina

3. Handling of Excess Income

- a. Income in excess of the amount protected for maintenance, as specified in the table on page 3 of this ATTACHMENT is considered as available for payment of medical care and services. The State agency measures available income for the following period to determine the amount of excess income applicable to the cost of medical care and services:

6 months

- b. Excess income may be applied to medical and remedial care and services not encompassed in the plan:

X Without limitation or exceptions

\_\_\_ With the exception of the care and service specified below:

B. Treatment of resources

1. The resource levels:

\_\_\_ Are the same as the level specified in the State's approved AFDC plan or the SSI program whichever is higher for a family of a particular size.

\_\_\_ Exceed the level specified in the State's approved AFDC plan or the SSI program, whichever is higher for a family of a particular size.

X A supplement to this ATTACHMENT describes the limitations imposed on resources for the medically needy.

SENT BY OPC-11 # 79-18

DATED 8-7-79

R.O. ACTION DATE 10-15-79

EFF. DATE 7-1-79

OBSOLETE BY \_\_\_\_\_

DATED \_\_\_\_\_

State: North Carolina

2. The method(s) checked below is used in handling resources in excess of those specified above:

Excess non-income producing property (except the home) must be disposed of

Any excess resources render the individual ineligible

Other described as follows:

---

TN #01-30-11  
Supersedes  
TN. #74-66

dated 10/2/80

HHS Approval 10/10/80

Effective 9/1/80

Resource Levels

<u>Number of Persons</u>	<u>Resources Allowed Held in Reserve</u>
1	\$1,000
2	\$1,100
3	\$1,150
4	\$1,200
5	\$1,250
6	\$1,300
7	\$1,350
8	\$1,400

For each additional person add \$50 up to maximum of \$2,000.

Items Counted in Reserve

1. Cash
2. Liquid assets - savings, checking accounts, stocks and bonds, cash value of life insurance policies when total face value of policies in possession of the person exceeds \$1,500, and other investments.
3. Equity in real property not used as a home or not producing income.
4. Equity in the loan value of non-essential motor vehicles
5. Equity value of \$1,000 or less in essential motor vehicles.

Items Exempt from the Reserve

1. Real property used as a home- No maximum established.
2. Real property producing income.
3. Personal clothing and effects.
4. Essential household furnishings and appliances.
5. Equity value of \$1,000 or less in essential motor vehicles.
6. Cash value of life insurance policies when the total face value of all policies does not exceed \$1,500.

Approved Date 3/12/75  
55-74-66

Revision: MSA-PI-75-3  
August 20, 1974

Supplement to Attachment 2.6-C  
Page 5

State North Carolina

The resource limitations are the same for the medically needy as for the categorically needy except that burial plots are excluded as a resource for the medically needy and any property producing any income is excluded.

SENT BY OPC-11 # 7918

DATED 8-7-79

R.O. ACTION DATE 10-15-79

EFF. DATE 7-1-79

OBSOLETE BY \_\_\_\_\_

DATED \_\_\_\_\_

State/Territory: North Carolina

AMOUNT, DURATION, AND SCOPE OF MEDICAL AND  
REMEDIAL CARE AND SERVICES PROVIDED TO THE CATEGORICALLY NEEDY

---

Inpatient hospital services other than those provided in an institution for mental diseases.

Provided:  No Limitations  With Limitations

2.a. Outpatient hospital services.

Provided:  No Limitations  With Limitations

b. Rural health clinic services and other ambulatory services furnished by a rural health clinic (which are otherwise included in the State Plan).

Provided:  No Limitations  With Limitations

Not Provided.

c. Federally qualified health center (FQHC) services and other ambulatory services that are covered under the plan and furnished by an FQHC in accordance with section 4231 of the State Medicaid Manual (HCFA-Pub. 45-4).

Provided:  No Limitations  With Limitations

Not Provided.

3. Other laboratory and X-ray services.

Provided:  No Limitations  With Limitations

\*Description provided on attachment. 3.1-A.1

---

State/Territory: North Carolina

AMOUNT, DURATION, AND SCOPE OF MEDICAL AND  
REMEDIAL CARE AND SERVICES PROVIDED TO THE CATEGORICALLY NEEDY

4.a. Nursing facility services (other than services in an institution for mental diseases)  
for individuals 21 years of age or older.

Provided:  No limitations  With limitations\*

4.b. Early and periodic screening, diagnostic and treatment services for individuals under  
21 years of age, and treatment of conditions found.

4.c. Family planning services and supplies for individuals of child-bearing age.

Provided:  No limitations  With limitations\*

4.d 1) Face-to-Face Tobacco Cessation Counseling Services provided (by):

(i) By or under supervision of a physician;

(ii) By any other health care professional who is legally authorized to furnish such services  
under State law and who is authorized to provide Medicaid coverable services *other* than  
tobacco cessation services; or\*

(iii) Any other health care professional legally authorized to provide tobacco cessation  
services under State law *and* who is specifically *designated* by the Secretary in regulations.  
(None are designated at this time; this item is reserved for future use.)

\*describe if there are any limits on who can provide these counseling services

2) Face-to-Face Tobacco Cessation Counseling Services Benefit Package for Pregnant  
Women

Provided:  No limitations\*  With limitations\*\*

\*The State is providing at least four (4) counseling sessions per quit attempt.

\*\* Any benefit package that consists of *less* than four (4) counseling sessions per quit  
attempt should be explained below.

Please describe any limitations:

\* Description provided on attachment.

Revision: HCFA-PM-93-5 (MB)  
MAY 1993

ATTACHMENT 3.1-A  
Page 2a  
OMB NO:

State/Territory: North Carolina

AMOUNT, DURATION, AND SCOPE OF MEDICAL AND  
REMEDIAL CARE AND SERVICES PROVIDED TO THE CATEGORICALLY NEEDY

- 5.a. Physicians' services whether furnished in the office, the patient's home, a hospital, a nursing facility or elsewhere.
- Provided:  No Limitations  With limitations\*
- b. Medical and surgical services furnished by a dentist (in accordance with section 1905(a)(5)(B) of the Act).
- Provided:  No Limitations  With limitations\*
- 6.a. Medical care and any other type of remedial care recognized under State law, furnished by licensed practitioners within the scope of their practice as defined by State law.
- Podiatrists' services.
- Provided:  No limitations  With limitations\*

\* Description provided on attachment.

---

TN No. 13-005  
Supersedes  
TN No. NEW

Approval Date: 12-16-13

Effective Date 07/01/2013

AMOUNT, DURATION, AND SCOPE OF MEDICAL AND  
REMEDIAL CARE AND SERVICES PROVIDED TO THE CATEGORICALLY NEEDY

b. Optometrists services.

/X/ Provided: // No Limitations /X/ With Limitations\*

// Not provided.

c. Chiropractor's services.

/X/ Provided: // No Limitations /X/ With Limitations

d. Other practitioners' services.

/X/ Provided: Identified on attached sheet with description of limitations, if any.

Nurse Practitioner criteria described in Attachment 3.1-A.1, Page 12a.

// Not provided.

Certified Registered Nurse Anesthetists (CRNA) criteria described in Appendix 8 of Attachment 3.1-A.

// Not provided

Anesthesiologist Assistant criteria described in Appendix 8 of Attachment 3.1-A.

/X/ Provided

7. Home health services.

a. Intermittent or part-time nursing services provided by a home health agency or by a registered nurse when no home health agency exists in the area.

Provided: // No Limitations /X/ With Limitations\*

b. Home health aide services provided by a home health agency.

Provided: // No Limitations /X/ With Limitations\*

c. Medical supplies, equipment, and appliances suitable for use in the home.

Provided: // No Limitations /X/ With Limitations\*

\* Description provided on attachment: See 3.1-A.1



Revision: HCFA-PM-91-4 (BPD)  
AUGUST 1991

ATTACHMENT 3.1-A  
Page 3a  
OMB No.: 0938-

State/Territory: North Carolina

AMOUNT, DURATION, AND SCOPE OF MEDICAL AND  
REMEDIAL CARE AND SERVICES PROVIDED TO THE CATEGORICALLY NEEDY

- d. Physical therapy, occupational therapy, or speech pathology and audiology services provided by a home health agency or medical rehabilitation facility.

Provided:  No limitations  With limitations\*  
 Not provided.

8. Private duty nursing services.

Provided:  No limitations  With limitations\*  
 Not provided.

\* Description provided on attachment.

---

TN. No. 92-01  
Supersedes  
TN. No. NEW

Approval Date 10-21-92

Effective Date 1/1/92  
HCFA ID: 7986E

AMOUNT, DURATION AND SCOPE OF MEDICAL AND  
REMEDIAL CARE AND SERVICES PROVIDED TO THE CATEGORICALLY NEEDY

9. Clinic services.

Provided:     No limitations     With limitations\*

Not provided.

10. Dental services.

Provided:     No limitations     With limitations\*

Not provided.

11. Physical therapy and related services.

a. Physical therapy.

Provided:     No limitations     With limitations\*

Not provided.

b. Occupational therapy.

Provided:     No limitations     With limitations\*

Not provided.

c. Services for individuals with speech, hearing, and language disorders (provided by or under the supervision of a speech pathologist or audiologist).

Provided:     No limitations     With limitations\*

Not provided.

\* Description provided on attachment. See 3.1-A.1

---

SENT BY OPC-11 # 86-05

DATED 6-20-86

R.O. ACTION DATE 7-1-86

EFF. DATE 4-1-86

OBSOLETE BY \_\_\_\_\_

DATED \_\_\_\_\_

HCFA ID: 0069P/0002P

AMOUNT, DURATION AND SCOPE OF MEDICAL AND  
REMEDIAL CARE AND SERVICES PROVIDED TO THE CATEGORICALLY NEEDY

12. Prescribed drugs, dentures, and prosthetic devices and eyeglasses prescribed by a physician skilled in diseases of the eye or by an optometrist.

a. Prescribed drugs.

Provided:     No limitations             With limitations\*

Not provided.

b. Dentures.

Provided:     No limitations             With limitations\*

Not provided.

c. Orthotic and Prosthetic devices.

Provided:     No limitations             With limitations\*

Not provided.

d. Eyeglasses.

Provided:     No limitations             With limitations\*

Not provided.

13. Other diagnostic, screening, preventive, treatment, and rehabilitative services, i.e., other than those provided elsewhere in the plan.

a. Diagnostic services

Provided:     No limitations             With limitations\*

Not provided.

\*Description provided in Attachment 3.1-A.1.

AMOUNT, DURATION AND SCOPE OF MEDICAL AND  
REMEDIAL CARE AND SERVICES PROVIDED TO THE CATEGORICALLY NEEDY

b. Screening services.

Provided:     No limitations     With limitations\*

Not provided.

c. Preventive services.

Provided:     No limitations     With limitations\*

Not provided.

d. Rehabilitative services.

Provided:     No limitations     With limitations\*

Not provided.

14. Services for individuals age 65 or older in institutions for mental disease.

a. Inpatient hospital services.

Provided:     No limitations     With limitations\*

Not provided.

b. Skilled nursing facility services.

Provided:     No limitations     With limitations\*

Not provided.

c. Intermediate care facility services.

Provided:     No limitations     With limitations\*

Not provided.

\* Description provided on attachment. See 3.1-A.1

AMOUNT, DURATION AND SCOPE OF MEDICAL AND  
REMEDIAL CARE AND SERVICES PROVIDED TO THE CATEGORICALLY NEEDY

15.a. Intermediate care facility services (other than such services in an institution for mental diseases) for persons determined, in accordance with section 1902(a)(31)(A) of the Act, to be in need of such care.

Provided:  No limitations  With limitations\*

Not provided.

b. Including such services in a public institution (or distinct part thereof) for the mentally retarded or persons with related conditions.

Provided:  No limitations  With limitations\*

Not provided.

16. Inpatient psychiatric facility services for individuals under 21 years of age.

Provided:  No limitations  With limitations\*

Not provided.

Definition of services described in Appendix 2 to Attachment 3.1-A, page 1.

17. Nurse-midwife services.

Provided:  No limitations  With limitations\*

Not provided.

18. Hospice care (in accordance with section 1905(o) of the Act).

Provided:  No limitations  Provided in accordance with section 2302 of the Affordable Care Act

With limitations\*

\*Description provided on attachment.

STATE PLAN UNDER TITLE XIX OF THE SOCIAL SECURITY ACT

State/Territory: NORTH CAROLINA

AMOUNT, DURATION AND SCOPE OF MEDICAL AND  
REMEDIAL CARE AND SERVICES PROVIDED TO THE CATEGORICALLY NEEDY

---

19. Case management services and Tuberculosis related services

- a. Case management services as defined in, and to the group specified in, Supplement 1 to ATTACHMENT 3.1-A (in accordance with section 1905(a)(19) or section 1915(g) of the Act).

Provided:       With limitations\*

Not provided.

- b. Special tuberculosis (TB) related services under section 1902(z)(2)(F) of the Act.

Provided:       With limitations\*

Not provided.

20. Extended services for pregnant women

- a. Pregnancy-related and postpartum services for a 60-day period after the pregnancy ends and any remaining days in the month in which the 60th day falls.

Additional coverage ++

- b. Services for any other medical conditions that may complicate pregnancy.

Additional coverage ++

++ Attached is a description of increases in covered services beyond limitations for all groups described in this attachment and/or any additional services provided to pregnant women only.

\*Description provided on attachment.

State/Territory: North Carolina

AMOUNT, DURATION, AND SCOPE OF MEDICAL AND  
REMEDIAL CARE AND SERVICES PROVIDED TO THE CATEGORICALLY NEEDY

21. Ambulatory prenatal care for pregnant women furnished during a presumptive eligibility period by an eligible provider (in accordance with section 1920 of the Act).

Provided:  No limitations  With limitations\*

Not provided.

22. Respiratory care services (in accordance with section 1902(e)(9)(A) through (C) of the Act).

Provided:  No limitations  With limitations\*

Not provided.

23. Certified pediatric or family nurse practitioner's services.

Provided:  No limitations  With limitations\*

\*Description provided on attachment.

20. **DESCRIPTION OF EXTENDED SERVICES TO PREGNANT WOMEN**

Pregnancy related and postpartum services include:

Physician  
Clinic, including rural health and migrant health  
In-patient hospital  
Outpatient hospital  
Prescription drugs

The above services are provided to all Medicaid eligibles. The restrictions specified in ATTACHMENT 3.1-A.1 apply to all eligibles including pregnant women. Services available to pregnant women do not exceed the scope of services available to other eligible individuals or groups.

**Childbirth Education Classes**

Childbirth education classes include a series of classes designed to help prepare pregnant women and their support person for the labor and delivery experience. The-classes are based on a written curriculum that outlines the course objectives and specific content to be covered in each class as approved and published in Medicaid Clinical Coverage Policies at the NC Division of Medical Assistance website, [www.dhhs.state.nc.us/dma/mp/mpindex.htm](http://www.dhhs.state.nc.us/dma/mp/mpindex.htm).

Qualified providers must:

- be enrolled with the N.C. Medicaid Program; and
- be certified as a childbirth educator by a nationally recognized organization for childbirth education or meet State-approved childbirth education program requirements; and be a licensed practitioner operating within the scope of their practice as defined under State law or
- be under the personal supervision of an individual licensed under State law to practice medicine.



### Dietary Evaluation and Counseling

Dietary Evaluation and Counseling, when provided by a qualified nutritionist to Medicaid eligible pregnant and postpartum women identified as having high risk conditions by their prenatal care provider include but is not limited to:

- Nutrition Assessment
- Development of an individualized care plan
- Diet therapy
- Counseling, education about needed nutrition habits/skills and follow-up
- Communication with the WIC Program, Baby Love Program and prenatal care provider as appropriate.

The high risk indicators used to assess pregnant and postpartum women's medical need for the services are as follows:

1. Conditions that impact the length of gestation or the birth weight, where nutrition is an underlying cause, such as:
  - a. severe anemia (HGB<10M/DL or HCT<30)
  - b. pre-conceptionally underweight (<90% standard weight for height)
  - c. inadequate weight gain during pregnancy
  - d. intrauterine growth retardation
  - e. very young maternal age (under the age of 16)
  - f. multiple gestation
  - g. substance abuse
2. metabolic disorders such as diabetes, thyroid dysfunction, maternal PKU, or other inborn errors of metabolism
3. chronic medical conditions such as cancer, heart disease, hypertension, hyperlipidemia, inflammatory bowel disease, malabsorption syndromes, or renal disease
4. auto-immune diseases of nutritional significance such as systemic lupus erythematosus
5. eating disorders such as severe pica, anorexia nervosa, or bulimia nervosa
6. obesity when the following criteria are met:
  - BMI >30 in same woman pre-pregnancy and post partum
  - BMI >35 at 6 weeks of pregnancy
  - BMI >30 at 12 weeks of pregnancy
7. a documented history of a relative of the first degree with cardiovascular disease and/or possessing factors that significantly increase the risk of cardiovascular disease such as a sedentary lifestyle, elevated cholesterol, smoking, high blood pressure, greater than ideal body weight

Provider Qualifications

Medicaid enrolled providers who employ licensed dietitians/nutritionists or registered dietitians are eligible to provide dietary evaluation and counseling. It is the responsibility of the provider agency to verify in writing that staff meet the following qualifications:

1. A dietitian/nutritionist, currently licensed by the N.C. Board of Dietetics/Nutrition (provisional license is not acceptable)
2. A registered dietitian, currently registered with the Commission of Dietetic Registration (registration eligibility is not acceptable).

Coordination with WIC

This nutrition service is not intended to replace WIC nutrition education contacts. All individuals receiving this service must be referred to WIC to receive the two WIC nutrition education contacts.

Other Services

Other services described in this attachment and restrictions described in Attachment 3.1-A.1 apply to all pregnant women except those that are entitled as optionally categorically needy pregnant women. For this latter category of pregnant women only pregnancy-related services and family planning services are available.

State/Territory: North Carolina

AMOUNT, DURATION, AND SCOPE OF MEDICAL AND  
REMEDIAL CARE AND SERVICES PROVIDED TO THE CATEGORICALLY NEEDY

24. Any other medical care and any other type of remedial care recognized under State law, specified by the Secretary.
- a. Transportation.  
 Provided:     No limitations     With limitations\*  
 Not provided.
- b. Services of Christian Science nurses.  
 Provided:     No limitations     With limitations\*  
 Not provided
- c. Care and services provided in Christian Science sanatoria.  
 Provided:     No limitations     With limitations\*  
 Not provided
- d. Nursing facility services for patients under 21 years of age.  
 Provided:     No limitations     With limitations\*  
 Not provided
- e. Emergency hospital services.  
 Provided:     No limitations     With limitations\*  
 Not provided
- f. Personal care services in recipient's home, prescribed in accordance with a plan of treatment and provided by a qualified person under supervision of a registered nurse.  
 Provided:     No limitations     With limitations\*  
 Not provided

\*Description provided on attachment.

State/Territory: North Carolina

Citation

---

**Family Planning Benefits**

1905(a)(4)(C)

**4.c.(i) Family planning services and supplies for individuals of child-bearing age and for individuals eligible pursuant to Att. 2.2-A, B, if this eligibility option is elected by the State.**

Provided:  No limitations  With limitations

Please describe any limitations:

The State of North Carolina will cover a total of six family planning inter-periodic visits annually, not including the annual exam and will cover FDA-approved family planning supplies. Under the State Eligibility Option for Family Planning Services, the State will cover the same family planning services received by all traditional Medicaid beneficiaries.

**4.c.(ii) Family planning-related services provided under the above State Eligibility Option**

Of the six inter-periodic visits allowed under the program, the State of North Carolina will cover medically necessary family planning-related services, pursuant to or in conjunction with an annual exam. Family planning-related services will include screening for HIV, and screening and treatment for sexually-transmitted infections.

State/Territory: North Carolina

AMOUNT, DURATION, AND SCOPE OF MEDICAL AND  
REMEDIAL CARE AND SERVICES PROVIDED TO THE CATEGORICALLY NEEDY

25. Home and Community Care for Functionally Disabled Elderly Individuals, as defined, described and limited in Supplement 2 to Attachment 3.1-A, and Appendices A-G to Supplement 2 to Attachment 3.1-A.

provided  not provided

26. Personal care services furnished to an individual who is not an inpatient or resident of a hospital, nursing facility, intermediate care facility for the mentally retarded, or institution for mental disease that are (A) authorized for the individual by a physician in accordance with a plan of treatment, (B) provided by an individual who is qualified to provide such services and who is not a member of the individual's family, and (C) furnished in a home.

Provided:  State Approved (Not Physician) Service Plan Allowed

Service Outside the Home Also Allowed

Limitations Described on Attachment

Not Provided

27. Program of All-Inclusive Care for the Elderly (PACE) services, as described in Supplement 3 to Attachment 3.1-A.

Election of PACE: By virtue of this submittal, the State elects PACE as an optional State Plan service.

No election of PACE: By virtue of this submittal, the State elects to not add PACE as an optional State Plan service.

**P & I change per State Agency**

Medical Assistance  
State/Territory: North Carolina

---

**Attachment 3.1A: Freestanding Birth Center Services**

**28. (i) Licensed or Otherwise State-Approved Freestanding Birth Centers**

Provided:                      No limitations  With limitations                      None licensed or approved

Please describe any limitations:

Free standing Birth Centers can only bill for vaginal delivery. These centers are subject to all rules and limitations as specified in the Ambulatory Surgical Center section of the State Plan.

**28. (ii) Licensed or Otherwise State-Recognized covered professionals providing services in the Freestanding Birth Center**

Provided:                       No limitations                      With limitations (please describe below)

Not Applicable (there are no licensed or State approved Freestanding Birth Centers)

Please describe any limitations:

Please check all that apply:

(a) Practitioners furnishing mandatory services described in another benefit category and otherwise covered under the State plan (i.e., physicians and certified nurse midwives).

(b) Other licensed practitioners furnishing prenatal, labor and delivery, or postpartum care in a freestanding birth center within the scope of practice under State law whose services are otherwise covered under 42 CFR 440.60 (e.g., lay midwives, certified professional midwives (CPMs), and any other type of licensed midwife). \*

- Physicians
- Physician Assistants
- Certified Nurse Midwives
- Nurse Practitioners

(c) Other health care professionals licensed or otherwise recognized by the State to provide these birth attendant services (e.g., doulas, lactation consultant, etc.).\*

\*For (b) and (c) above, please list and identify below each type of professional who will be providing birth center services:

TN. No. 11-052  
Supersedes  
TN. No. NEW

Approval Date:                      1-20-12

Eff. Date: 10/06/2011

***EDITORIAL NOTE:***

Supplement 1 to Attachment 3.1-A, Parts B, C and D -- Case Management Services for Mentally Ill Adults (Part B), ED Children/Youth (Part C), and Substance Abusers (Part D) were eliminated with the approval of SPA 05-005 on December 29, 2006.

State Plan under Title XIX of the Social Security Act  
State/Territory: North Carolina

---

TARGETED CASE MANAGEMENT SERVICES  
Adults and Children Over 5 Years of Age, or On the CAP-MR/DD Waiver, With Developmental  
Disabilities Or Traumatic Brain Injury

Target Group (42 Code of Federal Regulations 441.18(8)(i) and 441.18(9)):

This target group includes the individuals who meet the following criteria:

Adults and children five years of age and older, or children on the CAP-MR/DD HCBS waiver, who are diagnosed with a developmental disability or diagnosed with mental retardation manifested prior to the age of 22, , or who have mental or physical impairments similar to developmental disabilities as the result of a traumatic brain injury manifested after age 22.

Recipients included in the 1915 c Innovations waiver will be excluded. They will receive coordination of services under 42 CFR 438.208.

Target group includes individuals transitioning to a community setting. Case-management services will be made available for up to 60 consecutive days of a covered stay in a medical institution. Reimbursement is made to the Community Case Management Provider rather than the medical institution. The target group does not include individuals between ages 22 and 64 who are served in Institutions for Mental Disease or individuals who are inmates of public institutions. (State Medicaid Directors Letter (SMDL), July 25, 2000)

Areas of State in which services will be provided (§1915(g)(1) of the Act):

Entire State

Only in the following geographic areas: Recipients with eligibility in the counties covered under Fee for Service Medicaid are eligible for this service.

Comparability of services (§§1902(a)(10)(B) and 1915(g)(1))

Services are provided in accordance with §1902(a)(10)(B) of the Act.

Services are not comparable in amount duration and scope (§1915(g)(1)).

TN# 11-055  
Supersedes  
TN# 10-015

Approval Date: 01/27/12

Effective Date: 10/01/2011



State Plan under Title XIX of the Social Security Act  
State/Territory: North Carolina

---

TARGETED CASE MANAGEMENT SERVICES

Adults and Children Over 5 Years of Age, or On the CAP-MR/DD Waiver, With Developmental Disabilities Or Traumatic Brain Injury

Definition of services (42 CFR 440.169): Targeted case management services are defined as services furnished to assist individuals, eligible under the State Plan, in gaining access to needed medical, social, educational and other services. Targeted Case Management includes the following assistance:

- ❖ Comprehensive assessment and periodic reassessment of individual needs, to determine the need for any medical, educational, social or other services. These assessment activities include:
  - taking client history;
  - identifying the individual's needs and completing related documentation; and
  - gathering information from other sources such as family members, medical providers, social workers, and educators (if necessary), to form a complete assessment of the eligible individual.

The TCM recipient is assessed on an ongoing basis to determine if additional services or different services might be needed and at least annually as a part of the review of the individualized services plan, referred to as the care plan.

- ❖ Development (and periodic revision) of a specific care plan that is based on the information collected through the assessment that:
  - specifies the goals and actions to address the medical, social, educational, and other services needed by the individual;
  - includes activities such as ensuring the active participation of the eligible individual, and working with the individual (or the individual's authorized health care decision maker) and others to develop those goals; and
  - identifies a course of action to respond to the assessed needs of the eligible individual.
- ❖ Referral and related activities (such as scheduling appointments for the individual) to help the eligible individual obtain needed services including,
  - activities that help link the individual with medical, social, educational providers, or other programs and services that are capable of providing needed services to address identified needs and achieve goals specified in the care plan; and

State Plan under Title XIX of the Social Security Act  
State/Territory: North Carolina

---

TARGETED CASE MANAGEMENT SERVICES

Adults and Children Over 5 Years of Age, or On the CAP-MR/DD Waiver, With Developmental Disabilities Or Traumatic Brain Injury

- ❖ Monitoring and follow-up activities:
  - activities and contacts that are necessary to ensure the care plan is implemented and adequately addresses the eligible individual's needs, and which may be with the individual, family members, service providers, or other entities or individuals and conducted as frequently as necessary, and including at least one annual monitoring, to determine whether the following conditions are met:
    - services are being furnished in accordance with the individual's care plan;
    - services in the care plan are adequate; and
    - changes in the needs or status of the individual are reflected in the care plan. Monitoring and follow-up activities include making necessary adjustments in the care plan and service arrangements with providers.

Plans are monitored on at least an annual basis or at any time additional services are needed and requested by or for a recipient. The plan will be reviewed and agreed upon by the recipient, recipient parent or legal representative and case manager.

✕ Case management includes contacts with non-eligible individuals that are directly related to identifying the eligible individual's needs and care, for the purposes of helping the eligible individual access services; identifying needs and supports to assist the eligible individual in obtaining services; providing case managers with useful feedback, and alerting case managers to changes in the eligible individual's needs.

(42 CFR 440.169(e))

Qualifications of providers (42 CFR 441.18(a)(8)(v) and 42 CFR 441.18(b)):

Qualifications for Individual Case Managers: Case Managers under this State Plan must meet one of the following qualifications:

State Plan under Title XIX of the Social Security Act  
State/Territory: North Carolina

---

TARGETED CASE MANAGEMENT SERVICES  
Adults and Children Over 5 Years of Age, or On the CAP-MR/DD Waiver, With Developmental  
Disabilities Or Traumatic Brain Injury

1. A Licensed clinical social worker; or
2. A Licensed psychologist; or
3. A Master's prepared individual with degree in a human service area with one year of experience in case management with the developmentally disabled; A Master's prepared individual with a degree in a human service field, employed by the agency at the time of enrollment, but who does not have one year of experience with public sector case management must meet this experience criteria within one year; or
4. A Bachelor's prepared individual with degree in a human service area with two years of experience in case management with the developmentally disabled; A college prepared individual with a Baccalaureate degree in a human service area that includes the above disciplines, employed by the agency at the time of enrollment, but does not have two years experience with public sector case management must meet this experience criteria within two years; or a Baccalaureate degree in an area other than human services with 4 years of experience in case management with the developmentally disabled.
5. Registered nurse currently licensed by the North Carolina Board of Nursing at the time of enrollment with two years experience with public sector case management; Registered nurse currently licensed by the North Carolina Board of Nursing employed at the time of enrollment but does not have two years experience with public sector case management must meet this experience criteria within two years.

State Plan under Title XIX of the Social Security Act  
State/Territory: North Carolina

---

TARGETED CASE MANAGEMENT SERVICES  
Adults and Children Over 5 Years of Age, or On the CAP-MR/DD Waiver, With Developmental  
Disabilities Or Traumatic Brain Injury

Qualifications for Agency Providers for adults and children five years of age and older or children in the CAP-MR/DD HCBS waiver, who are diagnosed with a developmental delay/disability manifested prior to the age of 22, or diagnosed with mental retardation, or who have mental or physical impairments similar to developmental disabilities as the result of a traumatic brain injury manifested after age 22 shall meet following qualifications.

Provider Agencies providing TCM for persons with Developmental disabilities will include both Local Management Entities (LMEs) and private providers through subcontracting arrangements with LMEs. If Local Management Entities serve as providers, they will be approved by the Division of Mental Health, Developmental Disabilities and Substance Abuse. These provider agencies must have the capacity to assure quality and provide services according to North Carolina laws, policies and regulations.

By August 1, 2010, private providers will be endorsed by the Local Management Entities. Upon provider endorsement, each provider must ensure that each case manager has 20 hours of training relating to case management functions within the first 90 days of hire.

TN# 10-015  
Supersedes  
TN# 05-007

Approval Date: 09-03-10

Effective Date: 07/01/2010

State Plan under Title XIX of the Social Security Act  
State/Territory: North Carolina

---

TARGETED CASE MANAGEMENT SERVICES

Adults and Children Over 5 Years of Age, or On the CAP-MR/DD Waiver, With Developmental Disabilities Or Traumatic Brain Injury

EPSDT: The statewide vendor conducts reviews for consumers under the age of 21, when additional services may be requested even if they do not appear in the State Medicaid Plan or when coverage is limited to those over 21 years of age. Service limitations on scope, amount, or frequency described in the coverage policy may not apply if the service is medically necessary. Any denial, reduction, suspension or termination of a service requires notification to the recipient and/or legal guardian about their appeal rights.

Freedom of choice (42 CFR 441.18(a)(1)):

The State assures that the provision of case management services will not restrict an individual's free choice of providers in violation of section 1902(a)(23) of the Act.

1. Eligible individuals will have free choice of any qualified Medicaid provider within the specified geographic area identified in this plan.
2. Eligible individuals will have free choice of any qualified Medicaid providers of other medical care under the plan.

Freedom of Choice Exception (§1915(g)(1) and 42 CFR 441.18(b)):

**x** Target group consists of eligible individuals with developmental disabilities or with chronic mental illness. Providers are limited to qualified Medicaid providers of case management services capable of ensuring that individuals with developmental disabilities or with chronic mental illness receive needed services.

Targeted Case Management Provider Agencies providing services to this target group must be endorsed by the Local Management Entity by August 1, 2010, as meeting both business and service quality criteria.

State Plan under Title XIX of the Social Security Act  
State/Territory: North Carolina

---

TARGETED CASE MANAGEMENT SERVICES

Adults and Children Over 5 Years of Age, or On the CAP-MR/DD Waiver, With Developmental Disabilities Or Traumatic Brain Injury

Access to Services (42 CFR 441.18(a)(2), 42 CFR 441.18(a)(3), 42 CFR 441.18(a)(6)):

The State assures the following:

- Case management (including targeted case management) services will not be used to restrict an individual's access to other services under the plan.
- Individuals will not be compelled to receive case management services, condition receipt of case management (or targeted case management) services on the receipt of other Medicaid services, or condition receipt of other Medicaid services on receipt of case management (or targeted case management) services; and
- Providers of case management services do not exercise the agency's authority to authorize or deny the provision of other services under the plan.

Payment (42 CFR 441.18(a)(4)):

Payment for case management or targeted case management services under the plan does not duplicate payments made to public agencies or private entities under other program authorities for this same purpose.

Case Records (42 CFR 441.18(a)(7)):

Providers maintain case records that document for all individuals receiving case management as follows: (i) The name of the individual; (ii) The dates of the case management services; (iii) The name of the provider agency (if relevant) and the person providing the case management service; (iv) The nature, content, units of the case management services received and whether goals specified in the care plan have been achieved; (v) Whether the individual has declined services in the care plan; (vi) The need for, and occurrences of, coordination with other case managers; (vii) A timeline for obtaining needed services; (viii) A timeline for reevaluation of the plan.

Limitations:

Case management does not include, and Federal Financial Participation (FFP) is not available in expenditures for, services defined in §441.169 when the case management activities are an integral and inseparable component of another covered Medicaid service (State Medicaid Manual (SMM) 4302.F).

Case management does not include, and Federal Financial Participation (FFP) is not available in expenditures for, services defined in §441.169 when the case management activities constitute the

State Plan under Title XIX of the Social Security Act  
State/Territory: North Carolina

---

TARGETED CASE MANAGEMENT SERVICES  
Adults and Children Over 5 Years of Age, or On the CAP-MR/DD Waiver, With Developmental  
Disabilities Or Traumatic Brain Injury

direct delivery of underlying medical, educational, social, or other services to which an eligible individual has been referred, including for foster care programs, services such as, but not limited to, the following: research gathering and completion of documentation required by the foster care program; assessing adoption placements; recruiting or interviewing potential foster care parents; serving legal papers; home investigations; providing transportation; administering foster care subsidies; making placement arrangements. (42 CFR 441.18(c)).

FFP only is available for case management services or targeted case management services if there are no other third parties liable to pay for such services, including as reimbursement under a medical, social, educational, or other program except for case management that is included in an individualized education program or individualized family service plan consistent with §1903(c) of the Act. (§§1902(a)(25) and 1905(c)).

This service has a limit of one unit per week, with no upper limit on the number of hours per week.

State Plan under Title XIX of the Social Security Act  
State/Territory: North Carolina

---

Intentionally Left Blank

TN# 10-035A  
Supersedes  
TN# 10-015

Approval Date: 03-21-11

Effective Date: 03/01/2011



State Plan under Title XIX of the Social Security Act  
State/Territory: North Carolina

---

Intentionally Left Blank

TN# 10-035A  
Supersedes  
TN# 05-007

Approval Date: 03-21-11

Effective Date: 03/01/2011

State Plan under Title XIX of the Social Security Act  
State/Territory: North Carolina

---

**Intentionally Left Blank**

TN# 10-035A  
Supersedes  
TN# 10-15

Approval Date: 03-21-11

Effective Date: 03/01/2011

State Plan under Title XIX of the Social Security Act  
State/Territory: North Carolina

---

Intentionally Left Blank

TN# 10-035A  
Supersedes  
TN# 10-015

Approval Date: 03-21-11

Effective Date: 03/01/2011

State Plan under Title XIX of the Social Security Act  
State/Territory: North Carolina

---

Intentionally Left Blank

TN# 10-035A  
Supersedes  
TN# 10-015

Approval Date: 03-21-11

Effective Date: 03/01/2011

State Plan under Title XIX of the Social Security Act  
State/Territory: North Carolina

---

**Intentionally Left Blank**

TN# 10-035A  
Supersedes  
TN# 10-015

Approval Date: 03-21-11

Effective Date: 03/01/2011

State Plan under Title XIX of the Social Security Act  
State/Territory: North Carolina

---

Intentionally Left Blank

TN# 10-035A  
Supersedes  
TN# 10-015

Approval Date: 03-21-11

Effective Date: 03/01/2011

State Plan under Title XIX of the Social Security Act  
State/Territory: North Carolina

---

TARGETED CASE MANAGEMENT SERVICES  
Children Less Than Three Years of Age Who Are At Risk For, or Have Been Diagnosed With,  
Developmental Delay/Disability or Social Emotional Disorder

Target Group (42 Code of Federal Regulations 441.18(8)(i) and 441.18(9)):

This target group includes the individuals who meet the requirements defined in the Children's Development Service Agencies policy: Children less than three years of age who are at risk for, or have been diagnosed with, developmental delay/disability or social emotional disorder.

Target group includes individuals transitioning to a community setting. Case-management services will be made available for up to 60 consecutive days of a covered stay in a medical institution or up to 180 days for infants in a neo-natal intensive care unit. Reimbursement is made to the Community Case Management Provider rather than the medical institution.

Areas of State in which services will be provided (§1915(g)(1) of the Act):

- Entire State  
 Only in the following geographic areas: [Specify areas]

Comparability of services (§§1902(a)(10)(B) and 1915(g)(1))

- Services are provided in accordance with §1902(a)(10)(B) of the Act.  
 Services are not comparable in amount duration and scope (§1915(g)(1)).

State Plan under Title XIX of the Social Security Act  
State/Territory: North Carolina

---

TARGETED CASE MANAGEMENT SERVICES  
Children Less Than Three Years of Age Who Are At Risk For, or Have Been Diagnosed With,  
Developmental Delay/Disability or Social Emotional Disorder

Definition of services (42 CFR 440.169): Targeted case management services are defined as services furnished to assist individuals, eligible under the State Plan, in gaining access to needed medical, social, educational and other services. Targeted Case Management includes the following assistance:

- ❖ Comprehensive assessment and periodic reassessment of individual needs, to determine the need for any medical, educational, social or other services. These assessment activities include:
  - taking client history;
  - identifying the individual's needs and completing related documentation; and
  - gathering information from other sources such as family members, medical providers, social workers, and educators (if necessary), to form a complete assessment of the eligible individual.

The TCM recipient is assessed on an ongoing basis to determine if additional services or different services might be needed and at least annually as a part of the review of the individualized services plan, referred to as the care plan.

- ❖ Development (and periodic revision) of a specific care plan that is based on the information collected through the assessment that:
  - specifies the goals and actions to address the medical, social, educational, and other services needed by the individual;
  - includes activities such as ensuring the active participation of the eligible individual, and working with the individual (or the individual's authorized health care decision maker) and others to develop those goals; and
  - identifies a course of action to respond to the assessed needs of the eligible individual.
- ❖ Referral and related activities (such as scheduling appointments for the individual) to help the eligible individual obtain needed services including,
  - activities that help link the individual with medical, social, educational providers, or other programs and services that are capable of providing needed services to address identified needs and achieve goals specified in the care plan; and



State Plan under Title XIX of the Social Security Act  
State/Territory: North Carolina

---

TARGETED CASE MANAGEMENT SERVICES

Children Less Than Three Years of Age Who Are At Risk For, or Have Been Diagnosed With,  
Developmental Delay/Disability or Social Emotional Disorder

- ❖ Monitoring and follow-up activities:
  - activities and contacts that are necessary to ensure the care plan is implemented and adequately addresses the eligible individual's needs, and which may be with the individual, family members, service providers, or other entities or individuals and conducted as frequently as necessary, and including at least one annual monitoring, to determine whether the following conditions are met:
    - services are being furnished in accordance with the individual's care plan;
    - services in the care plan are adequate; and
    - changes in the needs or status of the individual are reflected in the care plan.

Monitoring and follow-up activities include making necessary adjustments in the care plan and service arrangements with providers.

Plans are monitored on at least an annual basis or at any time additional services are needed and requested by or for a recipient. The plan will be reviewed and agreed upon by the recipient, recipient parent or legal representative and case manager.

✕ Case management includes contacts with non-eligible individuals that are directly related to identifying the eligible individual's needs and care, for the purposes of helping the eligible individual access services; identifying needs and supports to assist the eligible individual in obtaining services; providing case managers with useful feedback, and alerting case managers to changes in the eligible individual's needs.

(42 CFR 440.169(e))

Qualifications of providers (42 CFR 441.18(a)(8)(v) and 42 CFR 441.18(b)):

Provider agencies are certified by the North Carolina Division of Public Health, Early Intervention Branch as having in-depth knowledge, experience and understanding of the special populations of infants and children who are in this defined target population.

State Plan under Title XIX of the Social Security Act  
State/Territory: North Carolina

---

TARGETED CASE MANAGEMENT SERVICES  
Children Less Than Three Years of Age Who Are At Risk for, or Have Been Diagnosed With,  
Developmental Delay/Disability or Social Emotional Disorder

Qualifications for case managers are established by the Division of Public Health, Early Intervention Branch. They are as follows:

1. Case managers for an infant or toddler, referred to or enrolled in the Early Intervention Program, shall meet *one* of the following qualifications regarding degree held:
  - Hold a master's degree from an accredited university in a health, education, early childhood, or human services field.
  - Hold a current North Carolina license in nursing, regardless of whether a two, three, or four-year educational program.
  - Be an infant or toddler's case manager who is working with children and families under the supervision of a Case Management Supervisor as defined below to conduct those case management activities that they have been approved to perform.
2. An infant or toddler's case manager must be approved through the certification process of the Division of Public Health Early Intervention Branch for the NC Infant-Toddler Program.
3. A Case Management Supervisor shall meet *one* of the following qualifications regarding degree held:
  - Hold a master's degree from an accredited university in a health, education, early childhood, or human services field; or
  - Hold a bachelor's degree from an accredited university in a health, education, early childhood, or human services field and have a minimum of two years of experience in providing services to infants or toddlers with or at risk for developmental delays.
4. A Case Management Supervisor must be approved through the certification process of the Division of Public Health Early Intervention Branch for the NC Infant-Toddler Program.
5. Certification Process. The Division of Medical Assistance has adopted the Division of Public Health, Infant Toddler Program standards and procedures for certification of each individual case manager. This certification process assures:
  - a. Their capacity to provide case management services.
  - b. Their experience with delivery and/or coordination of services for children and families.

TN# 10-015  
Supersedes  
TN# NEW

Approval Date: 09-03-10

Effective Date: 07/01/2010

State Plan under Title XIX of the Social Security Act  
State/Territory: North Carolina

---

TARGETED CASE MANAGEMENT SERVICES

Children Less Than Three Years of Age Who Are At Risk for, or Have Been Diagnosed With,  
Developmental Delay/Disability or Social Emotional Disorder

EPSDT: The statewide vendor conducts reviews for consumers under the age of 21, when additional services may be requested even if they do not appear in the State Medicaid Plan or when coverage is limited to those over 21 years of age. Service limitations on scope, amount, or frequency described in the coverage policy may not apply if the service is medically necessary. Any denial, reduction, suspension or termination of a service requires notification to the recipient and/or legal guardian about their appeal rights.

Freedom of choice (42 CFR 441.18(a)(1)):

The State assures that the provision of case management services will not restrict an individual's free choice of providers in violation of section 1902(a)(23) of the Act.

3. Eligible individuals will have free choice of any qualified Medicaid provider within the specified geographic area identified in this plan.
4. Eligible individuals will have free choice of any qualified Medicaid providers of other medical care under the plan.

Freedom of Choice Exception (§1915(g)(1) and 42 CFR 441.18(b)):

**X** Target group consists of eligible individuals with developmental disabilities or with chronic mental illness. Providers are limited to qualified Medicaid providers of case management services capable of ensuring that individuals with developmental disabilities or with chronic mental illness receive needed services.

TCM Provider Agencies must be certified by the Division of Public Health as meeting both business and service quality criteria.

State Plan under Title XIX of the Social Security Act  
State/Territory: North Carolina

---

TARGETED CASE MANAGEMENT SERVICES  
Children Less Than Three Years of Age Who Are At Risk For, or Have Been Diagnosed With,  
Developmental Delay/Disability or Social Emotional Disorder

Access to Services (42 CFR 441.18(a)(2), 42 CFR 441.18(a)(3), 42 CFR 441.18(a)(6)):

The State assures the following:

- Case management (including targeted case management) services will not be used to restrict an individual's access to other services under the plan.
- Individuals will not be compelled to receive case management services, condition receipt of case management (or targeted case management) services on the receipt of other Medicaid services, or condition receipt of other Medicaid services on receipt of case management (or targeted case management) services; and
- Providers of case management services do not exercise the agency's authority to authorize or deny the provision of other services under the plan.

Payment (42 CFR 441.18(a)(4)):

Payment for case management or targeted case management services under the plan does not duplicate payments made to public agencies or private entities under other program authorities for this same purpose.

Case Records (42 CFR 441.18(a)(7)):

Providers maintain case records that document for all individuals receiving case management as follows: (i) The name of the individual; (ii) The dates of the case management services; (iii) The name of the provider agency (if relevant) and the person providing the case management service; (iv) The nature, content, units of the case management services received and whether goals specified in the care plan have been achieved; (v) Whether the individual has declined services in the care plan; (vi) The need for, and occurrences of, coordination with other case managers; (vii) A timeline for obtaining needed services; (viii) A timeline for reevaluation of the plan.

Limitations:

Case management does not include, and Federal Financial Participation (FFP) is not available in expenditures for, services defined in §441.169 when the case management activities are an integral and inseparable component of another covered Medicaid service (State Medicaid Manual (SMM) 4302.F).

State Plan under Title XIX of the Social Security Act  
State/Territory: North Carolina

---

TARGETED CASE MANAGEMENT SERVICES  
Children Less Than Three Years of Age Who Are At Risk For, or Have Been Diagnosed With,  
Developmental Delay/Disability or Social Emotional Disorder

Case management does not include, and Federal Financial Participation (FFP) is not available in expenditures for, services defined in §441.169 when the case management activities constitute the direct delivery of underlying medical, educational, social, or other services to which an eligible individual has been referred, including for foster care programs, services such as, but not limited to, the following: research gathering and completion of documentation required by the foster care program; assessing adoption placements; recruiting or interviewing potential foster care parents; serving legal papers; home investigations; providing transportation; administering foster care subsidies; making placement arrangements. (42 CFR 441.18(c)).

FFP only is available for case management services or targeted case management services if there are no other third parties liable to pay for such services, including as reimbursement under a medical, social, educational, or other program except for case management that is included in an individualized education program or individualized family service plan consistent with §1903(c) of the Act. (§§1902(a)(25) and 1905(c)).

This service is limited to 12 units or three hours per month.

State Plan under Title XIX of the Social Security Act  
State/Territory: North Carolina

PAGE INTENTIONALLY LEFT BLANK

TN# 10-035A  
Supersedes  
TN# 09-020

Approval Date: 03-21-11

Effective Date 03/01/2011

State Plan under Title XIX of the Social Security Act  
State/Territory: North Carolina

PAGE INTENTIONALLY LEFT BLANK

TN# 10-035A  
Supersedes  
TN# 09-020

Approval Date: 03-21-11

Effective Date 03/01/2010

State Plan under Title XIX of the Social Security Act  
State/Territory: North Carolina

PAGE INTENTIONALLY LEFT BLANK

TN# 10-035A  
Supersedes  
TN# 09-020

Approval Date: 03-21-11

Effective Date 03/01/2011



State Plan under Title XIX of the Social Security Act  
State/Territory: North Carolina

PAGE INTENTIONALLY LEFT BLANK

TN# 10-035A  
Supersedes  
TN# 09-020

Approval Date: 03-21-11

Effective Date 03/01/2011

State Plan under Title XIX of the Social Security Act  
State/Territory: North Carolina

PAGE INTENTIONALLY LEFT BLANK

TN# 10-035A  
Supersedes  
TN# 09-020

Approval Date: 03-21-11

Effective Date 03/01/2011

State Plan under Title XIX of the Social Security Act  
State/Territory: North Carolina

TARGETED CASE MANAGEMENT SERVICES  
[Individuals with Mental Illness/Substance Use Disorders]

Target Group (42 Code of Federal Regulations 441.18(8)(i) and 441.18(9)):

In order to receive services, the individual must meet the defined entrance criteria.

1. (For recipients age 3 through 20): Has a serious emotional disturbance or substance use disorder.
2. (For recipients 21 and older) Has a severe and persistent mental illness or a substance use disorder.

X Target group includes individuals transitioning to a community setting. Case-management services will be made available for up to 60 consecutive days of a covered stay in a medical institution. Reimbursement is made to community case management providers rather than the medical institution, for these activities. The target group does not include individuals between ages 22 and 64 who are served in Institutions for Mental Disease or individuals who are inmates of public institutions). (State Medicaid Directors Letter (SMDL), July 25, 2000)

Areas of State in which services will be provided (§1915(g)(1) of the Act):

- Entire State
- X Only in the following geographic areas: Recipients included in the 1915(b) North Carolina MH/DD/SA Health Plan will be excluded. They will receive coordination of services under 42 CFR 438.208.

Comparability of services (§§1902(a)(10)(B) and 1915(g)(1))

- Services are provided in accordance with §1902(a)(10)(B) of the Act.
- X Services are not comparable in amount duration and scope (§1915(g)(1)).

Definition of services (42 CFR 440.169): Targeted case management services are defined as services furnished to assist individuals, eligible under the State Plan, in gaining access to needed medical, social, educational and other services. Targeted Case Management includes the following assistance:

- ❖ Comprehensive assessment and periodic reassessment of individual needs, to determine the need for any medical, educational, social or other services. These assessment activities include
  - taking client history;
  - identifying the individual's needs and completing related documentation; and
  - gathering information from other sources such as family members, medical providers, social workers, and educators (if necessary), to form a complete assessment of the eligible individual;

The TCM recipient is assessed on an ongoing basis to determine if additional services or different services might be needed and at least annually as a part of the review of the individualized services plan, referred to as the Person Centered Plan.

---

TN# 11-011  
Supersedes  
TN# 10-007

Approval Date: 07/29/11

Effective Date 07/1/2011

State Plan under Title XIX of the Social Security Act  
State/Territory: North Carolina

TARGETED CASE MANAGEMENT SERVICES  
[Individuals with Mental Illness/Substance Use Disorders]

- ❖ Development (and periodic revision) of a specific care plan that is based on the information collected through the assessment that
  - specifies the goals and actions to address the medical, social, educational, and other services needed by the individual;
  - includes activities such as ensuring the active participation of the eligible individual, and working with the individual (or the individual's authorized health care decision maker) and others to develop those goals; and
  - identifies a course of action to respond to the assessed needs of the eligible individual;
- ❖ Referral and related activities (such as scheduling appointments for the individual) to help the eligible individual obtain needed services including
  - activities that help link the individual with medical, social, educational providers, or other programs and services that are capable of providing needed services to address identified needs and achieve goals specified in the care plan; and
- ❖ Monitoring and follow-up activities:
  - activities and contacts that are necessary to ensure the care plan is implemented and adequately addresses the eligible individual's needs, and which may be with the individual, family members, service providers, or other entities or individuals and conducted as frequently as necessary, and including at least one annual monitoring, to determine whether the following conditions are met:
    - services are being furnished in accordance with the individual's care plan;
    - services in the care plan are adequate; and
    - changes in the needs or status of the individual are reflected in the care plan. Monitoring and follow-up activities include making necessary adjustments in the care plan and service arrangements with providers.

Plans are monitored on at least an annual basis or at any time additional services are needed and requested by or for a recipient. The plan will be reviewed and agreed upon by the recipient, recipient parent or legal representative and case manager.

Case management includes contacts with non-eligible individuals that are directly related to identifying the eligible individual's needs and care, for the purposes of helping the eligible individual access services; identifying needs and supports to assist the eligible individual in obtaining services; providing case managers with useful feedback, and alerting case managers to changes in the eligible individual's needs. (42 CFR 440.169(e))

State Plan under Title XIX of the Social Security Act  
State/Territory: North Carolina

TARGETED CASE MANAGEMENT SERVICES  
[Individuals with Mental Illness/Substance Use Disorders]

Qualifications of providers (42 CFR 441.18(a)(8)(v) and 42 CFR 441.18(b)):

To provide TCM for persons with mental illness or substance use disorder, provider agencies must be certified as a Critical Access Behavioral Health Agency (CABHA). These provider agencies must have the capacity to assure quality and provide services according to North Carolina laws, policies and regulations. CABHAs will be certified by the DHHS and Local Management Entities (LMEs). Each provider must ensure that each case manager completes DHHS-approved targeted case management training within the first 90 days of hire.

Qualifications for Individual Case Managers: Case Managers under this State Plan must meet one of the following qualifications based on the target population being served:

1. currently licensed by the appropriate North Carolina licensure board as a Licensed Clinical Addiction Specialist, Licensed Clinical Social Worker, Licensed Marriage and Family Therapist, Licensed Professional Counselor, Psychiatrist, Licensed Psychologist or a Licensed Psychological Associate or;
2. a graduate of a college or university with a Masters degree in a human service field and has one year of full-time, post-graduate degree accumulated MH/DD/SAS experience with the population served or a substance abuse professional who has one year of full-time, post-graduate degree accumulated supervised experience in alcoholism and drug abuse counseling or;
3. a graduate of a college or university with a bachelor's degree in a human service field or an RN currently licensed by the NC Board of Nursing and has four years of full-time, post-bachelor's degree accumulated MH/DD/SAS experience with the population served, or a substance abuse professional who has two years of full-time, post-graduate degree accumulated supervised experience in alcoholism and drug abuse counseling or;

---

TN# 10-007  
Supersedes  
TN# NEW

Approval Date: 07/16/10

Effective Date: 07/01/2010

State Plan under Title XIX of the Social Security Act  
State/Territory: North Carolina

TARGETED CASE MANAGEMENT SERVICES  
[Individuals with Mental Illness/Substance Use Disorders]

4. a graduate of a college or university with a bachelor's degree in a field other than human services and has four years of full-time, post-bachelor's degree accumulated MH/DD/SAS experience with the population served, or a substance abuse professional who has four years of full-time, post-graduate degree accumulated supervised experience in alcoholism and drug abuse counseling.

\*Degrees in a human service field include but are not limited to, the following degrees: psychology, social work, mental health counseling, rehabilitation counseling, addictions, psychiatric nursing, special education, and therapeutic recreation.

Freedom of choice (42 CFR 441.18(a)(1):

The State assures that the provision of case management services will not restrict an individual's free choice of providers in violation of section 1902(a)(23) of the Act.

5. Eligible individuals will have free choice of any qualified Medicaid provider within the specified geographic area identified in this plan.
6. Eligible individuals will have free choice of any qualified Medicaid providers of other medical care under the plan.

Freedom of Choice Exception (§1915(g)(1) and 42 CFR 441.18(b)):

X Target group consists of eligible individuals with mental illness or substance use disorders. Providers are limited to qualified Medicaid providers of case management services capable of ensuring that individuals with mental illness or substance use disorders receive needed services:

For this target population, Targeted Case Management Provider Agencies must be certified as Critical Access Behavioral Health Agencies (CABHAs) by DHHS and Local Management Entities (LMEs).

Access to Services (42 CFR 441.18(a)(2), 42 CFR 441.18(a)(3), 42 CFR 441.18(a)(6):

The State assures the following:

- Case management (including targeted case management) services will not be used to restrict an individual's access to other services under the plan.
- Individuals will not be compelled to receive case management services, condition receipt of case management (or targeted case management) services on the receipt of other Medicaid services, or condition receipt of other Medicaid services on receipt of case management (or targeted case management) services; and
- Providers of case management services do not exercise the agency's authority to authorize or deny the provision of other services under the plan.

State Plan under Title XIX of the Social Security Act  
State/Territory: North Carolina

TARGETED CASE MANAGEMENT SERVICES  
[Individuals with Mental Illness/Substance Use Disorders]

Payment (42 CFR 441.18(a)(4)):

Payment for case management or targeted case management services under the plan does not duplicate payments made to public agencies or private entities under other program authorities for this same purpose.

Case Records (42 CFR 441.18(a)(7)):

Providers maintain case records that document for all individuals receiving case management as follows: (i) The name of the individual; (ii) The dates of the case management services; (iii) The name of the provider agency (if relevant) and the person providing the case management service; (iv) The nature, content, units of the case management services received and whether goals specified in the care plan have been achieved; (v) Whether the individual has declined services in the care plan; (vi) The need for, and occurrences of, coordination with other case managers; (vii) A timeline for obtaining needed services; (viii) A timeline for reevaluation of the plan.

Limitations:

Case management does not include, and Federal Financial Participation (FFP) is not available in expenditures for, services defined in §441.169 when the case management activities are an integral and inseparable component of another covered Medicaid service (State Medicaid Manual (SMM)) 4302.F).

Case management does not include, and Federal Financial Participation (FFP) is not available in expenditures for, services defined in §441.169 when the case management activities constitute the direct delivery of underlying medical, educational, social, or other services to which an eligible individual has been referred, including for foster care programs, services such as, but not limited to, the following: research gathering and completion of documentation required by the foster care program; assessing adoption placements; recruiting or interviewing potential foster care parents; serving legal papers; home investigations; providing transportation; administering foster care subsidies; making placement arrangements. (42 CFR 441.18(c))

FFP only is available for case management services or targeted case management services if there are no other third parties liable to pay for such services, including as reimbursement under a medical, social, educational, or other program except for case management that is included in an individualized education program or individualized family service plan consistent with §1903(c) of the Act. (§§1902(a)(25) and 1905(c))

Case management services may be provided by only a provider agency that is a certified Critical Access Behavioral Health Agency (CABHA). An individual may receive case management services from only one CABHA during any active authorization period for this service.

State Plan under Title XIX of the Social Security Act  
State/Territory: North Carolina

TARGETED CASE MANAGEMENT SERVICES  
[Individuals with Mental Illness/Substance Use Disorders]

In situations where more than one recipient within a family qualifies for MH/SA Targeted Case Management and the family has chosen the same CABHA, that CABHA shall assign the same case manager to serve each recipient in the family only as long as that case manager has the required qualifications to serve both populations and is clinically appropriate.

The following are not billable under this service:

- Transportation time
- Transportation services
- Any treatment interventions (for example, habilitation or rehabilitation activities)
- Any social or recreational activities (or the supervision thereof)
- Clinical and administrative supervision of staff, including team meetings
- Writing assessment reports, Person Centered Plans, or service notes
- Service record reviews

Service delivery to individuals other than the recipient(s) may be covered only when the activity is directed exclusively toward the benefit of the recipient(s).

Case Management services can be provided for two weeks during the same authorization period as the following services for transition purposes: Intensive In-Home Services, Community Support Team, Assertive Community Treatment Team, Multisystemic Therapy, Child and Adolescent Day Treatment, Substance Abuse Intensive Outpatient Program, Substance Abuse Comprehensive Outpatient Treatment, or Substance Abuse Non-Medical Community Residential Treatment.

Medicaid recipients receiving MH/SA case management may not receive other Medicaid-reimbursable case management services during the same period, including but not limited to the following:

- Community Alternatives Program (CAP), including CAP for Disabled Adults (CAP/DA), CAP for Children (CAP/C), CAP for Individuals with Mental Retardation or Developmental Disabilities (CAP/MR-DD) or CAP Choice.
- Targeted Case Management for Individuals with Mental Retardation/Developmental Disabilities (MR/DD)

Service is limited to one unit per week.



State Plan under Title XIX of the Social Security Act  
State/Territory: North Carolina

TARGETED CASE MANAGEMENT SERVICES

ADULTS AND CHILDREN AT-RISK OF ABUSE, NEGLECT, OR EXPLOITATION

Target Group (42 Code of Federal Regulations 441.18(8)(i) and 441.18(9)):

The target group includes Medicaid recipients who are assessed as at-risk of abuse, neglect, or exploitation as defined in North Carolina General Statutes 7B-101 and 108A-101 *and who meet requirements defined in the At Risk Case Management policy.*

The recipient cannot be institutionalized nor a recipient of other Medicaid-reimbursed case management services provided through the State's home and community-based services waivers or the State Plan. The at risk case manager assesses risk using a State prescribed format. The criteria for determining whether an adult or child is at risk of abuse, neglect, or exploitation is as follows:

1. At-Risk Adult: An at-risk adult is an individual who is at least 18 years old, or an emancipated minor, and meets one or more of the following criteria:
  - a. An individual with only one consistent identified caregiver, who needs personal assistance 24 hours per day with two or more of the activities of daily living (bathing, dressing, grooming, toileting, transferring, ambulating, eating, communicating); or
  - b. An individual with no consistent identified caregiver, who is unable to perform at least one of the activities of daily living (bathing, dressing, grooming, toileting, transferring, ambulating, eating, communicating); or
  - c. An individual with no consistent identified caregiver, who is unable to carry out instrumental activities of daily living (managing financial affairs, shopping, housekeeping, laundry, meal preparation, using transportation, using a telephone, reading, writing); or
  - d. An individual who was previously abused, neglected or exploited, and the conditions leading to the previous incident continue to exist; or
  - e. An individual who is being abused, neglected, or exploited and the need for protective services is substantiated.
  
2. At-Risk Child: An at-risk child is an individual under 18 years of age who meets one or more of the following criteria:
  - a. A child with a chronic or severe physical or mental condition whose parent(s) or caretaker(s) are unable or unwilling to meet the child's care needs or whose adoptive parents needs assistance in order to meet the child's care needs; or

State Plan under Title XIX of the Social Security Act  
State/Territory: North Carolina

TARGETED CASE MANAGEMENT SERVICES

ADULTS AND CHILDREN AT-RISK OF ABUSE, NEGLECT, OR EXPLOITATION

- b. A child whose parents are mentally or physically impaired to the extent that there is a need for assistance with maintaining family stability and preventing or remedying problems which may result in abuse or neglect of the child; or
- c. A child of adolescent (under age 18) parents or parents who has their first child when either parent was an adolescent and there is a need for assistance with maintaining family stability, strengthening individual support systems, and preventing or remedying problems which may result in abuse or neglect of the child; or
- d. A child who was previously abused or neglected, and the conditions leading to the previous incident continue to exist; or
- e. A child who is being abused or neglected and the need for protective services is substantiated.

\_\_\_ The target group includes individuals transitioning to a community setting. Case-management services will be made available for up to \_\_\_\_\_ [insert a number; not to exceed 180] consecutive days of a covered stay in a medical institution. The target group does not include individuals between ages 22 and 64 who are served in Institutions for Mental Disease or individuals who are inmates of public institutions). (State Medicaid Directors Letter (SMDL), July 25, 2000)

Areas of State in which services will be provided (§1915(g)(1) of the Act):

- Entire State
- \_\_\_ Only in the following geographic areas: [Specify areas]

Comparability of services (§§1902(a)(10)(B) and 1915(g)(1))

- \_\_\_ Services are provided in accordance with §1902(a)(10)(B) of the Act.
- Services are not comparable in amount duration and scope (§1915(g)(1)).

Definition of services (42 CFR 440.169): Targeted case management services are defined as services furnished to assist individuals, eligible under the State Plan, in gaining access to needed medical, social, educational and other services. Targeted Case Management includes the following assistance:

- ❖ Comprehensive assessment and periodic reassessment of individual needs, to determine the need for any medical, educational, social or other services. These assessment activities include
  - taking client history;

State Plan under Title XIX of the Social Security Act  
State/Territory: North Carolina

TARGETED CASE MANAGEMENT SERVICES

ADULTS AND CHILDREN AT-RISK OF ABUSE, NEGLECT, OR EXPLOITATION

- identifying the individual's needs and completing related documentation; and
- gathering information from other sources such as family members, medical providers, social workers, and educators (if necessary), to form a complete assessment of the eligible individual;

An initial assessment is conducted to determine the individual's need for medical, education, social, and other services. The continuing appropriateness of providing At Risk Case Management Services is assessed during quarterly reviews of the service plan. Reassessments are completed annually which include performing a new assessment and creating a new service plan.

- ❖ Development (and periodic revision) of a specific care plan that is based on the information collected through the assessment that
  - specifies the goals and actions to address the medical, social, educational, and other services needed by the individual;
  - includes activities such as ensuring the active participation of the eligible individual, and working with the individual (or the individual's authorized health care decision maker) and others to develop those goals; and
  - identifies a course of action to respond to the assessed needs of the eligible individual;
- ❖ Referral and related activities (such as scheduling appointments for the individual) to help the eligible individual obtain needed services including
  - activities that help link the individual with medical, social, educational providers, or other programs and services that are capable of providing needed services to address identified needs and achieve goals specified in the care plan; and
- ❖ Monitoring and follow-up activities:
  - activities and contacts that are necessary to ensure the care plan is implemented and adequately addresses the eligible individual's needs, and which may be with the individual, family members, service providers, or other entities or individuals and conducted as frequently as necessary, and including at least one annual monitoring, to determine whether the following conditions are met:
    - services are being furnished in accordance with the individual's care plan;
    - services in the care plan are adequate; and
    - changes in the needs or status of the individual are reflected in the care plan. Monitoring and follow-up activities include making necessary adjustments in the care plan and service arrangements with providers.

State Plan under Title XIX of the Social Security Act  
State/Territory: North Carolina

TARGETED CASE MANAGEMENT SERVICES

ADULTS AND CHILDREN AT-RISK OF ABUSE, NEGLECT, OR EXPLOITATION

- Follow up visits are conducted quarterly unless there is a change in the individual's condition. These contacts with the individual subsequent to the initial assessment must be one-on-one, face-to-face visits. It is necessary to contact the individual at least quarterly to ensure that there are not any new concerns or changes in the status of previously identified concerns. In addition, these contacts are necessary to ensure that the care plan is effectively implemented and is consistent with quality of care.

X At risk case management includes contacts with non-eligible individuals that are directly related to identifying the eligible individual's needs and care, for the purposes of helping the eligible individual access services; identifying needs and supports to assist the eligible individual in obtaining services; providing case managers with useful feedback, and alerting case managers to changes in the eligible individual's needs.  
(42 CFR 440.169(e))

Qualifications of providers (42 CFR 441.18(a)(8)(v) and 42 CFR 441.18(b)):

1. Provider Qualifications

Providers must meet the following qualifications:

- Meet applicable State and Federal laws governing the participation of providers in the Medicaid Program.
- Be certified by the Division of Aging and Adult Services as a qualified At Risk Case Management Provider.

2. Certification Process

In the absence of State licensure laws governing the qualifications and standards of practice of providers of case management services for at-risk adults and children, the State Division of Medical Assistance and the State Division of Social Services and the State Division of Aging and Adult Services have a Memorandum of Understanding to provide a certification process. The State Division of Aging and Adult Services agrees to implement methods and procedures for certifying providers of At Risk Case Management services as qualified to render services according to professionally recognized standards for quality care. This will help assure that case management services are provided by qualified providers

To be certified as an At Risk Case Manager, a provider must:

- Have qualified case managers with supervision provided by a supervisor who meets State requirements for Social Work Supervisor I or Social Work Supervisor II classification.

State Plan under Title XIX of the Social Security Act  
State/Territory: North Carolina

TARGETED CASE MANAGEMENT SERVICES

ADULTS AND CHILDREN AT-RISK OF ABUSE, NEGLECT, OR EXPLOITATION

- Case Manager for At-Risk Adults: A case manager for at-risk adults must have a Master of Social Work degree or a Bachelor of Social Work degree, or be a social worker who meets State Requirements for Social Worker II classification. The individual must have training in recognizing risk factors related to abuse, neglect, or exploitation of elderly or disabled adults and in assessment of functional capacity and needs related to activities of daily living. The individual must have experience in providing case management for elderly and disabled adults.
- Case Manager for At-Risk Children: A case manager for at-risk children must have a Master of Social Work degree or a Bachelor of Social Work degree, or be a social worker who meets State requirements for Social Worker II classification. The individual must also have training in recognizing risk factors related to abuse or neglect of children and in assessing family functioning. The individual must have experience in providing case management for children and their families.
- Have the capability to access multi-disciplinary staff, when needed. For adults this includes, at a minimum, medical professionals as needed and an adult protective services social worker. For children, this includes, at a minimum, medical professionals as needed and a child protective services social worker.
- Have experience as a legal guardian of persons and property.

Freedom of choice (42 CFR 441.18(a)(1):

The State assures that the provision of at risk case management services will not restrict an individual's free choice of providers in violation of section 1902(a)(23) of the Act.

7. Eligible individuals will have free choice of any qualified Medicaid provider within the specified geographic area identified in this plan.
8. Eligible individuals will have free choice of any qualified Medicaid providers of other medical care under the plan.

Freedom of Choice Exception (§1915(g)(1) and 42 CFR 441.18(b)):

\_\_\_\_ This target group consists of eligible individuals with developmental disabilities or with chronic mental illness. Providers are limited to qualified Medicaid providers of targeted case management services capable of ensuring that individuals with developmental disabilities or with chronic mental illness receive needed services: [Identify any limitations to be imposed on the providers and specify how these limitations enable providers to ensure that individuals within the target groups receive needed services.]

State Plan under Title XIX of the Social Security Act  
State/Territory: North Carolina

TARGETED CASE MANAGEMENT SERVICES

ADULTS AND CHILDREN AT-RISK OF ABUSE, NEGLECT, OR EXPLOITATION

Access to Services (42 CFR 441.18(a)(2), 42 CFR 441.18(a)(3), 42 CFR 441.18(a)(6):

The State assures the following:

- Case management (including targeted case management) services will not be used to restrict an individual's access to other services under the plan.
- Individuals will not be compelled to receive case management services, condition receipt of case management (or targeted case management) services on the receipt of other Medicaid services, or condition receipt of other Medicaid services on receipt of case management (or targeted case management) services; and
- Providers of case management services do not exercise the agency's authority to authorize or deny the provision of other services under the plan.

EPSDT: Reviews are conducted for consumers under the age of 21, when additional services may be requested even if they do not appear in the State Medicaid Plan or when coverage is limited to those over 21 years of age. Service limitations on scope, amount, or frequency described in the coverage policy may not apply if the service is medically necessary. Any denial, reduction, suspension or termination of a service requires notification to the recipient and/or legal guardian about their appeal rights.

Payment (42 CFR 441.18(a)(4):

Payment for case management or at risk case management services under the plan does not duplicate payments made to public agencies or private entities under other program authorities for this same purpose.

Case Records (42 CFR 441.18(a)(7)):

Providers maintain case records that document for all individuals receiving at risk case management as follows: (i) The name of the individual; (ii) The dates of the case management services; (iii) The name of the provider agency (if relevant) and the person providing the at risk case management service; (iv) The nature, content, units of the at risk case management services received and whether goals specified in the care plan have been achieved; (v) Whether the individual has declined services in the care plan; (vi) The need for, and occurrences of, coordination with other case managers; (vii) A timeline for obtaining needed services; (viii) A timeline for reevaluation of the plan.

Limitations:

At risk case management does not include, and Federal Financial Participation (FFP) is not available in expenditures for, services defined in §441.169 when the case management activities are an integral and inseparable component of another covered Medicaid service (State Medicaid Manual (SMM) 4302.F).

State Plan under Title XIX of the Social Security Act  
State/Territory: North Carolina

TARGETED CASE MANAGEMENT SERVICES

ADULTS AND CHILDREN AT-RISK OF ABUSE, NEGLECT, OR EXPLOITATION

At risk case management does not include, and Federal Financial Participation (FFP) is not available in expenditures for, services defined in §441.169 when the at risk case management activities constitute the direct delivery of underlying medical, educational, social, or other services to which an eligible individual has been referred, including for foster care programs, services such as, but not limited to, the following: research gathering and completion of documentation required by the foster care program; assessing adoption placements; recruiting or interviewing potential foster care parents; serving legal papers; home investigations; providing transportation; administering foster care subsidies; making placement arrangements. (42 CFR 441.18(c)).

FFP only is available for At risk case management services or targeted case management services if there are no other third parties liable to pay for such services, including as reimbursement under a medical, social, educational, or other program except for case management that is included in an individualized education program or individualized family service plan consistent with §1903(c) of the Act. (§§1902(a)(25) and 1905(c))

State Plan under Title XIX of the Social Security Act  
State/Territory: North Carolina  
TARGETED CASE MANAGEMENT SERVICES  
Persons with HIV Disease

Target Group (42 Code of Federal Regulations 441.18(8)(i) and 441.18(9)):

The target group includes individuals below who meet the requirements defined in the HIV Case Management policy:

1. Have a medical diagnosis of HIV disease; or
2. Have a medical diagnosis of HIV seropositivity; and
3. Are eligible for regular Medicaid services; and
4. Are not institutionalized; and
5. Are not recipients of other Medicaid-reimbursed case management services, including those provided through the State's home and community-based services waivers or the State Plan.

\_\_\_ Target group includes individuals transitioning to a community setting. Case-management services will be made available for up to \_\_\_\_\_ [insert a number; not to exceed 180] consecutive days of a covered stay in a medical institution. The target group does not include individuals between ages 22 and 64 who are served in Institutions for Mental Disease or individuals who are inmates of public institutions). (State Medicaid Directors Letter (SMDL), July 25, 2000)

Areas of State in which services will be provided (§1915(g)(1) of the Act):

- Entire State  
\_\_\_ Only in the following geographic areas: [Specify areas]

Comparability of services (§§1902(a)(10)(B) and 1915(g)(1))

- \_\_\_ Services are provided in accordance with §1902(a)(10)(B) of the Act.  
 Services are not comparable in amount duration and scope (§1915(g)(1)).

Definition of services (42 CFR 440.169): Targeted case management services are defined as services furnished to assist individuals, eligible under the State Plan, in gaining access to needed medical, social, educational and other services. Targeted Case Management includes the following assistance:

- ❖ Comprehensive assessment and periodic reassessment of individual needs, to determine the need for any medical, educational, social or other services. These assessment activities include
  - taking client history;
  - identifying the individual's needs and completing related documentation; and
  - gathering information from other sources such as family members, medical providers, social workers, and educators (if necessary), to form a complete assessment of the eligible individual;

TN# 08-020  
Supersedes  
TN# 94-01

Approval Date: 03-10-10

Effective Date 10/01/2009



State Plan under Title XIX of the Social Security Act  
State/Territory: North Carolina  
TARGETED CASE MANAGEMENT SERVICES  
Persons with HIV Disease

HIV case managers shall conduct a comprehensive assessment and evaluate the individual's need for initial case management services. The reassessment shall be conducted on an annual basis. The assessment shall include observation of the recipient's physical appearance and behavior during the interview; and gathering the individual's history, obtaining information from other sources such as family members, medical providers, social workers and educators. The assessment shall address the following:

- coordination and follow-up of medical treatments;
  - provision of treatment adherence education;
  - physical needs to include activities of daily living and instrumental activities of daily living;
  - mental health/substance abuse/developmental disability needs;
  - housing and unmet needs related to physical environment;
  - financial needs; and
  - socialization and recreational needs.
- ❖ Development (and periodic revision) of a specific care plan that is based on the information collected through the assessment that
- specifies the goals and actions to address the medical, social, educational, and other services needed by the individual;
  - includes activities such as ensuring the active participation of the eligible individual, and working with the individual (or the individual's authorized health care decision maker) and others to develop those goals; and
  - identifies a course of action to respond to the assessed needs of the eligible individual;
- ❖ Referral and related activities (such as scheduling appointments for the individual) to help the eligible individual obtain needed services including
- activities that help link the individual with medical, social, educational providers, or other programs and services that are capable of providing needed services to address identified needs and achieve goals specified in the care plan; and
- ❖ Monitoring and follow-up activities:
- activities and contacts that are necessary to ensure the care plan is implemented and adequately addresses the eligible individual's needs, and which may be with the individual, family members, service providers, or other entities or individuals and conducted as frequently as necessary, and including at least one annual monitoring, to determine whether the following conditions are met:
    - services are being furnished in accordance with the individual's care plan;
    - services in the care plan are adequate; and
    - changes in the needs or status of the individual are reflected in the care plan. Monitoring and follow-up activities include making necessary adjustments in the care plan and service arrangements with providers.

TN# 08-020  
Supersedes  
TN# 00-03

Approval Date: 03-10-10

Effective Date 10/01/2009

State Plan under Title XIX of the Social Security Act  
State/Territory: North Carolina  
TARGETED CASE MANAGEMENT SERVICES  
Persons with HIV Disease

Monitoring and follow-up are conducted quarterly and more frequently as necessary to determine whether:

- the individual is receiving medical treatment;
- services are being furnished in accordance with the individual's care plan;
- services in the care plan are needed;
- services in the care plan are adequate; and
- there are changes in the needs or status of the individual, and if so, whether
  - necessary adjustments have been made in the care plan and service arrangements with the providers; or
  - the individual's goals have been met and the individual has been discharged if appropriate.

\_X\_ Case management includes contacts with non-eligible individuals that are directly related to identifying the eligible individual's needs and care, for the purposes of helping the eligible individual access services; identifying needs and supports to assist the eligible individual in obtaining services; providing case managers with useful feedback, and alerting case managers to changes in the eligible individual's needs.

(42 CFR 440.169(e))

Qualifications of providers (42 CFR 441.18(a)(8)(v) and 42 CFR 441.18(b)):

(PROVIDER)

Provider Qualifications

To qualify for certification as a provider of HIV Case Management services, a provider shall meet the following criteria:

- Have a documented record of three (3) years of providing or managing HIV Case management programs. Providers certified prior to 1/1/2010 shall have two years to be in compliance.
- Ensure the provision of HIV case management services by qualified case managers as described in Section 6.3.1 of the HIV Case Management policy. Providers shall have six months from 1/01/2010 to come into compliance with this requirement.
- Ensure supervision of HIV case managers by qualified supervisors as described in Section 6.3.2 of the HIV Case Management policy. Providers shall have six months from 1/01/2010 to come into compliance with this requirement.
- Enroll each physical site with DMA as a provider of HIV case management services in accordance with §1902(a)(23) of the Social Security Act.

TN# 08-020  
Supersedes  
TN# 95-05

Approval Date: 03-10-10

Effective Date 10/01/2009

State Plan under Title XIX of the Social Security Act  
State/Territory: North Carolina  
TARGETED CASE MANAGEMENT SERVICES  
Persons with HIV Disease

- Meet applicable state and federal laws governing the participation of providers in the Medicaid program.
- Maintain certification as a qualified provider HIV case management services and have a collaborative relationship with the physician record.
- Maintain certification as a qualified provider of HIV case management services.
- Demonstrate compliance with initial and ongoing certification processes.
- Demonstrate compliance with the monitoring and evaluation of case management records through a quality improvement plan.
- Allow DMA to review recipient records and inspect agency operation and financial records.
- Notify DMA of proposed changes such as business owner or name change, address or telephone number change, or plans for business dissolution within 30 calendar days of the proposed change and no later than five business days of the actual change.
- Achieve national accreditation with at least one of the designated accrediting agencies within one year of enrollment with Medicaid as a provider. (Providers, who were enrolled prior to 1/1/2010, shall achieve national accreditation within two years of this policy effective date). Designated accrediting agencies include the following: Utilization Review Accreditation Commission (URAC), Community Health Accreditation Program (CHAP) and Commission on Accreditation of Rehabilitation Facilities (CARF).

To qualify for reimbursement for HIV case management services, a provider shall meet all the criteria specified below:

- Be enrolled in accordance with section 1902(a)(23) of the Social Security Act; and
- Meet applicable State and Federal laws governing the participation of providers in the Medicaid program; and
- Meet applicable state and federal laws, including licensure and certification requirements; and
- Be certified by in accordance with standards established by the Division of Medical Assistance (DMA) and certified by DMA as a qualified HIV case management provider.
- Bill only for services that are within the scope of their clinical practice, as defined by HIV Case Management policy.
- Attest by signature that services billed were medically necessary and were actually delivered to the recipient.
- Secure a performance bond pursuant to S.L 2009-0451 Section 10.58(e)

State Plan under Title XIX of the Social Security Act  
State/Territory: North Carolina  
TARGETED CASE MANAGEMENT SERVICES  
Persons with HIV Disease

Provider Certification

In the absence of State licensure laws governing the qualifications and standards of practice for HIV case management providers, the State Division of Medical Assistance will be responsible for the certification process. DMA agrees to implement methods and procedures for certifying providers of HIV case management services as qualified to render services according to professionally recognized standards for quality care. This will ensure that HIV case management services are provided by qualified providers in accordance with section 1902(a)(23) of the Social Security Act. The initial certification is valid for one year.

To be certified and to qualify for reimbursement a provider shall submit a complete and signed application to DMA to include documentation of requirements indicated in the application. The application shall include the following information as identified under *Administrative, Case Management and Human Resource Requirements*:

*Administrative Requirements*

- A list of counties to be served;
- Hours of operation, the agency shall maintain regularly scheduled hours of operation;
- Emergency after hours response plan;
- A list of potential community resources for the entire service area;
- A copy of Articles of Incorporation, unless the agency is a local government unit;

The agency shall meet the following requirements:

- Have a physical business site at the time of application. The business site shall be verified by a site visit. This site cannot be in a private residence or vehicle.
- Submit a copy of the agency's organizational chart
- Submit a list of person who have five percent or more ownership in all or any one agency
- Submit a business plan that provides specific information for development costs and projected monthly revenue and expense statement for the 12 months subsequent to the approval of the application and actual revenue and expense statement for the 12 months preceding the application date. This plan must:
  - Include assumed consumer base, services, revenues and expenses;
  - Outline management of initial expenses;
  - Identify the individuals responsible for the operation of the agency and shall include their respective resumes;
  - Show a program development enhancement timetable; and include existing financial resources

State Plan under Title XIX of the Social Security Act  
State/Territory: North Carolina  
TARGETED CASE MANAGEMENT SERVICES  
Persons with HIV Disease

- Have computer capability to meet the following criteria:
  - Comply with Information Technology standards required by DMA, inclusive of maintenance of electronic records
  - Meet HIPAA requirements for safety and security of all data
  - Perform data analysis, inclusive of tracking and trending of outcome metrics
  - Comply with electronic billing requirements
  - Comply with requirements for Electronic Funds Transfer (EFT)
  - Communicate with Community Care of North Carolina (CCNC) or the primary care provider on a monthly basis as defined in Subsection 5.3 of the HIV Case Management policy.
- Comply with the completion of a precertification onsite visit in accordance with the Pre certification Site Visit checklist in the Records and Documentation Manual.
- Meet all applicable state and federal licensure and certification requirements to include the following written policies that are unique to the organization:
  - Confidentiality policy, to include a copy of the informed consent form;
  - Recipient grievance policy;
  - Recipient rights policy;
  - Non-discrimination policy;
  - Code of ethics policy;
  - Conflict of interest policy;
  - Electronic records policy;
  - Medical records policy to include record retention, safeguard of records against loss, tampering, defacement or use of and secure transportation of records;
  - Policy to assure the recipient's freedom of choice among providers;
  - Transfer and discharge policy and ;
  - Identification of abuse, neglect, and exploitation policy.

Case Management Requirements

- A description of the core components described in Section 5.0 of the HIV Case Management policy, including the title and position of the individuals who will perform those functions. Applicable FTEs or functions must be documented to meet requirements;
- A quality improvement plan pursuant to Subsection 6.2.1 (2) in the HIV Case Management policy, including but not limited to plans for:
  - Measuring recipient health outcomes;
  - The monitoring and evaluation of case management records (refer to Subsection 7.5 of the HIV Case Management policy);
  - Tracking and reporting complaints and how they are resolved;

State Plan under Title XIX of the Social Security Act  
State/Territory: North Carolina  
TARGETED CASE MANAGEMENT SERVICES  
Persons with HIV Disease

- Conducting statistical studies including cost and utilization studies ;
- Assuring accuracy with claims and service records; and
- Assuring that the provider and staff meet the qualifications set forth in the HIV Case Management policy.

Human Resource Requirements:

- Human resource policies unique to the organization to include process for validation of credentials, continuing education requirements, and criminal background check on all employees;
- Plan for providing case management if the agency has insufficient case management staff to cover caseload. plan for delegation of management authority for the operation of the agency and services;
- Plan for utilizing the services of volunteers, including supervision requirements for maintaining recipient confidentiality
- The agency shall submit the following
  - Supervision and training plan;
  - Case manager orientation plan and an annual in service education plan for the case managers;
  - Agency's plan for networking with CCNC or the primary care provider;
  - Agency's plan for tracking the case manager's demonstrated skill, abilities, competencies and knowledge
- The agency shall meet the following requirements
  - Be owned and operated by individual(s) that have not been convicted of a felony charge related to fraud, theft, embezzlement, breach of fiduciary responsibility or other financial misconduct.
  - Be owned and operated by individual(s) that have not been convicted of a felony charge related to the neglect or abuse of a recipient in connection with the delivery of health care services.
  - Employ qualified and trained case managers and supervisors, or contract with an agency or individual to provide case management or supervision who meets the qualifications as described in Subsections 6.3 and 6.4.

Note: If any elements of this section are non-compliant, the application is considered incomplete and handled pursuant to Section 6.2.1 of the HIV Case Management policy.

Quality Assurance Monitoring

A newly certified agency will be provided with four quality assurance (QA) site visits, to be completed within the first year following certification. The QA site visits are initiated by DMA after the agency is certified.

TN# 08-020  
Supersedes  
TN# NEW

Approval Date: 03-10-10

Effective Date 10/01/2009

State Plan under Title XIX of the Social Security Act  
State/Territory: North Carolina  
TARGETED CASE MANAGEMENT SERVICES  
Persons with HIV Disease

The purpose of the site visits include technical assistance and consultation, review of staff qualifications and training, review of case management services, investigation of complaints and ensure implementation of policy requirements which include quality improvement activities.

If deficiencies are identified, the provider shall submit a written plan of correction within 30 calendar days, upon written request from DMA. Upon review of the plan of action, QA visits will be scheduled as necessary to determine if corrective action has taken place and if the service is compliant with all of the program's requirements.

Failure to adhere to policy requirements will result in decertification or a provisional recertification or a referral to DMA's Program Integrity unit.

Recertification

The recertification is valid for two years, unless otherwise specified. To be recertified a provider shall:

- Submit a complete signed renewal application to DMA no later than 60 calendar days prior to certification expiration date.
- Submit copies of all items in Subsection 6.2.1 of the HIV Case Management Policy that have changed since the initial certification.
- Submit copies of all HIV CM and supervisor credentials.
- Submit an annual summary of quality improvement activities to include outcome metrics.
- Submit documentation that verifies the provider's National Accreditation is current and in good standing.
- Submit to recertification on site visits, including a review of recipient records or other clinical and business documentation, as needed.

DMA shall provide a provisional recertification for a period of six months if site visits show evidence of noncompliance with policy requirements.

Decertification Process

If any one of the following conditions is substantiated, the provider may be decertified by DMA and disenrolled by DMA. This list is not all inclusive.

- Failure to provide core service components;
- Fraudulent billing practices;
- Owner(s) being convicted of a felony charge;
- Failure to develop, submit, and implement a written plan of correction to resolve unmet program requirements cited by DMA ; to make recommended corrections; or both within 30 calendar days;

TN# 08-020  
Supersedes  
TN# NEW

Approval Date: 03-10-10

Effective Date 10/01/2009

State Plan under Title XIX of the Social Security Act  
State/Territory: North Carolina  
TARGETED CASE MANAGEMENT SERVICES  
Persons with HIV Disease

- Falsification of records;
- Violation of a recipient's confidentiality;
- Employment of staff who do not meet the criteria stated in Subsection 6.3;
- Failure of staff to attend the DMA mandatory basic training within 90 days of their employment date;
- Failure of staff to obtain required continuing educational units (CEU), as specified in Subsection 6.4;
- Failure to provide case management staff with supervision to meet the recipients' needs;
- Failure to submit any required documentation within the time frame designated by the HIV Case Management policy or upon request from DMA;
- Failure to provide documentation as specified in Subsection 7.4.2 that is sufficient to support the agency's billing;
- Failure to implement and enforce a quality improvement program;
- Failure to notify DMA, within 30 calendar days of proposed changes or five business days of actual changes, of any changes in agency name, director/ownership, mailing address, and telephone number(s), resulting in the DMA's inability to contact the agency;
- Failure to comply with all applicable federal and state laws, regulations, state reimbursement plan, and policies governing the services authorized under the Medicaid program;
- Failure of an agency to enroll any recipients within four months of certification;
- Failure of an agency to achieve and or maintain the requirements for certification as defined in Section 6.0 of the HIV Case Management policy.

When a provider agency is decertified by DMA, due process/appeal rights shall be issued to the provider agency, in accordance with NCGS 150B-23(a) and 130A-24.

(STAFF)

Staff Qualifications

It is the responsibility of the provider agency to verify staff qualifications and credentials prior to hiring and assure during the course of employment that the staff member continues to meet the requirements set forth in the HIV Case Management policy. Verification of staff credentials shall be maintained by the provider agency.

*HIV Case Manager*

An HIV case manager shall meet *one* of the following *qualifications*:

- Hold a master's degree from an accredited college or university in a human services field, including, but not limited to, social work, sociology, child development, maternal and child health, counseling, psychology, or nursing.

TN# 08-020  
Supersedes  
TN# NEW

Approval Date: 03-10-10

Effective Date 10/01/2009



State Plan under Title XIX of the Social Security Act  
State/Territory: North Carolina  
TARGETED CASE MANAGEMENT SERVICES  
Persons with HIV Disease

- Hold a bachelor's degree from an accredited school of social work.
- Hold a bachelor's degree from an accredited college or university in a human services field or related curriculum, including at least 15 semester hours in courses related to social work, counseling, or public health; and have six months of social work or counseling experience.
- Hold a bachelor's degree from an accredited college or university and have one year of experience in counseling or in a related human services field that provides experience in techniques of counseling, casework, group work, social work, public health, or human services.
- Be licensed, if applicable, by the appropriate licensure board in North Carolina as a registered nurse, nurse practitioner, physician, physician assistant, or certified substance abuse counselor and have two years of experience working in human services.
  - In addition, the case manager must possess two years case management experience. Twelve months of those two years must include experience with HIV+ persons. All case managers must possess or acquire through cross training a clinical understanding of HIV, as evidenced by documentation in their personnel file.
  - Case management experience encompasses the functions of intake, assessment, reassessment, service planning, case coordination, case conferencing, service plan implementation, crisis intervention, monitoring, follow-up of services provided and case closure.

An HIV case manager shall meet the following *core competencies*:

- Able to perform the assessment
- Able to provide recipient centered goals for meeting desired outcomes developed in the care plan.
- Able to provide referral and linkage to recipients serviced
- Able to provide monitoring of care and service rendered to recipients
- Able to provide documentation and attestation as to accuracy of the entry by a personal signature

The case manager must possess and demonstrate the following *Knowledge, Skills and Abilities*.

State Plan under Title XIX of the Social Security Act  
State/Territory: North Carolina  
TARGETED CASE MANAGEMENT SERVICES  
Persons with HIV Disease

- Basic knowledge of HIV disease, prevention and treatment techniques. The knowledge should be based on current clinical practice, defined as standards of practice prevalent within one year from the date of hire. The basic knowledge shall include: methods of transmission and treatment, common definitions, general knowledge of medications used to treat HIV and barriers to medication and treatment compliance.
- Communication skills including listening, written, verbal and non-verbal skills
- Ability to gather information and data, and accurately synthesize into written form
- Ability to identify resources, both formal and informal
- Ability to initiate professional/clinical assessments
- Ability to evaluate environmental stressors
- Observation skills inclusive of human behavior, family dynamics, mood changes, etc
- Ability to assess the cultural environment and to interact in a culturally sensitive manner
- Ability to determine if identified services meet the intensity of needs of the recipient and are accomplishing the desired outcomes
- Prioritization skills including time management skills, planning; organizational skills and professional judgment skills
- Ability to review data and draw appropriate conclusions to address the needs of individuals served
- Ability to accurately document case management activities and attesting to its accuracy by personal signature

*HIV Case Manager Supervisor*

An HIV case management supervisor shall meet *one* of the following *qualifications*:

- Hold a master's degree from an accredited college or university in a human services field, including, but not limited to, social work, sociology, child development, maternal and child health, counseling, psychology, or nursing; and one year of human services experience.
- Hold a bachelor's degree from an accredited school of social work and have two years of human services experience.
- Hold a bachelor's degree from an accredited college or university in a human services field or related curriculum, including at least 15 semester hours in courses related to social work or counseling and have two years of experience in human services or public health.
- Hold a bachelor's degree from an accredited college or university and have either three years of human services experience or two years of human services experience plus one year of supervisory experience.

State Plan under Title XIX of the Social Security Act  
State/Territory: North Carolina  
TARGETED CASE MANAGEMENT SERVICES  
Persons with HIV Disease

- Be licensed, if applicable, by the appropriate licensure board in North Carolina as a registered nurse, nurse practitioner, physician, physician assistant, or certified substance abuse counselor; and have either three years of human services experience or two years of human services experience plus one year of supervisory experience.
  - In addition, the HIV case manager supervisor must possess three years case management experience. Twelve months of those three years must include experience with HIV+ persons.
  - Case management experience must encompass the functions of intake, assessment, reassessment, service planning, case coordination, case conferencing, service plan implementation, crisis intervention, monitoring and follow-up of services provided and case closure.

In addition to those listed for the case manager, the case manager supervisor must possess and demonstrate the following *knowledge, skills and abilities*:

- Ability to direct and evaluate the scope and quality of case management services
- Knowledgeable in case management principals, procedures and practices
- Ability to conduct detailed analytical evaluations and studies and prepare related reports and recommendations
- Apply professional level of knowledge of federal and state assistance programs for HIV positive population

The agency shall identify the HIV case manager program supervisor within the organization. The supervisor is to provide “clinical/professional supervision”. This is defined as providing regularly scheduled assistance by a qualified professional to a staff member who is working directly with recipients. The purpose of clinical supervision is to ensure that each recipient receives case management services which are consistent with accepted standards of practice, the needs of the recipient and care plan.

Documentation of supervisory review of case manager’s caseload and proper utilization of case management services is required. The supervisor shall attest to the accuracy of the documentation by a personal signature to include credentials and title. Each recipient record should reflect supervisory review every 4 weeks at a minimum. The frequency of the review should be increased if the findings warrant such action. The review must include the following: The recipient record to assure that all required paperwork as defined by the HIV Case Management policy is in the record. Progress notes should be reviewed for compliance with the requirements in Subsections 7.4.2 and 7.4.3 (c) of the HIV Case Management policy. The billing should be checked for accuracy to assure it corresponds to the progress notes. This is not billable case management time.

TN# 08-020  
Supersedes  
TN# NEW

Approval Date: 03-10-10

Effective Date 10/01/2009

State Plan under Title XIX of the Social Security Act  
State/Territory: North Carolina  
TARGETED CASE MANAGEMENT SERVICES  
Persons with HIV Disease

Contract Staff

Providers may elect to contract with qualified case managers and supervisors. The same qualifications described in Subsections 6.3.1 and 6.3.2 of the HIV Case Management policy is required of both employees and contractors.

Training Requirements

All HIV case managers and case manager supervisors shall complete North Carolina state-sponsored, basic policy training within ninety days of their employment date and must be completed prior to any billed case management units. It is the responsibility of providers to retain copies of certificates of completion issued by DMA.

Upon successful completion of the basic training, the case manager or supervisor will be able to perform all of the following:

- Describe basic HIV information and prevention techniques;
- Describe the scope of work for case managers;
- Identify and explain the core components of HIV case management;
- Demonstrate an understanding of basic ethical issues relating to case management;
- Demonstrate an understanding of the responsibilities and functions of the HIV case manager system of care; and
- Demonstrate an understanding of the documentation requirements of this program as defined in Subsections 7.4.2 and 7.4.3 of the HIV Case Management policy.

Annual Training

All HIV case managers and supervisors are required to attend 20 hours annually of continuing education related to HIV case management. It is the responsibility of providers to retain copies of certificates of completion.

Annual training topics must include, but are not limited, to the following:

- Confidentiality;
- Cultural competency;
- Current trends in HIV disease management;
- Ethics;
- Refresher core components of case management; and
- Medical management/care of individuals who are HIV positive. Ten hours of the 20 hour annual requirement shall include clinically oriented training

State Plan under Title XIX of the Social Security Act  
State/Territory: North Carolina  
TARGETED CASE MANAGEMENT SERVICES  
Persons with HIV Disease

Suggested resources include but are not limited to the following:

- Partners in Information Access for the Public Health Workforce <http://phpartners.org/index.html>
- Regional HIV/AIDS Consortium
- North Carolina AIDS Education Training Center
- North Carolina Area Health Education Centers

Freedom of choice (42 CFR 441.18(a)(1):

The State assures that the provision of case management services will not restrict an individual's free choice of providers in violation of section 1902(a)(23) of the Act.

9. Eligible individuals will have free choice of any qualified Medicaid provider within the specified geographic area identified in this plan.
10. Eligible individuals will have free choice of any qualified Medicaid providers of other medical care under the plan.

Freedom of Choice Exception (§1915(g)(1) and 42 CFR 441.18(b):

\_\_\_\_\_ Target group consists of eligible individuals with developmental disabilities or with chronic mental illness. Providers are limited to qualified Medicaid providers of case management services capable of ensuring that individuals with developmental disabilities or with chronic mental illness receive needed services: [Identify any limitations to be imposed on the providers and specify how these limitations enable providers to ensure that individuals within the target groups receive needed services.]

Access to Services (42 CFR 441.18(a)(2), 42 CFR 441.18(a)(3), 42 CFR 441.18(a)(6):

The State assures the following:

- Case management (including targeted case management) services will not be used to restrict an individual's access to other services under the plan.
- Individuals will not be compelled to receive case management services, condition receipt of case management (or targeted case management) services on the receipt of other Medicaid services, or condition receipt of other Medicaid services on receipt of case management (or targeted case management) services; and
- Providers of case management services do not exercise the agency's authority to authorize or deny the provision of other services under the plan.

Payment (42 CFR 441.18(a)(4):

Payment for case management or targeted case management services under the plan does not duplicate payments made to public agencies or private entities under other program authorities for this same purpose.

State Plan under Title XIX of the Social Security Act  
State/Territory: North Carolina  
TARGETED CASE MANAGEMENT SERVICES  
Persons with HIV Disease

Case Records (42 CFR 441.18(a)(7)):

Providers maintain case records that document for all individuals receiving case management as follows: (i) The name of the individual; (ii) The dates of the case management services; (iii) The name of the provider agency (if relevant) and the person providing the case management service; (iv) The nature, content, units of the case management services received and whether goals specified in the care plan have been achieved; (v) Whether the individual has declined services in the care plan; (vi) The need for, and occurrences of, coordination with other case managers; (vii) A timeline for obtaining needed services; (viii) A timeline for reevaluation of the plan.

Limitations:

Case management does not include, and Federal Financial Participation (FFP) is not available in expenditures for, services defined in §441.169 when the case management activities are an integral and inseparable component of another covered Medicaid service (State Medicaid Manual (SMM) 4302.F).

Case management does not include, and Federal Financial Participation (FFP) is not available in expenditures for, services defined in §441.169 when the case management activities constitute the direct delivery of underlying medical, educational, social, or other services to which an eligible individual has been referred, including for foster care programs, services such as, but not limited to, the following: research gathering and completion of documentation required by the foster care program; assessing adoption placements; recruiting or interviewing potential foster care parents; serving legal papers; home investigations; providing transportation; administering foster care subsidies; making placement arrangements. (42 CFR 441.18(c))

FFP only is available for case management services or targeted case management services if there are no other third parties liable to pay for such services, including as reimbursement under a medical, social, educational, or other program except for case management that is included in an individualized education program or individualized family service plan consistent with §1903(c) of the Act. (§§1902(a)(25) and 1905(c))

The State has limited the amount of HIV Case Management service that may be billed to Medicaid to 16 units per recipient per month. One unit equals 15 minutes, therefore 16 units equals four hours.

Physician Orders

- The case manager shall obtain a physician's written order that details the need for the initiation of HIV case management services.
- Ongoing HIV Case management services beyond two calendar months require a written physician's order attesting to the medical necessity of the additional case management.

TN# 12-008  
Supersedes  
TN# 08-020

Approval Date: 09-06-12

Effective Date 11/01/2012

STATE PLAN UNDER TITLE XIX OF THE SOCIAL SECURITY ACT

State/Territory: North Carolina

CASE MANAGEMENT SERVICES

A. Target Group: All Children to Age 21 Who Are Eligible for EPSDT

B. Areas of State in which services will be provided:

Entire State

Only in the following geographic areas (authority of section 1915(g)(1) of the Act is involved to provide services less than Statewide:

C. Comparability of Services:

Services are provided in accordance with section 1902 (a) (10)(B) of the Act.

Services are not comparable in amount, duration, and scope. Authority of section 1915 (g) of the Act is involved to provide services without regard to the requirements of section 1901 (a) (10) (B) of the Act.

D. Definition of Services:

Case management is a set of interrelated activities under which responsibility for locating, coordinating and monitoring appropriate services for an individual rests with a specific person or organization. The purpose of case management services for children to age 21 is to assist those eligible for Medicaid in gaining access to needed medical, social, educational and other services, to encourage the use of cost-effective medical care by referrals to appropriate providers, and to discourage overutilization of costly services. Case management services will provide necessary coordination with providers of non-medical services such as nutrition programs like WIC or educational agencies, when services provided by these entities are needed to enable the individual to benefit from programs for which she is eligible.

The set of interrelated activities are as follows:

1. Evaluation of the clients' individual situation to determine the extent of or need for initial or continuing case management services.
2. Needs Assessment and reassessment to identify the service needs of the client.
3. Development and implementation of an individualized plan of care to meet the service needs of the client.
4. Providing assistance to the client in locating and referring her to providers and/or programs that can meet the service needs.

State/Territory: North Carolina

5. Coordinating delivery of services when multiple providers or programs are involved in care provision.
6. Monitoring and follow-up to ensure services are received; are adequate to meet the clients' needs; and are consistent with good quality of care.

These activities are structured to be in conformance with 1902 (a)(23) and not to duplicate any other service reimbursed in the Medicaid program.

E. Qualification of Providers:

Enrollment will be accomplished in accordance with Section 1902(a)(23) of the Act.

1. Case Manager Qualifications:

- a. RN licensed in North Carolina with experience in community health nursing or experience in working children and families or
- b. MSW, BSW, or SW meeting State SW, Community Health Assistant qualifications with experience in health and human service or experience in working with children and families or individuals with comparable experience certified by the Department of Environment, Health and Natural Resources as being eligible to provide case management services.

2. Provider Qualifications:

- a. Must have qualified case manager(s)
- b. Must meet applicable state and federal law governing the participation of providers in the Medicaid program.
- c. Must be certified by the Department of Environment, Health and Natural Resources, Maternal and Child Health as a qualified case management provider.

Enrollment is open to all providers who can meet these requirements. In the absence of State licensing laws governing the qualifications and standards of practice for case management services to children, an agreement will be made with the State agency, Department of Environment, Health and Natural Resources, Maternal and Child Health, which has the recognized professional expertise and authority to establish standards that govern case management services for children. As part of the interagency agreement the Department of Environment, Health and Natural Resources, Maternal and Child Health will certify that providers are qualified to render case



State/Territory: North Carolina

management services in accordance with professionally recognized standards for good care. the purpose of this activity is to help assure that case management services are provided by professionally qualified providers in accordance with section 1902(a)(23) of the Act.

3. Certification Process:

The Section through an MOU with the Division of Medical Assistance will implement methods and procedures to certify all providers for case management to children who can demonstrate:

- a. Their capacity to provide case management services.
- b. Their experience with delivery and/or coordination of services for children.
- c. Their capacity to assure quality.
- d. Their experience in sound financial management and record keeping.

Certification is open to all providers who can meet these requirements.

- F. The State assures that the provision of case management services will not restrict an individual's free choice of providers in violation of section 1902(a)(23) of the Act.
1. Eligible recipients will have free choice of the providers of case management services.
  2. Eligible recipients will have free choice of the providers of other medical care under the plan.
- G. Payment for case management services under the plan does not duplicate payments made to public agencies or private entities under other program authorities for this same purpose. Only activities associated with direct services to clients will be considered targeted case management services.

## LEVEL OF CARE CRITERIA

### 4600. General Information

The following criteria are not intended to be the only determinant of the recipient's need for skilled or intermediate care. Professional judgement and a thorough evaluation of the recipient's medical condition and psychosocial needs as well as an understanding of and the ability to differentiate between the need for skilled or intermediate care. Also, the assessment of other health care alternatives should be made as applicable.

### 4601. Skilled Level of Care Criteria

#### 4601.1 Skilled Nursing Care

Skilled nursing services, as ordered by a physician, must be required and provided on a 24-hour basis, 7 days a week.

Skilled nursing care is that level of care which provides continuously available professional skilled nursing care, but does not require the degree of medical consultation and support services which are available in the acute care hospital. Skilled nursing services are those which must be furnished under the direct supervision of licensed nursing personnel and under the general direction of a physician in order to achieve the medically desired results and to assure quality patient care.

Skilled nursing services include observation and assessment of the total needs of a patient on a 24-hour basis, planning and management of a recorded treatment plan according to that which is established and approved by a physician, and rendering direct services to the patient.

#### 4601.2 Factors Frequently Indicating Need for Skilled Care

1. Twenty-four hour observation and assessment of patient needs by a registered nurse or licensed practical nurse.
2. Intensive rehabilitative services as ordered by a physician, and provided by a physical, occupational, respiratory or speech therapist five times per week or as indicated by therapist.
3. Administration and/or control of medication as required by State law to be the exclusive responsibility of registered or licensed nurses and other specific services subject to such limitation.
4. Twenty-four hour performance of direct services that by physician judgement requires:
  - a. a registered nurse
  - b. a licensed practical nurse, or
  - c. other personnel working under the direct supervision of a registered nurse or licensed practical nurse.
5. Medications: Drugs requiring intravenous, hypodermoclysis or nasogastric tube administration. The use of drugs requiring close observation during an initial stabilization period or requiring nursing skills or professional judgement on a continuous basis, frequent injections requiring nursing skills or professional judgement.
6. Colostomy-ileostomy: In the stabilization period following surgery and allowing for instruction in self-care.
7. Gastrostomy: Feeding or other tube feedings requiring supervision and observation by licensed nurses.
8. Oxygen therapy: When monitoring need or careful regulation of flow rate is required.
9. Tracheostomy: When twenty-four hour tracheostomy care may be indicated.
10. Radiation Therapy or Cancer Chemotherapy: When case observation for side effects during course of treatment is required.

10. Isolation: When medically necessary as a limited measure because of contagious or infectious disease.
11. Sterile Dressings: Requiring prescription medications and aseptic technique by qualified staff.
13. Decubitus Ulcer(s): When infected or extensive.
14. Uncontrolled Diabetes
15. Conditions which may require SNF care until maximum rehabilitation potential has been reached (time frames may be adjusted according to rehabilitation progress, complications or other pertinent factors):
  - New CVA – within three months
  - New fractured hip - within three months
  - New amputation – within two months or less, adjusted for fitting with prostheses and necessary teaching
  - Comatose
  - Inoperable brain tumor
  - Terminal CA – last stages
  - New myocardial infarction – within two months or less
  - Congestive heart failure – degree of compensation
  - New cholecystectomy – within one month and healing
  - New mastectomy – within 2-3 weeks
  - New pacemaker – within one month
  - New paraplegic/quadriplegic condition
  - Surgical patients – within one month

#### 4601.3 Less Serious Conditions Which Alone May Not Justify Placement at the Skilled Level

Although any one of these conditions alone may not justify placement at the skilled level, presence of several of these factors may justify skilled care. This determination will require careful judgement.

1. Diagnostic Procedures: Frequent laboratory procedures when intimately related to medication administration (such as monitoring anticoagulants, arterial blood gas analysis, blood sugars in unstable diabetics)
2. Medications: Frequent intramuscular injections, routine or PRN medications requiring daily administration and/or judgement by a licensed nurse.
3. Treatments: Required observation, evaluation and assistance by skilled personnel for proper use or patient's safety (e.g., oxygen, hot packs, hot soaks, whirlpool, diathermy, IPPB, etc.).  
Skilled procedures including the related teaching and adaptive aspects of skilled nursing are part of the active treatment and the presence of licensed nurses at the time when they are performed is required.
4. Dietary: Special therapeutic diets ordered by a physician and requiring close dietary supervision for treatment or control of an illness, such as chronic renal failure, 0.5 grams or less sodium restrictions, etc.
5. Incontinency: Intense bowel and bladder retraining programs if deemed necessary in accordance with facility procedures.
6. Mental and Behavioral Problems: Mental and behavioral problems requiring treatment or observation by skilled professional personnel, to the extent deemed appropriate for the nursing home.
7. Psychosocial Conditions: The psychosocial conditions of each patient will be evaluated in relation to his/her medical condition when determining a change in level of care. Factors taken into consideration along with the patient's medical needs include age, length of stay in current placement, location and condition of spouse, proximity of social support and the effect of transfer on the patient. It is understood that there can always be, to a greater or lesser degree, some trauma with transfer; even sometimes from one room or hall to

another within the same facility. Whenever a patient/resident exhibits acute psychological symptoms, these symptoms and the need for appropriate services and supervision must have been documented by physician's orders or progress notes, and/or by nursing or therapy notes. Proper and timely discharge planning will help alleviate the fear and worry of transfer.

#### 4602. Intermediate Level of Care Criteria

Intermediate care, as ordered by a physician, must be provided on a 24-hour basis, with a minimum of eight hours of licensed nurse coverage daily. Intermediate care is that level of care which provides daily licensed nursing care, but does not require the 24-hour skilled nursing services required in a skilled nursing facility. ICF services must be furnished under the direction of a physician in order to promote and maintain the highest level of functioning of the patient, and to assure quality patient care.

Intermediate care includes daily observation and assessment of the total needs of the patient by a licensed nurse, planning and management of a recorded treatment plan according to that which is established and approved by a physician, and rendering direct services to the patient. In summary, the philosophy of intermediate care is to maintain patients at their maximum level of self care and independence, prevent regression, and/or return them to a previous level of or new stage of independence.

##### 4602.1 Factors Frequently Indicating Need For Intermediate Care (ICF)

1. Need for daily licensed nurse observation and assessment of patient needs.
2. Need for restorative nursing measures to maintain or restore maximum function, or to prevent the advancement of progressive disabilities as much as possible. Such measures may include, but are not limited to the following:
  - a. encouraging patients to achieve independence in activities of daily living by teaching self care, transfer and ambulation activities.
  - b. use of preventive measures/devices to prevent or retard the development of contractures, such as positioning and alignment, range of motion, use of handrolls and positioning pillows.
  - c. ambulation and gait training with or without assistive devices.
  - d. assistance with or supervision of transfers.
3. Need for administration and/or control of medications which, according to State law, are to be the exclusive responsibility of licensed nurses and any other specific services which are subject to such limitations.
4. Performance of services that by physician judgement require either:
  - a. a licensed nurse a minimum of 8 hours daily; or
  - b. other personnel working under the supervision of a licensed nurse.
5. Medications: The use of drugs for routine and/or maintenance therapy requiring daily observation for drug effectiveness and side effects.
6. Assistance with activities of daily living (i.e., bathing, eating, toileting, dressing, transfer/ambulation), including maintenance of foley catheters and ostomies, supervision of special diets, and proper skin care of incontinent patients.
7. Colostomy – Ileostomy: Maintenance of ostomy patients, including daily monitoring and nursing intervention to assure adequate elimination and proper skin care.
8. Oxygen Therapy: Oxygen as a temporary or intermittent therapy.
9. Radiation Therapy or Cancer Chemotherapy: When a physician determines that daily observation by a licensed nurse is required and adequate.

10. Isolation: When medically necessary on a limited basis because of non-complicated contagious or infectious disease requiring daily observation by licensed personnel, not complicated by other factors requiring skilled care.
11. Dressings: Requiring prescription medications and/or aseptic or sterile technique no more than once daily by licensed staff.
12. Skin Condition:
  - a. decubitus ulcer(c) when not infected or extensive
  - b. minor skin tears, abrasions or chronic skin condition requiring daily observation and/or intervention by licensed personnel.
13. Diabetes: When daily observation of dietary intake and/or medication administration is required for proper physiological control.

4602.2 Illustrative Requirements Which, When Present in Combination, Can Justify Intermediate Level Placement

1. Tracheostomy: When minimal assistance or observation of self care technique is required.
2. Need for teaching and counseling related to a disease process and/or disabilities, diet or medications.
3. Ancillary Therapies: Supervision of patient performance of procedures taught by physical, occupational or speech therapists. This may include care of braces or prostheses and general care of plaster casts.
4. Injections: Given during the hours a nurse is on duty requiring administration and/or professional judgement by a licensed nurse.
5. Treatments: Temporary cast, braces, splint, hot or cold applications, or other appliances requiring nursing care and direction.
6. Psychosocial Considerations: The psychosocial condition of each patient will be evaluated in relation to his/her medical condition when determining a change in level of care. Factors taken into consideration along with the patient's medical needs include age, length of stay in current placement, location and condition of spouse, proximity of social support and the effect of transfer on the patient. It is understood that there can always be, to a greater or lesser degree, some trauma with transfer, even sometimes from one room or hall to another within the same facility. Whenever a patient/resident exhibits acute psychological symptoms, these symptoms and the need for appropriate services and supervision must have been documented by physician's orders or progress notes, and/or by nursing or therapy notes. Proper and timely discharge planning will help alleviate the fear and worry of transfer.
7. Use of protective devices or restraints to assure that each patient is restrained in accordance with the physician's order and that the restrained patient is appropriately evaluated and released at a minimum of every two hours.
8. Other conditions which may require ICF care:
  - Blindness
  - Behavioral problems such as wandering, verbal disruptiveness, combativeness, verbal or physical abusiveness, inappropriate behavior when these can be properly managed in an intermediate care facility.
  - Frequent falls.
  - Chronic recurrent medical problems which require daily observation by licensed personnel for prevention and/or treatment.

Inpatient psychiatric facility services for individuals under 21 years of age.

DEFINITION:

Inpatient psychiatric services for recipients under age 21 must be provided by a psychiatric facility or an inpatient program in a psychiatric facility that meets the following requirements:

- (a) For private owned facilities:
  - (1) A psychiatric hospital or an inpatient psychiatric program in a hospital, accredited by the Joint Commission on Accreditation of Healthcare Organizations, or
  - (2) A psychiatric residential treatment facility which is accredited by the Joint Commission on Accreditation of Healthcare Organizations, or the Council on Accreditation of Services for Families and Children, or the Commission on Accreditation of Rehabilitation Facilities.
- (b) For state owned facilities:
  - (1) A psychiatric residential treatment facility accredited by any other accrediting organization with comparable standards that is recognized by the State DHHS.
  - (2) A psychiatric hospital accredited by the Joint Commission on Accreditation of Healthcare Organizations.

These services are provided before the recipient reaches age 21 or, if the recipient was receiving the services immediately before he or she reached age 21, before the earlier of the following:

- (a) The date he or she no longer requires the services; or
- (b) The date he or she reaches age 22.

CRITERIA FOR MEDICAID COVERAGE OF SERVICES IN A NON ACUTE INTENSIVE  
REHABILITATION PROGRAM FOR HEAD INJURY CARE

---

13. D. Diagnostic, Screening, Treatment, Preventive and Rehabilitative Services  
Description of Services

Non-acute intensive rehabilitation services for head injury care

The state provides head injury care in the most appropriate setting based on medical necessity. This service is for persons who meet medical necessity for skilled nursing care. It is provided in a 24 hour separate setting in a licensed nursing facility for brain injury caused by external trauma.

Description of Service

This service provides intensive rehabilitative services for head injured persons. Services must be under the direction of a qualified physician and include nursing services, as well as a minimum of 15 hours per week of at least two types of the following therapies: Physical Therapy, Occupational Therapy, Cognitive Therapy and Speech Therapy. Recreational therapy must be available that provides activities, selected by the recipient, as a means to furthering individualized rehabilitation goals. Services are designed to effect a measurable and timely improvement in functional status. Recipients must be approved for this level of care by the Division of Medicaid or designated agency and must have specific functional goals and the potential to benefit from rehabilitative services. Continued stay reviews occur every 30 days.

Services include 24 hour care and medical supervision in addition to rehabilitative services that address the specific functional deficits of the individual, such as loss of speech, mobility, cognitive abilities and the abilities to carry out activities of daily living.

Provider Qualifications

Professional staff must meet all state licensure and certification requirements for their area of practice including licensed physicians, nurses, physical therapists, occupational therapists, psychologists and speech therapists. Direct care staff, social workers, dietary, and ancillary staff must meet requirements commensurate with those for skilled nursing facilities.

There is a need for a separate rate to be established commensurate with the level of rehabilitative care required to treat this type of patients. Other non-rehabilitative brain injury care is available in existing NF's.

INTENTIONALLY LEFT BLANK

TN No: 07-003  
Supersedes  
TN No: 91-41

Approval Date: 11/24/08

Eff. Date 01/01/07



## Geropsychiatric Care Units in Nursing Facilities

### I. Definition

Geropsychiatric care is a separate or distinct part setting for nursing facility level of care individuals with long-term psychiatric and behavioral health needs and who exhibit challenging and difficult behaviors that are beyond the management capacity of traditional skilled nursing home facilities in community-based facilities.

### II. Services Definition

Geropsychiatric units must provide a therapeutic environment using the least restrictive alternatives that promote the maintenance and enhancement of the recipient's quality of life. (10A NCAC 27E .0101) These therapeutic elements are provided through:

- a. Enhanced nursing services to meet both the nursing care and behavioral care needs of the recipients
- b. Psychiatric services to address the recipients' needs related to the management of symptoms and medications for severe and persistent mental illness (i.e. Psychiatrist will be part of the on-going treatment assessment and treatment planning of the patient)
- c. Psychological services to develop and implement behavior management plans, including training nursing staff in ongoing implementation of the plan (i.e. Psychologist will be part of the on-going treatment assessment and treatment planning of the patient)
- d. Social work services to coordinate the enhanced behavioral health care services provided to the recipients
- e. Licensed psychiatric nursing services to supervise and coordinate the nursing and medical services being provided to the recipients
- f. Programming that is focused on maintaining previously learned psychosocial and recreational skills

### III. Eligibility Criteria for recipients

- A. The recipient must meet nursing facility level of care criteria.
- B. The recipient must meet the definition of severely persistent mental illness or severe behavioral issues as defined by the following:
  1. A major mental disorder diagnosable under the Diagnostic and Statistical Manual of Mental Disorders, including, but not limited to, schizophrenia, bipolar disorder major depression, schizoaffective disorder, schizophreniform disorders, and psychotic disorder NOS (Not Otherwise Specified).
  2. Upon admission, the recipient's Global Assessment of Functioning score is 40 or lower.

Geropsychiatric Care Units in Nursing Facilities - Continued

- C. The level of the recipient's impairment is confirmed by a level II Pre-admission Screening and Annual Resident Review evaluation.
- D. The recipient is currently in a psychiatric hospital; or has had one or more past hospitalizations; or is exhibiting behaviors that place him or her at risk of psychiatric hospitalization in a State, public, or private psychiatric hospital in the State of North Carolina.
- E. The recipient exhibits chronic, unsafe behaviors that cannot be managed in a traditional nursing facility, including one of the following:
  - 1. Elopement or wandering,
  - 2. Combative and assaulting behaviors (physical or verbal abuse toward staff, or self-abuse),
  - 3. Sexually aggressive behaviors (touching or grabbing others, for example)
  - 4. Self-endangering behaviors, including suicidal ideation and medicine noncompliance, or
  - 5. Other challenging and difficult behaviors related to the individual's psychiatric illness.
- F. Alternative services to meet the person's behavioral health needs are not available.
- G. Prior approval is required.

IV. Provider Qualifications

Nursing facilities that meet Medicaid's qualifications for participation and are currently enrolled with the N.C. Medicaid program are eligible to establish geropsychiatric units and receive the special rate when they meet the additional staffing and certification requirements for geropsychiatric units and execute an agreement with DMA to provide the service.

V. Establishing Unit

The enhanced skilled nursing units must be an on-site geropsychiatric component of a licensed nursing facility and must be certified (42 CFR 483) to receive Medicaid and Medicare reimbursements.

The facility must meet nursing facility requirements as well as an enhanced level of nursing care to meet the special nursing and behavioral health needs of the residents. The facility must be certified and monitored by the Division of Health Service Regulation for compliance with nursing facility rules. This compliance is to ensure that the facility is designed, constructed, equipped, and maintained to protect the health and safety of residents, personnel, and the public.

The facility must also provide a therapeutic environment with enhanced and trained staff as identified below in (Staff Training Requirements).

TN No. 08-007

Supersedes

TN No. NEW

Approval Date 01/15/09

Effective Date: 07/01/08

### Geropsychiatric Care Units in Nursing Facilities Continued

(MH/DD/SAS) monitors all specialty training for the enhanced nursing staff in a therapeutic environment to ensure that it is timely maintained and documented. If training requirements are not met, the nursing facility does not qualify for the nursing specialty services, geropsychiatry. MH/DD/SAS Program Accountability will monitor all geropsychiatric units for the following through its annual program assessments/reviews:

- Therapeutic environment
- Staffing
- Staff training

All nursing facilities must provide a separate or distinct part and sufficient space on the geropsychiatric unit. They must also provide equipment in dining, medical health services, recreation, and program areas to enable staff to provide residents with needed behavioral health services.

A provider agreement between DMA and the facility is required.

There are two options for establishing a geropsychiatric unit in a nursing facility:

- A. A nursing facility may use no more than 20 currently certified nursing beds to create the geropsychiatric services unit. There must be clinical documentation to ensure that existing residents meet criteria for the geropsychiatric unit and that the geropsychiatric unit is the most appropriate placement for residents who would otherwise be displaced. The nursing facility must also provide a transition plan for any residents who will be displaced by the creation of the geropsychiatric unit.
- B. A nursing facility may expand its current number of certified beds by converting existing beds that are not currently certified beds or by developing new certified nursing beds. If this option is selected, the Certificate of Need (CON) requirements apply and the facility must meet and follow all CON requirements. The CON must be approved prior to the final approval of a proposal to develop a geropsychiatric unit in the nursing facility.

#### VI. Staff Training Requirements

All nursing staff (RNs, LPNs, and CNAs) must complete no fewer than 40 initial hours of staff training (20 hours annually thereafter) on behavioral health management issues for challenging and difficult behaviors, and additional training as professionally required (10A NCAC 27E .0107). The staff training calendar and schedule are planned by the Staff Development Coordinator with approval of MH/DD/SAS. All nurses and CNAs are required to participate in this training. The facility orientation will include additional training for all nursing facility staff assigned to the geropsychiatric unit.

### Geropsychiatric Care Units in Nursing Facilities Continued

The additional training curriculum is defined by the MH/DD/SAS training guidelines. Training consists of at least 40 hours. Training includes, but is not limited to, the mental health, nursing, and medical guidelines for treating the geropsychiatric patient population to ensure employee skilled competencies in the following areas:

- A. Person-centered thinking and Person-centered care planning
- B. Assessment of mental status
- C. Documentation of behaviors
- D. Loss and grief
- E. Establishment of a therapeutic environment
- F. Effective communication with families
- G. Effective communication with persons with cognitive deficits
- H. Physical, social, and emotional self-awareness
- I. Recognition of symptoms of mental illness
- J. Sexuality and aging
- K. Mental illness and the aging population
- L. Crisis prevention and intervention
- M. Relocation trauma; psychological aspects of change
- N. Stress management and impact on caregivers
- O. Psychotropic medications and side effects and adverse reactions in the elderly
- P. Reality orientation
- Q. Problem solving: bathing
- R. Problem solving: incontinence
- S. Therapeutic approaches and interventions for problem behaviors
- T. Elopement precautions
- U. Working with aggressive, assaulting, and sexual behaviors
- V. Training for staff self-protection

TN No. 08-007  
Supersedes  
TN No. NEW

Approval Date 01/15/09

Effective Date: 07/01/08

Geropsychiatric Care Units in Nursing Facilities Continued

VII. Continued Stay Criteria

Continued stay in a geropsychiatric unit is applicable when the geropsychiatric resident either:

1. exhibits unsafe behaviors in the specialty nursing unit (as outlined in paragraph III.E. Eligibility Criteria for recipients); or
2. exhibits the unsafe behaviors if moved from the enhanced services available in the geropsychiatric unit, as evidenced by exploratory visits in the regular nursing facility unit, during which unsafe behaviors are observed.

VIII. Discharge Criteria

A. Discharge from a geropsychiatric unit is contingent upon:

1. the consistent absence of unsafe behaviors (as outlined in paragraph III.E. Eligibility Criteria for recipients) in a consistently structured geropsychiatric specialty nursing unit; and
2. the anticipation that the individual will not exhibit unsafe behaviors if transitioned from the geropsychiatric unit, as evidenced by exploratory visits to a regular nursing unit, during which unsafe behaviors are not observed.

These criteria must be closely observed and monitored during a continuous period of at least three months.

B. Additional determining criteria for discharge include the following:

1. Monitoring of medication stability/consistency;
2. Treatment compliance;
3. Appropriate living arrangements upon discharge; or
4. Arrangement of aftercare for continued services in the community, with family/guardian support and involvement.

CRITERIA FOR VENTILATOR-DEPENDENT RECIPIENTS  
(Hospital Based or Nursing Facility)

I. Definition

- A. Ventilator dependent is defined by the Division of Medical Assistance as requiring at least ten (10) hours/day of mechanical ventilation to maintain a stable respiratory status.

II. Criteria

- A. Recipient's condition must meet the definition of ventilator dependence.
- B. The recipient's condition at time of placement must be stable without infections or extreme changes in ventilatory settings and/or duration (i.e. increase in respiratory rate by 5 breaths per minute, increase in FIO<sub>2</sub> of 25% or more, and/or increase in tidal volume of 200 mls or more).
- C. The recipient must have prior approval for admission to a long term care facility. Prior approval requests for ventilator services must include the following:
- a. The FL-2 or the North Carolina Medicaid designated screening form with the PASARR number, signed and dated by the attending physician.
  - b. Medical records documenting the criteria for ventilator level of care.
  - c. A ventilator addendum form, signed and dated by the attending physician within 45 days of the authorization for ventilator level of care.

Medical Care/Other Remedial Care

Services provided under this section are provided by individual practitioners who meet individual practitioner certification standards. Each provider must be certified as meeting program standards of the Department of Health and Human Services. The services are available to the categorically needy and medically needy and include the services described herein.

- A. Generally covered state plan services provided to outpatients by qualified health professional service entities to include prevention, diagnostic, therapeutic or palliative items or services when they are medically necessary.
- 1) Diagnostic services includes medical procedures or supplies recommended by a physician or other licensed practitioner of the healing arts within the scope of his practice that enable him to identify the existence, nature or extent of illness, injury or other health deviation.
  - 2) Screening services includes standardized tests performed under medical direction by qualified health care professionals to a designated population to detect the existence of one or more particular diseases.
  - 3) Preventive services includes services provided by a physician or other licensed practitioner of the healing arts within the scope of practice under state law to a) prevent disease, disability and other health conditions or their progression b) prolong life and c) promote physical and mental health and efficiency.
  - 4) Therapeutic services means medical care and clinical services for a patient for the purpose of combating disease, injury or other physical/mental disorders by a physician or other qualified practitioner within the scope of practice under state law.
  - 5) Physical therapy occupational therapy and services for individuals with speech, hearing, and language disorders as defined in 42 CFR 440.110. Services are limited to EPSDT eligibles.

- 6) Psychosocial services include assessment, testing, clinical observation and treatment when provided by a psychologist licensed in accordance with state law or certified as a school psychologist by the North Carolina Department of Public Instruction or social worker when certified by the North Carolina Department of Health and Human Services. Services provided are limited to EPSDT eligibles.
- 7) Respiratory therapy services as defined in 1902(e)(9)(A) of the Act when provided by a respiratory therapist licensed under the provisions of the North Carolina Respiratory Care Practice Act. Services provided are limited to EPSDT eligibles.

For EPSDT eligibles, services covered under 1905(r)(5) and as required by 1905 (a) to correct, ameliorate defects and physical and mental illnesses and conditions discovered by screening services whether or not such services are included in the state plan.

Service providers will be offering a comprehensive array of health services to eligible individuals throughout the State of North Carolina and will be offering them in the most appropriate settings possible (for example, schools, homes). All services to an individual are provided as directed in an individualized treatment program by a physician or other licensed practitioner of the healing arts within the scope of his/her practice under state law. The treatment plan also directs the duration and scope of services to be provided in order to achieve the goals and objectives of the plan.

Provision of services where the family is involved will be directed to meeting the identified client's treatment needs. Services provided to non-Medicaid eligible family members independent of meeting the identified client's treatment needs are not covered by Medicaid.



CRITERIA FOR MEDICAID COVERAGE OF CERTIFIED REGISTERED NURSE ANESTHETISTS SERVICES

Certified Registered Nurse Anesthetist Services

- 1) are provided in accordance with the scope of practice as defined by the Nursing Practice Act and rules promulgated by the Board of Nursing, and
- 2) are performed by Certified Registered Nurse Anesthetists who are duly licensed as registered nurses by the State Board of Nursing and are credentialled by the Council on Certification of Nurse Anesthetists as Certified Registered Nurse Anesthetists, and recertified through the Council on Recertification of Nurse Anesthetists, and
- 3) are performed in collaboration with a physician, dentist, podiatrist or other lawfully qualified health care provider and, when prescribing a medical treatment regimen or making a medical diagnosis, are performed under the supervision of a licensed physician.

COVERAGE LIMITATIONS

Medical services must be performed in accordance with the Certified Registered Nurse Anesthetists scope of practice.

1. By Certified Registered Nurse Anesthetists in any practice setting.
2. For DMA approved procedures developed for use by Certified Registered Nurse Anesthetists.
3. Subject to the same coverage limitations as those in effect for Physicians.

DEFINITION OF SERVICE

Anesthesiology is the practice of medicine dealing with, but not limited to, the following:

- a. The management of procedures for rendering a patient insensible to pain and emotional stress during surgical, obstetrical, and other diagnostic or therapeutic procedures
- b. The evaluation and management of essential physiologic functions under the stress of anesthetic and surgical manipulations
- c. The clinical management of the patient unconscious from whatever cause
- d. The evaluation and management of acute or chronic pain
- e. The management of problems in cardiac and respiratory resuscitation
- f. The application of specific methods of respiratory therapy
- g. The clinical management of various fluid, electrolyte, and metabolic disturbances

Anesthesia services include the anesthesia care consisting of preanesthesia, intraoperative anesthesia, and postanesthesia components. Anesthesia services include all services associated with the administration and monitoring of the anesthetic/analgesic during various types/methods of anesthesia. Anesthesia services include, but are not limited to, general anesthesia, regional anesthesia, and monitored anesthesia care (MAC). These services entail a preoperative evaluation and the prescription of an anesthetic plan; anesthesia care during the procedure; interpretation of intra-operative laboratory tests; administration of intravenous fluids including blood and/or blood products; routine monitoring (such as electrocardiogram (ECG), temperature, blood pressure, pulse oximetry, capnography, end-tidal infrared gas analysis, mass spectrography, bispectral electroencephalography, and transcranial Doppler); immediate post-anesthesia care, and a postoperative visit when applicable.

Time-based anesthesia services include all care of the patient until the anesthesiologist, resident, anesthesiologist assistant AA<sub>1</sub>, or certified registered nurse anesthetist (CRNA) is no longer in personal attendance.

## QUALIFICATIONS FOR LICENSE

(a) Except as otherwise provided in this Subchapter, an individual shall obtain a license from the Board before practicing as an Anesthesiologist Assistant. The Board may grant an Anesthesiologist Assistant license to an applicant who has met all the following criteria:

(1) submits a completed license application on forms provided by the Board;

(2) pays the license fee established by Rule .0113 in this Subchapter;

(3) submits to the Board proof of completion of a training program for Anesthesiologist Assistants accredited by the Commission on Accreditation of Allied Health Education Programs or its preceding or successor organization;

(4) submits to the Board proof of current certification by the National Commission for Certification of Anesthesiologist Assistants (NCCAA) or its successor organization, including passage of the Certifying Examination for Anesthesiologist Assistants administered by the NCCAA within 12 months after completing training;

(5) certifies that he or she is mentally and physically able to safely practice as an Anesthesiologist Assistant;

(6) has no license, certificate, or registration as an Anesthesiologist Assistant currently under discipline, revocation, suspension, or probation;

(7) has good moral character; and

(8) submits to the Board any other information the Board deems necessary to determine if the applicant meets the requirements of the rules in this Subchapter.

(b) The Board may deny any application for licensure for any enumerated reason contained in G.S. 90-14 or for any violation of the Rules of this Subchapter.

(c) An applicant may be required to appear, in person, for an interview with the Board, or its representatives upon completion of all credentials.

#### COVERAGE LIMITATIONS

Medical services must be performed in accordance with the Anesthesiologist Assistants scope of practice.

4. By Anesthesiologist Assistants in any practice setting.
5. For DMA approved procedures developed for use by Anesthesiologist Assistants.
6. Subject to the same coverage limitations as those in effect for Anesthesiologists, Certified Registered Nurse Anesthetists and Physicians.

TN No. 08-014  
Supersedes  
TN No. NEW

Approval Date: 03/10/09

Eff. Date 10/01/2008

STATE PLAN UNDER TITLE XIX OF THE SOCIAL SECURITY ACT  
Program of All-Inclusive Care for the Elderly (PACE) services

State/Territory: North Carolina

I. Eligibility

The State determines eligibility for PACE enrollees under rules applying to community groups.

- A.  The State determines eligibility for PACE enrollees under rules applying to institutional groups as provided for in section 1902(a)(10)(A)(ii)(VI) of the Act (42 CFR 435.217 in regulations). The State has elected to cover under its State plan the eligibility groups specified under these provisions in the statute and regulations. The applicable groups are:

*(If this option is selected, please identify, by statutory and/or regulatory reference, the institutional eligibility group or groups under which the State determines eligibility for PACE enrollees. Please note that these groups must be covered under the State's Medicaid plan.)*

- B.  The State determines eligibility for PACE enrollees under rules applying to institutional groups, but chooses not to apply post-eligibility treatment of income rules to those individuals. (If this option is selected, skip to II - Compliance and State Monitoring of the PACE Program.

- C.  The State determines eligibility for PACE enrollees under rules applying to institutional groups, and applies post-eligibility treatment of income rules to those individuals as specified below. Note that the post-eligibility treatment of income rules specified below are the same as those that apply to the State's approved HCBS waiver(s).

STATE PLAN UNDER TITLE XIX OF THE SOCIAL SECURITY ACT  
Program of All-Inclusive Care for the Elderly (PACE) services

State/Territory: North Carolina

**Regular Post Eligibility**

1. \_\_\_\_ SSI State. The State is using the post-eligibility rules at 42 CFR 435.726. Payment for PACE services is reduced by the amount remaining after deducting the following amounts from the PACE enrollee's income.
  - (a). Sec. 435.726--States which do not use more restrictive eligibility requirements than SSI.
    - (1.) Allowances for the needs of the:
      - (A.) Individual (check one)
        1. \_\_\_\_ The following standard included under the State plan (check one):
          - (a) \_\_\_\_ SSI
          - (b) \_\_\_\_ Medically Needy
          - (c) \_\_\_\_ The special income level for the institutionalized
          - (d) \_\_\_\_ Percent of the Federal Poverty Level: \_\_\_\_%
          - (e) \_\_\_\_ Other (specify): \_\_\_\_\_
        2. \_\_\_\_ The following dollar amount: \$ \_\_\_\_\_  
Note: If this amount changes, this item will be revised.
        3. \_\_\_\_ The following formula is used to determine the needs allowance:  
  
\_\_\_\_\_  
\_\_\_\_\_

*Note: If the amount protected for PACE enrollees in item 1 is equal to, or greater than the maximum amount of income a PACE enrollee may have and be eligible under PACE, enter N/A in items 2 and 3.*

TN No: 08-013  
Supersedes  
TN No: 06-009

Approval Date: 12/18/08  
Effective Date: 07/01/08

STATE PLAN UNDER TITLE XIX OF THE SOCIAL SECURITY ACT  
Program of All-Inclusive Care for the Elderly (PACE) services

State/Territory: North Carolina

(B.) Spouse only (check one):

1. \_\_\_ SSI Standard
2. \_\_\_ Optional State Supplement Standard
3. \_\_\_ Medically Needy Income Standard
4. \_\_\_ The following dollar amount: \$\_\_\_\_\_
- Note: If this amount changes, this item will be revised.
5. \_\_\_ The following percentage of the following standard  
    that is not greater than the standards above: \_\_\_\_\_% of  
    \_\_\_\_\_ standard.
6. \_\_\_ The amount is determined using the following formula:  
    1924(d)(1)(B) of the Act
7. \_\_\_ Not applicable (N/A)

(C.) Family (check one):

1. \_\_\_ AFDC need standard
2. \_\_\_ Medically needy income standard

*Note: The amount specified below cannot exceed the higher of the need standard for a family of the same size used to determine eligibility under the State's approved AFDC plan or the medically needy income standard established under 435.811 for a family of the same size.*

3. \_\_\_ The following dollar amount: \$\_\_\_\_\_
- Note: If this amount changes, this item will be revised.
4. \_\_\_ The following percentage of the following standard  
    that is not greater than the standards above: \_\_\_\_\_%  
    of \_\_\_\_\_ standard.
5. \_\_\_ The amount is determined using the following formula:  
    1924(d)(1)(C) of the Act
6. \_\_\_ Other
7. \_\_\_ Not applicable (N/A)

(2). Medical and remedial care expenses in 42 CFR 435.726.

STATE PLAN UNDER TITLE XIX OF THE SOCIAL SECURITY ACT  
Program of All-Inclusive Care for the Elderly (PACE) services

State/Territory: North Carolina

Regular Post Eligibility

2. \_\_\_\_\_ 209(b) State, a State that is using more restrictive eligibility requirements than SSI. The State is using the post-eligibility rules at 42 CFR 435.735. Payment for PACE services is reduced by the amount remaining after deducting the following amounts from the PACE enrollee's income.

(A) 42 CFR 435.735--States using more restrictive requirements than SSI.

1. Allowances for the needs of the:

(A.) Individual (check one)

1. \_\_\_\_\_ The following standard included under the State plan (check one):

(a) \_\_\_\_\_ SSI

(b) \_\_\_\_\_ Medically Needy

(c) \_\_\_\_\_ The special income level for the institutionalized

(d) \_\_\_\_\_ Percent of the Federal Poverty Level: \_\_\_\_\_%

(e) \_\_\_\_\_ Other (specify): \_\_\_\_\_

2. \_\_\_\_\_ The following dollar amount: \$ \_\_\_\_\_

Note: If this amount changes, this item will be revised.

3. \_\_\_\_\_ The following formula is used to determine the needs allowance:

\_\_\_\_\_  
\_\_\_\_\_

*Note: If the amount protected for PACE enrollees in item 1 is equal to, or greater than the maximum amount of income a PACE enrollee may have and be eligible under PACE, enter N/A in items 2 and 3.*

(B.) Spouse only (check one):

1. \_\_\_\_\_ The following standard under 42 CFR 435.121:

2. \_\_\_\_\_ The Medically needy income standard

3. \_\_\_\_\_ The following dollar amount: \$ \_\_\_\_\_

Note: If this amount changes, this item will be revised.

4. \_\_\_\_\_ The following percentage of the following standard that is not greater than the standards above: \_\_\_\_\_% of \_\_\_\_\_ standard.

5. \_\_\_\_\_ The amount is determined using the following formula:

\_\_\_\_\_  
\_\_\_\_\_

6. \_\_\_\_\_ Not applicable (N/A)

TN No.: 06-009

Supersedes

TN No.: NEW

Approval Date: 12/04/06

Effective Date: 01/01/07



STATE PLAN UNDER TITLE XIX OF THE SOCIAL SECURITY ACT  
Program of All-Inclusive Care for the Elderly (PACE) services

State/Territory: North Carolina

(C.) Family (check one):

1.  AFDC need standard
2.  Medically needy income standard

*Note: The amount specified below cannot exceed the higher of the need standard for a family of the same size used to determine eligibility under the State's approved AFDC plan or the medically needy income standard established under 435.811 for a family of the same size.*

3.  The following dollar amount: \$ \_\_\_\_\_  
Note: If this amount changes, this item will be revised.
4.  The following percentage of the following standard that is not greater than the standards above: \_\_\_\_\_ % of \_\_\_\_\_ standard.
5.  The amount is determined using the following formula:  
\_\_\_\_\_  
\_\_\_\_\_
6.  Other
7.  Not applicable (N/A)

(b) Medical and remedial care expenses specified in 42 CFR 435.735.

---

TN No.: 06-009  
Supersedes  
TN No.: NEW

Approval Date: 12/04/06  
Effective Date: 01/01/07

STATE PLAN UNDER TITLE XIX OF THE SOCIAL SECURITY ACT  
 Program of All-Inclusive Care for the Elderly (PACE) services

State/Territory: North Carolina

**Spousal Post Eligibility**

3. \_\_\_ State uses the post-eligibility rules of Section 1924 of the Act (spousal impoverishment protection) to determine the individual's contribution toward the cost of PACE services if it determines the individual's eligibility under section 1924 of the Act. There shall be deducted from the individual's monthly income a personal needs allowance (as specified below), and a community spouse's allowance, a family allowance, and an amount for incurred expenses for medical or remedial care, as specified in the State Medicaid plan.

(a.) Allowances for the needs of the:

1. Individual (check one)

(A). \_\_\_ The following standard included under the State plan (check one):

- 1. \_\_\_ SSI
- 2. \_\_\_ Medically Needy
- 3. \_\_\_ The special income level for the institutionalized
- 4. \_\_\_ Percent of the Federal Poverty Level: \_\_\_
- 5. \_\_\_ Other (specify): \_\_\_\_\_

(B). \_\_\_ The following dollar amount: \$ \_\_\_\_\_  
 Note: If this amount changes, this item will be revised.

(C). \_\_\_ The following formula is used to determine the needs allowance:

\_\_\_\_\_  
 \_\_\_\_\_

*If this amount is different than the amount used for the individual's maintenance allowance under 42 CFR 435.726 or 42 CFR 435.735, explain why you believe that this amount is reasonable to meet the individual's maintenance needs in the community:*

These individuals are living in the community and thus have greater needs for shelter, food and clothing. We provide optional coverage for Aged, Blind and Disabled in the community at 100% of the federal poverty level to meet these greater needs.

TN No: 08-013  
 Supersedes  
 TN No: 06-009

Approval Date: 12/18/08  
 Effective Date: 07/01/08

STATE PLAN UNDER TITLE XIX OF THE SOCIAL SECURITY ACT  
Program of All-Inclusive Care for the Elderly (PACE) Services

State/Territory: North Carolina

II. Rates and Payments

A. The State assures CMS that the capitated rates will be equal to or less than the cost to the agency of providing those same fee-for-service State plan approved services on a fee-for-service basis, to an equivalent non-enrolled population group based upon the following methodology. Please attach a description of the negotiated rate setting methodology and how the State will ensure that rates are less than the cost in fee-for-service.

1. X Rates are set at a percent of fee-for-service costs
2. \_\_\_ Experience-based (contractors/State's cost experience or encounter date)(please describe)
3. \_\_\_ Adjusted Community Rate (please describe)
4. \_\_\_ Other (please describe)

B. The State Medicaid Agency assures that the rates were set in a reasonable and predictable manner. Please list the name, organizational affiliation of any actuary used, and attestation/description for the initial capitation rates.

Mercer Government Human Services Consulting  
3131 East Camelback Road  
Suite 300  
Phoenix, Arizona 850164536

Contact: Edward C. Fischer  
602-522-6500

---

TN No.: 06-009  
Supersedes  
TN No.: NEW

Approval Date: 12/04/06  
Effective Date: 01/01/07

STATE PLAN UNDER TITLE XIX OF THE SOCIAL SECURITY ACT  
Program of All-Inclusive Care for the Elderly (PACE) Services

State/Territory: North Carolina

The description of the PACE payment methodology and actuarial certification of these rates is as follows:

1. To develop the UPL's, the state actuary used historical fee-for-service (FFS) data adjusted for the populations and services covered by the PACE program. This includes base information where the recipient is 55 years of age or older, who require a nursing home level of care, and live within a PACE service area. Only the costs of State Plan approved services from this data file were used for the development of UPL's. Separate UPL's were developed for dually eligible individuals (Medicare and Medicaid) and non-dually eligible individuals (Medicaid only) 55 years of age and older. The dual eligible categories QMB only, QDWI, SLMB, QI1, and QI2 are not entitled to Medicaid services and thus are not included in the UPL calculations. Recipients enrolled in managed care programs and services not covered under PACE were excluded.
2. Graduate and Indirect Medical Expenses (GME/IME) and Disproportionate Share Hospital (DSH) payment were not included in the Medicaid Management Information System (MMIS). MMIS data does not reflect rebates collected on pharmacy claims; thus it was appropriate to adjust the pharmacy data to reflect the impact of rebates.
3. Each of the dually eligible and non-dually eligible groups was analyzed separately with costs weighted between institutional and community populations to produce a UPL for each of the two eligibility categories.
4. Adjustments were applied to determine the UPL once the base data was analyzed and determined appropriate. The adjustments include program changes and trend. UPL methodology includes the impact of any programmatic changes.

C. The State will submit all capitated rates to the CMS Regional Office for prior approval.

---

TN No.: 06-009  
Supersedes  
TN No.: NEW

Approval Date: 12/04/06  
Effective Date: 01/01/07

STATE PLAN UNDER TITLE XIX OF THE SOCIAL SECURITY ACT  
Program of All-Inclusive Care for the Elderly (PACE) Services

State/Territory: North Carolina

III. Enrollment and Disenrollment

There is a PACE administrative work group preparing for Pace implementation. The state assures that there will be a process in place to provide for dissemination of enrollment and disenrollment data between state and local agencies and will implement procedures for the enrollment and disenrollment of participants in the state's MMIS, including procedures for any adjustment to account for the difference between the estimated number of participants on which the prospective monthly payment was based and the actual number of participants in that month before the PACE program is approved by the state.

---

TN No.: 06-009  
Supersedes  
TN No.: NEW

Approval Date: 12/04/06  
Effective Date: 01/01/07

**LIMITATIONS ON AMOUNT  
DURATION AND SCOPE OF SERVICES**

General Provisions Applicable to All Services:

Payment for Services Furnished Out-of-State

Out-of-state services, furnished in accordance with 42 CFR 431.52, are subject to the same prior approval and continued stay reviews that would be required if the services were rendered by an in-state provider, and must be subject to the utilization review and oversight requirements of the provider's home state Medicaid program.

In addition, out-of-state services provided in accordance with 42 CFR 431.52(2)(b)(iii) are subject to prior approval to go out of state.

In accordance with 42 CFR 431.52(2)(b)(iv), the state Medicaid agency will determine whether it is the general practice for recipients in a particular locality to use medical providers in another state.

Prior Approval

Prior approval is required for certain procedures, products, and services. The decision to require prior approval for a specific procedure, product or service and the requirements that must be met for prior approval are based on evaluation of the factors such as: utilization; efficacy; safety; potential risk to patients; potential for misuse or abuse; high cost; the availability of more cost effective or equivalent procedures, products and services; and legislative mandate. Specific prior approval requirements are published in Medicaid Clinical Coverage Policies on the NC Division of Medial Assistance website ([www.dhhs.state.nc.us/dma/mp/mpindex.htm](http://www.dhhs.state.nc.us/dma/mp/mpindex.htm)).

Retroactive prior approval for procedures, products, and services that require prior approval will not be permitted, except in cases where retroactive eligibility is established.

1. Inpatient General Hospital Services:

All medical services performed must be medically necessary and may not be experimental in nature. Medical necessity is determined by generally accepted North Carolina community practice standards as verified by independent Medicaid consultants.

- A. Prior approval is required for cosmetic surgery, bone marrow, and surgical transplants excluding bone, skin, corneal, kidney and autologous tendon transplants. Prior approval is based on medical necessity and state medical policy.
- B. Medical necessity for on-going inpatient general hospital services will be determined initially by a hospital's Utilization Review Committee and may be subject to post-payment review by the State Agency. All claims will be subject to prepayment review for Medicaid coverage.
- C. The State Agency may grant a maximum of three Administrative days to arrange for discharge of a patient to a lower level-of-care. With prior approval by the State Medicaid agency, the hospital may be reimbursed for days in excess of the three administrative days at the statewide average rate for the particular level of care needed in the event a lower level-of-care bed in a Medicaid approved health care institution is not available. The hospital must, however, make every effort to place the recipient in an appropriate institution within the three-day administrative time allowance.
- D. The following are non-covered services: telephone, television, or other convenience items not routinely provided to other patients.

PLACE HOLDER FOR  
ATTACHMENT 3.1-A.1  
PAGES 2, 3 AND 4  
ARE OBSOLETE OR HAVE  
BEEN MOVED IN OTHER  
AREAS OF THE STATE  
PLAN, THERE ARE NO  
MISSING PAGES



Mandatory Services 42 CFR 440.230

---

Mandatory services visits are provided in accordance with 42 CFR 440.230 per recipient per State fiscal year. Exceptions to a visit limitation may be authorized by the State when additional visits are medically necessary. The mandatory services visit limit is 22. This limitation does not apply to EPSDT eligible children.

2. a. Outpatient Hospital Services

All medical services performed must be medically necessary and may not be experimental in nature.

- (1) Prior approval shall be required for each psychiatric outpatient visit after the eighth visit for recipients 21 years and over. The visit limitation per year does not apply to recipients 21 years and over receiving mental health services subject to utilization review. Approval will be based on medical necessity.
- (2) Prior approval shall be required for each psychiatric hospital outpatient visit after the 16<sup>th</sup> visit for recipients under age 21.
- (3) Routine physical examinations and immunizations are covered under Adult Health Screening and under Early Periodic Screening Diagnosis and Treatment (EPSDT).
- (4) “Take home drugs”, medical supplies, equipment and appliances are not covered, except for small quantities of medical supplies, legend drugs or insulin needed by the patient until such time as the patient can obtain a continuing supply.
- (5) Injections are not covered if oral drugs are suitable.
- (6) Office visits in a hospital outpatient setting are included in the visit limit per recipient per State fiscal year. This limitation does not apply to adults 21 and over receiving mental health services subject to independent utilization review.

TN No: 10-023  
Supersedes  
TN No: 09-027

Approval Date: 12-23-10

Eff. Date: 11/01/10

Mandatory Services 42 CFR 440.230

---

Mandatory services visits are provided in accordance with 42 CFR 440.230 per recipient per State fiscal year. Exceptions to a visit limitation may be authorized by the State when additional visits are medically necessary. The mandatory services visit limit is 22. This limitation does not apply to EPSDT eligible children.

2. b. Rural Health Clinic Services and other Ambulatory Services Furnished by a Rural Health Clinic

All medical services performed must be medically necessary and may not be experimental in nature.

- (1) Other ambulatory services provided by Rural Health Clinics are:
  - (a) Chiropractic services
  - (b) Dental Services
  - (c) Drugs, legend and insulin
  - (d) EPSDT
  - (e) Eyeglasses and visual aids
  - (f) Family Planning Services
  - (g) Hearing Aids
  - (h) Optometric Services
  - (i) Podiatry Services
- (2) Rural Health Clinic Services are subject to the limitations of the physicians' services program.
- (3) Office visits in a RHC are included in the visit limit per recipient per State fiscal year.

2. c. Federally Qualified Health Center (FQHC) services and other ambulatory services

Limitations are the same as in 2.b

STATE PLAN UNDER TITLE XIX OF THE SOCIAL SECURITY ACT

3. Other laboratory and X-ray services

Laboratory and X-ray services shall be covered to the extent permitted in federal Medicaid regulations and subject to the following conditions:

- (1) The service is not performed in connection with a routine physical examination.
- (2) It is provided in an office or similar facility other than a hospital outpatient department or a clinic.
- (3) Clinical laboratory services are rendered by medical care entities who are issued a certificate of waiver, registration certificate, or certificate of accreditation under the Clinical Laboratories Improvement Amendments of 1988.
- (4) Portable X-ray services are medically necessary and ordered in writing by the attending physician. Services may be provided only by providers who are Medicare certified and inspected by the N.C. Division of Facility Services and are limited to provision in the patient's place of residence. The ordering physician must:
  - (a) State the patient's diagnosis, and
  - (b) Indicate the condition suspected, and
  - (c) Reason why "portable" service is needed.
- (5) Portable ultrasound services are medically necessary and ordered in writing by the attending physician. Providers must be Medicare certified as physiological labs, assure its personnel are licensed or registered in accordance with applicable State laws, and comply with manufacturer's guidelines for use of and routine inspection of equipment. The ordering physician must:
  - (a) State the patient's diagnosis, and
  - (b) Indicate the condition suspected, and
  - (c) Reason why "portable" service is needed

4.a. Nursing Facility Services

- (1) Prior approval is required. This approval is based on reporting form for each patient to be admitted to a nursing facility signed by the attending physician which indicates anticipated restoration potential, treatments orders, and type of care recommended.

- (2) Where cases warrant expeditious action, telephone approvals can be obtained; these must be followed up with the completed reporting form indicated in (1) above.
- (3) Private accommodations are authorized only when directed by a physician as medically necessary or when all semi-private accommodations are occupied.
- (4) The items and services furnished in NFs and ICF-MRs that are payable by the Medicaid Program when medically necessary and for which recipients may not be charged are listed below. Unless stated otherwise these services are payable only to long term care facilities.
  - (a) Semi-private room, ward accommodations or private room if medically necessary, including room supplies such as water pitchers, basins, and bedpans.
  - (b) Nursing staff services.
  - (c) Food and intravenous fluids or solutions.
  - (d) Linens and patient gowns and laundering of these items.
  - (e) Housekeeping services.
  - (f) Social services and activity programs.
  - (g) Physical therapy, speech therapy, audiology, occupational therapy, respiratory therapy, and all other forms of therapy.
  - (h) Medical supplies, oxygen, orthotics, prostheses and durable medical equipment.
  - (i) Non legend drugs, serums, vaccines, antigens, and antitoxins.
  - (j) Transportation to other medical providers for routine, non-emergency care.
  - (k) Laboratory and radiology services, payable to either the long term care facility or directly to the provider furnishing the service.
  - (l) Physician and dental services, payable only to the practitioners if provided in private facilities.
  - (m) Legend drugs and insulin payable only to pharmacies if provided in private facilities.
  - (n) Transportation to other medical providers for emergency care, payable only to ambulance providers.

The following items can be charged to recipients:

- (a) Customary room charge to reserve a room during a recipient's hospital stay, therapeutic leave in excess of the maximum allowed, and other absences.
- (b) Customary private room differential charge if a private room is not medically necessary.
- (c) Private duty nurse or attendants.
- (d) Telephone, television, newspaper, and magazines.
- (e) Guest meals.
- (f) Barber and beauty shop, services other than routine grooming required as part of the patient's care plan.
- (g) Personal clothing and laundry
- (h) Personal dental and grooming items.
- (i) Tobacco products
- (j) Burial services and items.

Level of Care criteria is described in Appendix 1 of Attachment 3.1-A. Level of Care criteria for non acute intensive rehabilitation head-injury care described in Appendix 3 of Attachment 3.1-A. Level of Care criteria for ventilator-dependent care described in Appendix 4 of Attachment 3.1-A.

4.b. Early and Periodic Screening, Diagnosis and Treatment

(1) Hearing Aid Services

Prior approval is required for hearing aids. The prior approval request must be supported by a certification of need for beginning the hearing aid selection process (medical clearance) from a physician or otologist (including otolaryngologist or otorhinolaryngologist). A copy of the hearing evaluation (including the audiogram) and the results of the hearing aid selection and evaluation must be included. Hearing aid services are provided in accordance with 42 CFR 440.110.

(2) Dental Services

Covers fillings, extractions, restorative services, stainless steel space maintainers, prophylaxes, scaling and curettage, fluoride, x-rays, relief of pain, periodontal services, complete and partial dentures with rebasing and relining, endodontic therapy, surgery, and orthodontics in accordance with evidence-based best practices and/or where medical necessity dictates.

(4) Prosthetic and Orthotic Devices

Medically necessary orthotic and prosthetic devices are covered by the Medicaid program when prescribed by a qualified licensed healthcare practitioner and supplied by a qualified provider.

Only items determined to be medically necessary, effective and efficient are covered. Items which require prior approval are indicated by an asterisk beside the HCPCS code on the Orthotic and Prosthetic Fee Schedule. This fee schedule is located at [www.dhhs.state.nc.us/dma/fee/fee.htm](http://www.dhhs.state.nc.us/dma/fee/fee.htm).

A qualified orthotic and prosthetic device provider must be approved by the Division of Medical Assistance. The provider requirements are published in Medicaid Clinical Coverage Policies on the NC Division of Medical Assistance website ([www.dhhs.state.nc.us/dma/dme/5B.pdf](http://www.dhhs.state.nc.us/dma/dme/5B.pdf)).

Prior approval is required for certain orthotic and prosthetic devices. The decision to require prior approval for a specific procedure, product or service and the requirements that must be met for prior approval are based on evaluation of the factors such as: utilization; efficacy; safety; potential risk to patients; potential for misuse or abuse; high cost; the availability of more cost effective or equivalent procedures, products and services; and legislative mandate. High cost is cost in comparison to other covered items and related maintenance. Such a designation would usually be arrived at by a team of DMA staff from fiscal, programmatic and Program Integrity areas. Whether the recipient gets the item or not is dependent on the rationale for medical need and the unavailability of another less costly item that would adequately address the need. Session Law 2004-124 states "medically necessary prosthetics and orthotics are subject to prior approval and utilization review." Specific prior approval requirements are published in Medicaid Clinical Coverage Policies on the NC Division of Medical Assistance website ([www.dhhs.state.nc.us/dma/dme/5B.pdf](http://www.dhhs.state.nc.us/dma/dme/5B.pdf)).

*\*Adult Orthotic and Prosthetic Information is located at: Attachment 3.1-A.1, Page 15.*

(5) Selected Services Are Covered

Selected services include physical, occupational, speech, language pathology/audiology, and respiratory therapy. Services include but are not limited to: inpatient hospital; nursing facilities; and outpatient services in physician offices and hospitals; and local management entities, as well as locations defined by clinical policies.

Prior to treatment a screening service provided by a practitioner licensed according to North Carolina General Statute Chapter 90 must document that the treatment is medically necessary to correct or ameliorate any defects or chronic conditions.

The amount, duration and scope of the services must be expected to correct or ameliorate any defects or chronic conditions according to the referring treatment plan of care. These services must be provided in the most economical setting available according to clinical policies and limitations promulgated in accordance with Session Law 2001-424.

(6) The above listed services are covered as follows:

Other Diagnostic Screening, Preventive and Rehabilitative Services are reimbursed in accordance with Attachment 4.19-B. Clinic services, Hospital Outpatient services, Home Health Agencies and Physician Services are also reimbursed in accordance with Attachment 4.19-B.

The agency assures that if there are providers involved whose payment is based on reasonable cost, the State will provide appropriate cost reimbursement methodologies. The agency has waived the 6 prescription limit and the 24 visit limit for ambulatory visits for EPSDT eligible clients. The agency will cover all diagnostic and treatment services listed in 1905(a) which are medically necessary to correct or lessen health problems detected during screening. These services will be made available based on individual client needs.

(7) Assurance 1905(a) Services

The state assures that EPSDT eligible clients have access to 1905(A) services not specifically listed in the state plan when they are medically necessary. Services provided as described in Section 1905(a) to correct or ameliorate defects and physical and mental illnesses and conditions discovered by screening services and not covered in the state plan will be provided if determined to be medically necessary by the appropriate agency staff or consultants.

**4.b Early and periodic screening, diagnostic and treatment services for individuals under 21 years of age, and treatment of conditions found.**

- (8) Services provided under this section are provided by licensed practitioners (within their scope of practice as determined by the North Carolina Practice Acts per discipline) or programs/agencies for the mentally ill and substance abusers certified as meeting the program standards of the Commission on Mental Health, Developmental Disabilities and Substance Abuse Services or as Critical Access Behavioral Health Care Agencies, and directly enrolled in Medicaid. Staff of the agency providing services will also meet requirements set forth in Federal regulations or the requirements for one of the three categories described on pages 7c.10 and 7c.11. These services are available to categorically needy and medically needy recipients. Services include the following:

Medically necessary diagnostic evaluations or assessments (Diagnostic Assessment) identify the existence, nature and extent of illness. The services may include a systematic appraisal of mental, psychological, physical, behavioral, functional, social, economic and/or intellectual limitations and resources of the individual in order to determine the nature and extent of illness. This information will be used in the formulation of an individualized person centered plan for the recipient.

Other medically necessary diagnostic, screening, treatment, preventive and rehabilitative (ODSPR) services for the mentally ill and substance abusers are covered benefits when medically necessary. Screening services means the use of standardized tests given under medical direction. Diagnostic, preventive, or rehabilitative services must be ordered by a physician, licensed psychologist, physician's assistant or nurse practitioner practicing within the scope of his/her practice according to Chapter 90 of the North Carolina General Statutes. Specific-Services for children from age 0 to age 3 can be found at Attachment 3.1-A.1 page 7g.1 "*Early Intervention Rehabilitative Services.*"

Covered services are provided to recipients in their residence or in a community setting, which may be any location other than in a public institution (IMD), other inpatient setting, jail or detention facility.

Inpatient psychiatric facilities serving individuals under age 21 will meet the requirement of 42 Code of Federal Regulations Part 441, Subpart D, and Part 483, Subpart G.

Critical Access Behavioral Health Agencies (CABHA), for profit, not for profit, public, or private behavioral health care, behavioral health services provider agencies, will be certified by the North Carolina Department of Health and Human Services (the Department) as meeting the following staffing, and operational certification requirements.



4.b **Early and periodic screening, diagnostic and treatment services for individuals under 21 years of age, and treatment of conditions found. (continued)**

Critical Access Behavioral Health Agency (CABHA)

A Critical Access Behavioral Health Agency must meet all statutory, rule and policy requirements for Medicaid mental health and substance abuse service provision and monitoring; be determined to be in good standing with the Department; and have a three year (or longer) accreditation from an accrediting body recognized by the Secretary of the Department of Health and Human Services. State statutory requirements regulating the provision of mental health and substance abuse services are in North Carolina General Statute, Chapter 122C; administrative rules relating to these services are in 10A NCAC 27 and clinical policy requirements are specified in Medicaid Clinical Policy Section 8. Medicaid and enrollment policy require compliance with Federal Medicaid Policy relating to confidentiality, record retention, fraud and abuse reporting and education, documentation, staff qualifications and compliance with clinical standards for each service. Required staff for a CABHA includes a Medical Director; a Clinical Director and a Quality Management/Training Director.

4.b **Early and periodic screening, diagnostic and treatment services for individuals under 21 years of age, and treatment of conditions found. (continued)**

**Critical Access Behavioral Health Agency (CABHA) (continued)**

Each CABHA is required to offer at a minimum the following five services;

1. Comprehensive clinical assessment, which is defined as a face to face evaluative review by a qualified licensed practitioner, of a recipient’s medical, psychological, familial, social and psychiatric treatment history; current mental status and functioning, strengths, natural supports, current treatment and medication regime, for the purpose of developing a diagnostic formulation of the recipient’s treatment needs and treatment plan.; may be provided under Diagnostic Assessment, Attachment 3.1-A1, Page 7c.2 or under Rehabilitative Services for Behavioral Health, Page 7c.12 – 13.
2. Medication management defined as pharmacologic management including review of medication use, both current and historical, if indicated; evaluation of symptoms being treated, side effects and effectiveness of current medication(s), adjustment of medications if indicated, and prescription, provided by a medical professional practicing within the scope of his or her licensure; may be provided under Physician Services, Attachment 3.1-A.1, Page 7h or under Rehabilitative Services for Behavioral Health, Page 7c.12 – 13.
3. Outpatient therapy defined as outpatient psychotherapy including individual insight oriented, behavior modifying, and/or supportive psychotherapy; interactive psychotherapy; family psychotherapy; and group psychotherapy. Service can be billed by all licensed clinicians according to their scope of practice, as indicated on Attachment 3.1-A.1., page 7c.12 – 13.
- 4- At least two additional mental health and/or substance abuse services from the list below for which the agency has been credentialed from the Local Management Entity in the same region where it provides the services and which provide a continuum of service which is age and disability specific. There is a description of each of the services, including who provides the services and their qualifications in the State Plan in Attachment 3.1-A.1.,-on the page as indicated below.

These services must include two or more of the following:

Services	Page Reference
Intensive In-Home (IIH)	Page 7c.6
Community Support Team (CST)	Page 15a.6
Substance Abuse Intensive Outpatient Program (SAIOP)	Pages 7c.8 & 15a.9-A
Substance Abuse Comprehensive Outpatient Treatment (SACOT)	Page 15a.10
Child and Adolescent Day Treatment	Page 7c.4
Psychosocial Rehabilitation (PSR)	Page 15a.3
Assertive Community Treatment Team (ACTT)	15a.7
Multi-Systemic Therapy (MST)	Page 7c.7
Partial Hospitalization (PH)	Pages 7c.5 & 15a.4
Substance Abuse Medically Monitored Community Residential Treatment	Page 15a.11-A
Substance Abuse Non-Medical Community Residential Treatment	Page 15a.11
Outpatient Opioid Treatment	Page 15a.9
(Therapeutic Foster Care) Child Residential Level II – Family Type	Page 15a.19
Child Residential Level II – Program Type	Page 15a.19
Child Residential Level III and IV	Page 15a.20

CABHAs and non-CABHA agencies may provide Comprehensive Clinical Assessments, Medication Management, and Outpatient Therapy.

State Plan Under Title XIX of the Social Security Act  
Medical Assistance Program  
State: NORTH CAROLINA

---

**4.b Early and periodic screening, diagnostic and treatment services for individuals under 21 years of age, and treatment of conditions found. (continued)**

Only CABHAs will be able to provide Community Support Team, Intensive In-Home, Child and Adolescent Day Treatment after December 31, 2010.

CABHAs must coordinate with other provider participants, Carolina Access and other primary care providers to improve the coordination of services within the Local Management Entity's community of providers.

The following services under this section will be covered when a determination is made that the services are medically necessary and will meet specific behavioral health needs of the recipient. Specific services must correct or ameliorate diagnosable conditions or prevent the anticipated deterioration of the patient's condition. Services provided to family members of the recipient must be related to the recipient's mental health/substance abuse disability.

State Plan Under Title XIX of the Social Security Act  
Medical Assistance Program  
State: NORTH CAROLINA

---

4.b.(8) Diagnostic, Screening, Treatment, Preventive and Rehabilitative Services (continued)  
Description of Services

- (a) Psychotherapy Services:  
For the complete description of the service providers, their qualifications, service limitations and service descriptions, see Attachment 3.1-A pages 15a.16 and 15a.7
- (b) Diagnostic Assessment (42 CFR 440.130(a))

This is a clinical face to face evaluation of a beneficiary's MH/DD/SAS condition that will establish a need for the enhanced benefit package of services. It is a team service and must include evaluations by either, a physician, physician assistant, nurse practitioner or licensed psychologist who can sign an order for services and a licensed or certified practitioner with expertise in MH/DD/SAS as appropriate and consist of the following:

- a chronological general health and behavioral health history (includes both mental health and substance abuse) of the beneficiary's symptoms, treatment, treatment response and attitudes about treatment over time, emphasizing factors that have contributed to or inhibited previous recovery efforts; biological, psychological, familial, social, developmental and environmental dimensions and identified strengths and weaknesses in each area;
- a description of the presenting problems, including source of distress, precipitating events, associated problems or symptoms, recent progressions, and current medications;
- a strengths/problem summary which addresses risk of harm, functional status, co-morbidity, recovery environment, and treatment and recovery history;
- diagnoses on all five (5) axes of DSM-IV;
- evidence of an interdisciplinary team progress note that documents the team's review and discussion of the assessment;
- a recommendation regarding target population eligibility; and
- evidence of beneficiary participation including families, or when applicable, guardians or other caregivers.

Documentation must include the following elements:

- a chronological general health and behavioral health history (includes both mental health and substance abuse) of the beneficiary's symptoms, treatment, treatment response and attitudes about treatment over time, emphasizing factors that have contributed to or inhibited previous recovery efforts; biological, psychological, familial, social, developmental and environmental dimensions and identified strengths and weaknesses in each area;
- a description of the presenting problems, including source of distress, precipitating events, associated problems or symptoms, recent progressions, and current medications;
- strengths/problem summary which addresses risk of harm, functional status, co-morbidity, recovery environment, and treatment and recovery history;
- diagnoses on all five (5) axes of DSM-IV;
- evidence of an interdisciplinary team progress note that documents the team's review and discussion of the assessment;
- a recommendation regarding target population eligibility; and
- evidence of beneficiary participation including families, or when applicable, guardians or other caregivers.

A beneficiary may receive one diagnostic assessment per year without any additional authorization.

State Plan Under Title XIX of the Social Security Act  
Medical Assistance Program  
State: NORTH CAROLINA

---

---

INTENTIONALLY LEFT BLANK

---

TN No: 12-009  
Supersedes  
TN No: 10-017

Approval Date: 10-17-12

Effective Date: 07/01/2012

State Plan Under Title XIX of the Social Security Act  
Medical Assistance Program  
State: NORTH CAROLINA

---

INTENTIONALLY LEFT BLANK

---

TN No: 12-009  
Supersedes  
TN No: 09-025

Approval Date: 10-17-12

Effective Date: 07/01/2012

State Plan Under Title XIX of the Social Security Act  
Medical Assistance Program  
State: NORTH CAROLINA

---

---

INTENTIONALLY LEFT BLANK

---

TN No: 12-009  
Supersedes  
TN No: 09-025

Approval Date: 10-17-12

Effective Date: 07/01/2012

State Plan Under Title XIX of the Social Security Act  
Medical Assistance Program  
State: NORTH CAROLINA

---

---

INTENTIONALLY LEFT BLANK

---

TN No: 12-009  
Supersedes  
TN No: 09-025

Approval Date: 10-17-12

Effective Date: 07/01/2012



State Plan Under Title XIX of the Social Security Act  
Medical Assistance Program  
State: NORTH CAROLINA

---

---

INTENTIONALLY LEFT BLANK

---

TN No: 12-009  
Supersedes  
TN No: 09-025

Approval Date: 10-17-12

Effective Date: 07/01/2012

State Plan Under Title XIX of the Social Security Act  
Medical Assistance Program  
State: NORTH CAROLINA

---

---

INTENTIONALLY LEFT BLANK

---

TN No: 12-009  
Supersedes  
TN No: 09-017

Approval Date: 10-17-12

Effective Date: 07/01/2012

State Plan Under Title XIX of the Social Security Act  
Medical Assistance Program  
State: NORTH CAROLINA

---

---

INTENTIONALLY LEFT BLANK

---

TN No: 12-009  
Supersedes  
TN No: 09-025

Approval Date: 10-17-12

Effective Date: 07/01/2012

State Plan Under Title XIX of the Social Security Act  
Medical Assistance Program  
State: NORTH CAROLINA

---

---

INTENTIONALLY LEFT BLANK

---

TN No: 12-009  
Supersedes  
TN No: 09-025

Approval Date: 10-17-12

Effective Date: 07/01/2012

State Plan Under Title XIX of the Social Security Act  
Medical Assistance Program  
State: NORTH CAROLINA

---

---

INTENTIONALLY LEFT BLANK

---

TN No: 12-009  
Supersedes  
TN No: 09-025

Approval Date: 10-17-12

Effective Date: 07/01/2012

State Plan Under Title XIX of the Social Security Act  
Medical Assistance Program  
State: NORTH CAROLINA

---

INTENTIONALLY LEFT BLANK

---

TN No: 12-009  
Supersedes  
TN No: 09-025

Approval Date: 10-17-12

Effective Date: 07/01/2012

State Plan Under Title XIX of the Social Security Act  
Medical Assistance Program  
State: NORTH CAROLINA

---

INTENTIONALLY LEFT BLANK

---

TN No: 12-009  
Supersedes  
TN No: 09-025

Approval Date: 10-17-12

Effective Date: 07/01/2012

State Plan Under Title XIX of the Social Security Act  
Medical Assistance Program  
State: NORTH CAROLINA

---

INTENTIONALLY LEFT BLANK

---

TN No: 12-009  
Supersedes  
TN No: 09-025

Approval Date: 10-17-12

Effective Date: 07/01/2012



**4.b Early and periodic screening, diagnostic and treatment services for individuals under 21 years of age, and treatment of conditions found. (continued)**

(d) Mental Health Day Treatment

This service is available for children from age 3 up through age 20 and includes therapeutic or rehabilitation goals of the consumer in a structured setting. The interventions are outlined in the child/adolescent person centered treatment plan and may include:

- behavioral interventions,
- social and other skill development,
- communication enhancement,
- problem- solving skills,
- anger management,
- monitoring of psychiatric symptoms; and
- psycho-educational activities as appropriate.

These interventions are designed to support symptom stability, increase the recipient's ability to cope and relate to others and enhancing the highest level of functioning possible. The service will also contain a care coordination component with assessment, monitoring, linking to services related to mental health needs and coordination of mental health services. Documentation must include: a daily full service note that includes the recipient's name, Medicaid identification number, date of service, purpose of contact, describes the provider's interventions, includes the time spent performing the interventions, effectiveness of the intervention, and the signature of the staff providing the service. This service must be available three hours a day minimally in a licensed program. After December 31, 2010, this service can only be provided by and billed by a Critical Access Behavioral Health Care Agency (CABHA). All services in the milieu are provided by a team which may have the following configuration; providers meet the qualified professional requirements, associate professionals and paraprofessionals. The service must be ordered by a physician, licensed psychologists, physician's assistant or nurse practitioner and prior approval will be required via the statewide UR vendor or by an approved LME, contracted with the Medicaid Agency and meeting the same standards and requirements as the statewide vendor. This initial prior approval process will ensure that the level of the service is appropriate and concurrent reviews will determine the ongoing medical necessity for the service or the need to move up or down the continuum of services to another level of care. This service can only be provided by one day treatment provider at a time and cannot be billed on the same day as any inpatient, residential, or any other intensive in home service.

4.b.(8) Diagnostic, Screening, Treatment, Preventive and Rehabilitative Services (continued)  
Description of Services

(e) Partial Hospital (PH)

This is a short term service for acutely mentally ill children which provides a broad range of intensive therapeutic approaches which may include:

- Individual/group therapies,
- Increase the individual's ability to relate to others,
- Community living skills/training,
- Coping skills,
- Medical services; and
- This is used as a step up to inpatient or a step down from inpatient.

Physician involvement is required. This service must be offered at a minimum of 4 hours per day, 5 days/week. Clinical criteria (medical necessity criteria for admission and continued stay) are embedded in the service definition. Documentation must include: a daily full service note that includes the recipient's name, Medicaid identification number, date of service, purpose of contact, describes the provider's interventions, includes the time spent performing the interventions, effectiveness of the intervention, and the signature of the staff providing the service. The service must be ordered by a physician, licensed psychologists, physician's assistant or nurse practitioner and prior approval will be required via the statewide UR vendor or by an approved LME contracted with the Medicaid Agency and meeting the same standards and requirements as the statewide vendor. This initial prior approval process will ensure that the level of the service is appropriate and concurrent reviews will determine the ongoing medical necessity for the service or the need to move up or down the continuum of services to another level of care.

Provider agencies for Partial Hospitalization are licensed by the Division of Health Service Regulation, credentialed by the LMEs as meeting the program specific requirements for provision of Partial Hospitalization and enrolled in Medicaid. The staff providing this service are employees of the enrolled agency. Their qualifications and the discrete service components they perform are listed below.

All services in the Partial Hospital are provided by a team, which may have the following configuration: social workers, psychologists, therapists, case managers, or other MH/SA paraprofessional staff. The partial hospital milieu is directed under the supervision of a physician. Staff shall include at least one qualified mental health professional.

The following sets forth the activities included in this service definition. These activities reflect the appropriate scope of practice for the Partial Hospital staff identified below.

Physician: Participate in diagnosis, treatment planning, and admission/discharge decisions.

Social Workers, Psychologists, therapists: Group activities and therapy such as individual therapy and recreational therapy.

Case Managers: Case Management functions

Paraprofessional staff: Community living skills/training under the supervision of a Qualified Professional.

4.b.(8) Diagnostic, Screening, Treatment, Preventive and Rehabilitative Services (continued)  
Description of Services

(f) Mobile Crisis Management

This involves all supports, services and treatments necessary to provide integrated crisis response, crisis stabilization interventions and crisis prevention activities. It is available 24/7/365 and provides immediate evaluation, triage and access to acute MH/DD/SAS services, treatment, supports to effect symptom reduction, harm reduction and/or to safely transition persons in acute crisis to the appropriate environment for stabilization. It is provided by a team that includes a Qualified Professional who must be either, a nurse, a clinical social worker or psychologist. Teams include substance abuse professionals, and a psychiatrist must be available for face to face or telephone consults. Paraprofessionals with crisis management experience may also be included on the team but must work under the supervision of a professional. Experience with the appropriate disability group is required and 20 hours of crisis intervention training within the first 90 days of employment is necessary. The maximum length of the service is 24 hours per episode and prior authorization will be required after the first 8 hours for the remaining 16 hours. Documentation must include: a service note that includes the recipient's name, Medicaid identification number, date of service, purpose of contact, describes the provider's interventions, includes the time spent performing the interventions, effectiveness of the intervention, and the signature of the staff providing the service.

NOTE: This has a limitation; however the service requires stabilization or movement into an environment that can stabilize so it is not really a termination of service.

**4.b Early and periodic screening, diagnostic and treatment services for individuals under 21 years of age, and treatment of conditions found. (continued)**

(g) Intensive In-Home

A time limited mental health/substance abuse service that can be provided through age 20 in order to:

- diffuse current crisis as a first responder,
- intervene to reduce likelihood of re-occurrence,
- ensure linkage to community services and resources,
- monitor and manage presenting psychiatric and/or addictions,
- provide self-help and living skills for youth; and
- work with caregivers in implementation of home-based supports and other rehabilitative supports to prevent out of home placement for the child.

This is a team service provided by qualified professionals, associate professionals and paraprofessionals. There is a team to family ratio to keep case load manageable and staff must complete intensive in home training with in the first 90 days of employment. Services are provided in the home or community and not billable for children in detention or inpatient settings. The service requires a minimum of 12 face to face contacts the first month with a contact being defined as all visits within a 24 hour period. A minimum of 2 hours of service must be provided each day for the service to be billable. Number of visits per month for the second and third month of the service will be titrated with the expectation of six visits per month. Documentation must include: a daily full service note that includes the recipient's name, Medicaid identification number, date of service, purpose of contact, describes the provider's interventions, includes the time spent performing the interventions, effectiveness of the intervention, and the signature of the staff providing the service. After December 31, 2010, this service can only be provided by and billed by a Critical Access Behavioral Health Care Agency (CABHA). The service must be ordered by a physician, licensed psychologists, physician's assistant or nurse practitioner and prior approval will be required via the statewide UR vendor or by an approved LME contracted with the Medicaid Agency and meeting the same standards and requirements as the statewide vendor. This initial prior approval process will ensure that the level of the service is appropriate and concurrent reviews will determine the ongoing medical necessity for the service or the need to move up or down the continuum of services to another level of care.

This service can only be provided by one Intensive In-Home provider at the time and cannot be billed on the same day as Multisystemic Therapy, Day Treatment, Hourly Respite, Individual, group or family therapy, SAIOP, or living in a Level II-IV child residential (Attachment 3.1-A.1, Pages 15a.19-20) or substance abuse residential facility.

State Plan Under Title XIX of the Social Security Act  
Medical Assistance Program  
State: NORTH CAROLINA

---

4.b.(8) Diagnostic, Screening, Treatment, Preventive and Rehabilitative Services (continued)  
Description of Services

(h) Multisystemic Therapy (MST)

This mental health/substance abuse program is an evidenced-based practice designed for youth generally between the ages of 7 and 17 who have antisocial, aggressive/violent behaviors and are at risk for out of home placement due to delinquency; adjudicated youth returning from out of home placement and/or chronic or violent juvenile offenders; and youths with serious emotional disturbances or abusing substances. As required by EPSDT, youth outside of these age ranges would be able to receive the service if medically necessary and if no other more appropriate service is available. This is a team service that has the ability to provide service 24/7/365. The service components include assessment, individual therapeutic interventions with the youth and family, care coordination, and crisis stabilization. Specialized therapeutic interventions are available to address special areas such as substance abuse, sexual abuse, sex offending, and domestic violence. Services are available in-home, at school, and in other community settings. The duration of MST intervention is 3 to 5 months. MST involves families and other systems such as the school, probation officers, extended families, and community connections. The service must be ordered by a physician, licensed psychologists, physician's assistant or nurse practitioner and prior approval will be required via the statewide UR vendor or by an approved LME contracted with the Medicaid Agency and meeting the same standards and requirements as the statewide vendor. This initial prior approval process will ensure that the level of the service is appropriate and concurrent reviews will determine the ongoing medical necessity for the service or the need to move up or down the continuum of services to another level of care.

Recipients residing in detention facilities, halfway houses or wilderness camps under governmental control, an inmate receiving outpatient treatment, or receiving care on premises of prison, jail, detention center, or other penal setting are not eligible for receiving any Medicaid Federal Financial Participation (FFP) through MST or any other Medicaid funded service.

A minimum of 12 contacts are required within the first month of the service and for the next two months an average of 6 contacts per month will occur. It is the expectation that service frequency will be titrated over the last two months. Documentation must include: a daily full service note that includes the recipient's name, Medicaid identification number, date of service, purpose of contact, describes the provider's interventions, includes the time spent performing the interventions, effectiveness of the intervention, and the signature of the staff providing the service.

Clinical criteria (medical necessity criteria for admission and continued stay) are embedded in the service definition. The provider qualifications are at a minimum a master's level Qualified Professional (QP) who is the team supervisor and three QP staff as defined in State rule 10A NCAC 27G .0104 as follows:

- (a) an individual who holds a license, provisional license, certificate, registration or permit issued by the governing board regulating a human service profession, except a registered nurse who is licensed to practice in the State of North Carolina by the North Carolina Board of Nursing who also has four years of full-time accumulated experience in MH/DD/SA with the population served; or

---

TN No.: 11-005  
Supersedes  
TN No.: 09-017

Approval Date: 08-19-11

Effective Date: 04/01/2011

State Plan Under Title XIX of the Social Security Act  
Medical Assistance Program  
State: NORTH CAROLINA

=====

(b) a graduate of a college or university with a Masters degree in a human service field and has one year of full-time, post-graduate degree accumulated MH/DD/SA experience with the population served, or a substance abuse professional who has one year of full-time, post-graduate degree accumulated supervised experience in alcoholism and drug abuse counseling; or

(c) a graduate of a college or university with a bachelor's degree in a human service field and has two years of full-time, post-bachelor's degree accumulated MH/DD/SA experience with the population served, or a substance abuse professional who has two years of full-time, post-bachelor's degree accumulated supervised experience in alcoholism and drug abuse counseling; or

(d) a graduate of a college or university with a bachelor's degree in a field other than human services and has four years of full-time, post-bachelor's degree accumulated MH/DD/SA experience with the population served, or a substance abuse professional who has four years of full-time, post-bachelor's degree accumulated supervised experience in alcoholism and drug abuse counseling.

Providers wish to offer MST as a service must be credentialed by their Local Management Entity, be licensed by MST Inc, and be enrolled as a North Carolina Medicaid provider. These providers agree to adhere to the principles of MST.

Staff is required to participate in MST introductory training and quarterly training on topics related to the needs of MST youth and their family on an ongoing basis. All MST staff shall receive a minimum of one hour of group supervision and one hour of telephone consultation per week from specially trained MST supervisors. Limitations are in place to prevent reimbursement for duplication of services.

4.b.(8) Diagnostic, Screening, Treatment, Preventive and Rehabilitative Services (continued)  
Description of Services

(i) Substance Abuse Intensive Outpatient (SAIOP)

This service provides motivational enhancement and engagement therapies for recovery, random alcohol/drug testing and strategies for relapse prevention to include community and/or other strategies for relapse preventions. These therapies include:

- Individual counseling and support,
- Group counseling and support,
- Family counseling and support,
- Biochemical assays to identify recent drug use (e.g. urine drug screens),
- Strategies for relapse prevention: community and social support systems in treatment,
- Crisis contingency planning,
- Disease management; and
- Treatment support activities that have been adapted or specifically designed for persons with physical disabilities or persons with co-occurring disorders of mental illness and/or developmental disabilities and/or substance abuse/dependence.

Family counseling and support as well as group counseling and support are provided only for the direct benefit of the recipient of the SAIOP program.

SAIOP must be available for a minimum of 3 hours per day, be operated out of a licensed substance abuse facility and can be provided in a variety of settings. The maximum face to face ratio is an average of not more than 12 recipients to 1 direct services staff based on average daily attendance. Documentation must include: a service note that includes the recipient's name, Medicaid identification number, date of service, purpose of contact, describes the provider's interventions, includes the time spent performing the interventions, effectiveness of the intervention, and the signature of the staff providing the service. This service can only be provided by qualified substance abuse professional staff with the following licenses or certifications: Licensed Psychological Associates, Licensed Professional Counselors, Licensed Clinical Social Workers, Certified Substance Abuse Counselors, and Licensed Clinical Addiction Specialists. This service must be ordered by an MD, NP, PA or PhD psychologist. Prior approval will be required via the statewide UR vendor or by an approved LME contracted with the Medicaid Agency and meeting the same standards and requirements as the statewide vendor. This initial prior approval process will ensure that the level of the service is appropriate and concurrent reviews will determine the ongoing medical necessity for the service or the need to move up or down the continuum of services to another level of care.

State Plan Under Title XIX of the Social Security Act  
Medical Assistance Program  
State: NORTH CAROLINA

---

4.b.(8) Diagnostic, Screening, Treatment, Preventive and Rehabilitative Services (continued)  
Description of Services

(j) Ambulatory Detoxification

Ambulatory Detoxification is an organized service available to children and adults, delivered by trained practitioners who provide medically supervised evaluations, detoxification and referral services according to a predetermined schedule. Medical supervision consists of a physician available 24 hours a day by telephone, a registered nurse who monitors the recipient's progress and medication, and appropriately licensed and credentialed staff to administer medications in accordance with physician orders. Ambulatory Detoxification service components include outpatient services delivered by trained clinicians, who provide medically supervised evaluation, detoxification and referral services according to a predetermined schedule. Such services are provided in regularly scheduled sessions. The services are designed to treat the patient's level of clinical severity and to achieve safe and comfortable withdrawal from mood-altering drugs (including alcohol) and to effectively facilitate the patient's transition into ongoing treatment and recovery. These services are provided in a licensed facility with regularly scheduled sessions by a Certified Clinical Supervisor (CCS), Licensed Clinical Addictions Specialist (LCAS), Qualified Professional (QP) or Associate Professional (AP). A CCS is an individual who is certified as such by the North Carolina Substance Abuse Professional Certification Board. A LCAS is certified as such by the North Carolina Substance Abuse Professional Certification Board. The Qualified Professional is:

- (a) an individual who holds a license, provisional license, certificate, registration or permit issued by the governing board regulating a human service profession, except a registered nurse who is licensed to practice in the State of North Carolina by the North Carolina Board of Nursing who also has four years of full-time accumulated experience in MH/DD/SA with the population served; or
- (b) a graduate of a college or university with a Masters degree in a human service field and has one year of full-time, post-graduate degree accumulated MH/DD/SA experience with the population served, or a substance abuse professional who has one year of full-time, post-graduate degree accumulated supervised experience in alcoholism and drug abuse counseling; or
- (c) a graduate of a college or university with a bachelor's degree in a human service field and has two years of full-time, post-bachelor's degree accumulated MH/DD/SA experience with the population served, or a substance abuse professional who has two years of full-time, post-bachelor's degree accumulated supervised experience in alcoholism and drug abuse counseling; or
- (d) a graduate of a college or university with a bachelor's degree in a field other than human services and has four years of full-time, post-bachelor's degree accumulated MH/DD/SA experience with the population served, or a substance abuse professional who has four years of full-time, post-bachelor's degree accumulated supervised experience in alcoholism and drug abuse counseling.

An AP within the mental health, developmental disabilities and substance abuse services (MH/DD/SAs) system of care is a:

---

TN No.: 11-005  
Supersedes  
TN No.: 05-005

Approval Date: 08-19-11

Effective Date: 04/01/2011



State Plan Under Title XIX of the Social Security Act  
Medical Assistance Program  
State: NORTH CAROLINA

---

4.b.(8) Diagnostic, Screening, Treatment, Preventive and Rehabilitative Services (continued)

Description of Services

(a) graduate of a college or university with a Masters degree in a human service field with less than one year of full-time, post-graduate degree accumulated MH/DD/SA experience with the population served, or a substance abuse professional with less than one year of full-time, post-graduate degree accumulated supervised experience in alcoholism and drug abuse counseling. Supervision shall be provided by a qualified professional with the population served until the individual meets one year of experience. The supervisor and the employee shall develop an individualized supervision plan upon hiring. The parties shall review the plan annually; or

(b) graduate of a college or university with a bachelor's degree in a human service field with less than two years of full-time, post-bachelor's degree accumulated MH/DD/SA experience with the population served, or a substance abuse professional with less than two years of full-time, post-bachelor's degree accumulated supervised experience in alcoholism and drug abuse counseling. Supervision shall be provided by a qualified professional with the population served until the individual meets two years of experience. The supervisor and the employee shall develop an individualized supervision plan upon hiring. The parties shall review the plan annually; or

(c) graduate of a college or university with a bachelor's degree in a field other than human services with less than four years of full-time, post-bachelor's degree accumulated MH/DD/SA experience with the population served, or a substance abuse professional with less than four years of full-time, post-bachelor's degree accumulated supervised experience in alcoholism and drug abuse counseling. Supervision shall be provided by a qualified professional with the population served until the individual meets four years of experience. The supervisor and the employee shall develop an individualized supervision plan upon hiring. The parties shall review the plan annually; or

(d) registered nurse who is licensed to practice in the State of North Carolina by the North Carolina Board of Nursing with less than four years of full-time accumulated experience in MH/DD/SA with the population served. Supervision shall be provided by a qualified professional with the population served until the individual meets four years of experience. The supervisor and the employee shall develop an individualized supervision plan upon hiring. The parties shall review the plan annually.

Ambulatory Detoxification is an outpatient service that provides periodic services involving the provision of supportive services, particularly active support systems under the supervision of a physician for clients who are experiencing physical withdrawal from alcohol and other drugs, including but not limited to appropriate medical, nursing and specialized substance abuse services. This service must be provided in an Ambulatory Detoxification Facility licensed under 10A NCAC 27G .3301. Each outpatient detoxification facility shall operate at least eight hours per day, for a minimum of five days per week.

---

TN No.: 11-005  
Supersedes  
TN No.: NEW

Approval Date: 08-19-11

Effective Date: 04/01/2011

State Plan Under Title XIX of the Social Security Act  
Medical Assistance Program  
State: NORTH CAROLINA

---

4.b.(8) Diagnostic, Screening, Treatment, Preventive and Rehabilitative Services (continued)  
Description of Services

Documentation must include: a service note that includes the recipient's name, Medicaid identification number, date of service, purpose of contact, describes the provider's interventions, includes the time spent performing the interventions, effectiveness of the intervention, and the signature of the staff providing the service. A physician is available 24/7 to conduct an assessment within 24 hours of admission. A registered nurse is available to conduct a nursing assessment on admission and oversee the monitoring of patient's progress and medications. This service must be ordered by an MD, NP, PA or PhD psychologist. Prior approval will be required via the statewide UR vendor or by an approved LME contracted with the Medicaid Agency and meeting the same standards and requirements as the statewide vendor. This initial prior approval process will ensure that the level of the service is appropriate and concurrent reviews will determine the ongoing medical necessity for the service or the need to move up or down the continuum of services to another level of care.

4.b.(8) Diagnostic, Screening, Treatment, Preventive and Rehabilitative Services (continued)  
Description of Services

(k) Professional Treatment Services in Facility-Based Crisis Program – Children and Adolescents

Professional Treatment Services in a Facility-Based Crisis Program – Children and Adolescents is a service for children and adolescents up to age 21 who meet the medical necessity criteria for crisis stabilization services furnished in a 24-hour residential facility, licensed under 10A NCAC 27G .5000, with 16 beds or less (the 16 bed limit is inclusive of Facility-Based Crisis -- Adult and Facility-Based Crisis -- Child). A Facility-Based Crisis provider shall be designated as an involuntary treatment facility. The Facility-Based Crisis Program is under the clinical oversight of a psychiatrist. This is a short term service that provides disability-specific care and treatment in a non-hospital setting for individuals requiring acute crisis stabilization. The goals of this service include:

- reduction of acute psychiatric symptoms that precipitated the need for this service,
- reduction of acute negative effects of substance related disorders with enhanced motivation for treatment and/or relapse prevention,
- stabilizing or managing the crisis situation,
- preventing hospitalization or other institutionalization,
- accessing services as indicated in the comprehensive clinical assessment, and
- reduction of behaviors that led to the crisis.

A comprehensive clinical assessment is an intensive clinical and functional face-to-face evaluation of an individual's presenting mental health, developmental disability, and/or substance abuse condition that result in the issuance of a written report, providing the clinical basis for the development of the Person Centered Plan. The comprehensive clinical assessment is provided by a directly enrolled licensed professional as outlined in the Division of Medical Assistance Clinical Coverage Policy 8C.

This crisis stabilization service includes a comprehensive clinical assessment, treatment intervention (which may include the development and implementation of a behavior management or support plan), and aftercare planning.

Treatment interventions include:

- intensive treatment, behavior management support and interventions, detoxification protocols as addressed in the recipient's service plan;
- active engagement of the family, caregiver and/or legally responsible person in crisis stabilization and treatment interventions as appropriate;
- stabilization of the immediate presenting issues, behaviors or symptoms that have resulted in the need for crisis intervention or detoxification; and
- monitoring of his/her medical condition and response to the treatment protocol to ensure the safety of the individual.

4.b.(8) Diagnostic, Screening, Treatment, Preventive and Rehabilitative Services (continued)  
Description of Services

(k) Professional Treatment Services in Facility-Based Crisis Program – Children and Adolescents  
(continued)

The staff member responsible for furnishing the above treatment interventions shall be selected from the list of qualified providers on pages 7c.9b, 7c.9c and 7c.9d, based on their qualifications and scope of practice, and will be specified in the Person Centered Plan. Each facility shall have staff ratios, trained staff, and protocols and procedures in conformance with State policies and rules.

Aftercare planning includes: (aftercare planning is the responsibility of the Qualified Professional)

Discharge planning which begins at admission, including:

- arranging for linkage to new or existing services that will provide further treatment, habilitation and/or rehabilitation upon discharge from the Facility-Based Crisis service;
- arranging for linkage to a higher level of care as medically necessary;
- identifying, linking to, and collaborating with informal and natural supports in the community; and
- developing or revising the crisis plan to assist the recipient and his or her supports in preventing and managing future crisis events.

This is a short-term service that is not reimbursable for more than 30 days in a calendar year. This service is designed as a time-limited alternative to hospitalization for an individual in crisis.

Providers are required to staff programs according to population designation above. Staff eligible to provide this service include: Board-eligible or board certified child psychiatrist or a general psychiatrist with a minimum of two years experience in the treatment of children and adolescents, Licensed Practicing Psychologists, Licensed Professionals (Licensed Clinical Social Workers, Licensed Professional Counselors, Licensed Clinical Addiction Specialists, Licensed Marriage and Family Therapists, Registered Nurses, Licensed Practical Nurse, Qualified Professionals, Associate Professional and/or Paraprofessionals with disability-specific knowledge, skills, and abilities required by the population and age to be served. Associate Professionals and Paraprofessionals will be supervised according to 10A NCAC 27G .0203 - .0204. The program shall be under the supervision of a psychiatrist, the licensed professional provides clinical supervision to the program, and the program shall have the capacity to provide more intensive supervision in response to the needs of individual clients.

Associate Professional (AP) within the mental health, developmental disabilities and substance abuse services (MH/DD/SAS) system of care means an individual who is a:

---

4.b.(8) Diagnostic, Screening, Treatment, Preventive and Rehabilitative Services (continued)  
Description of Services

(k) Professional Treatment Services in Facility-Based Crisis Program – Children and Adolescents  
(continued)

(a) graduate of a college or university with a Masters degree in a human service field with less than one year of full-time, post-graduate degree accumulated MH/DD/SAS experience with the population served, or a substance abuse professional with less than one year of full-time, post-graduate degree accumulated supervised experience in alcoholism and drug abuse counseling. Supervision shall be provided by a qualified professional with the population served until the individual meets one year of experience. The supervisor and the employee shall develop an individualized supervision plan upon hiring. The parties shall review the plan annually; or

(b) graduate of a college or university with a bachelor's degree in a human service field with less than two years of full-time, post-bachelor's degree accumulated MH/DD/SAS experience with the population served, or a substance abuse professional with less than two years of full-time, post-bachelor's degree accumulated supervised experience in alcoholism and drug abuse counseling. Supervision shall be provided by a qualified professional with the population served until the individual meets two years of experience. The supervisor and the employee shall develop an individualized supervision plan upon hiring. The parties shall review the plan annually; or

(c) graduate of a college or university with a bachelor's degree in a field other than human services with less than four years of full-time, post-bachelor's degree accumulated MH/DD/SAS experience with the population served, or a substance abuse professional with less than four years of full-time, post-bachelor's degree accumulated supervised experience in alcoholism and drug abuse counseling. Supervision shall be provided by a qualified professional with the population served until the individual meets four years of experience. The supervisor and the employee shall develop an individualized supervision plan upon hiring. The parties shall review the plan annually; or

(d) Registered Nurse who is licensed to practice in the State of North Carolina by the North Carolina Board of Nursing with less than four years of full-time accumulated experience in MH/DD/SAS with the population served. Supervision shall be provided by a qualified professional with the population served until the individual meets four years of experience. The supervisor and the employee shall develop an individualized supervision plan upon hiring. The parties shall review the plan annually.

Paraprofessional (PP) within the MH/DD/SAS system of care means an individual who, with the exception of staff providing respite services or personal care services, has a GED or high school diploma; or no GED or high school diploma, employed prior to November 1, 2001 to provide a MH/DD/SAS service. Supervision shall be provided by a qualified professional or associate professional with the population served. The supervisor and the employee shall develop an individualized supervision plan upon hiring. The parties shall review the plan annually.

4.b.(8) Diagnostic, Screening, Treatment, Preventive and Rehabilitative Services (continued)  
Description of Services

(k) Professional Treatment Services in Facility-Based Crisis Program – Children and Adolescents  
(continued)

Qualified Professional (QP) means, within the MH/DD/SAS system of care:

- (a) an individual who holds a license, provisional license, certificate, registration or permit issued by the governing board regulating a human service profession, except a registered nurse who is licensed to practice in the State of North Carolina by the North Carolina Board of Nursing who also has four years of full-time accumulated experience in MH/DD/SAS with the population served.

The Licensed Qualified Professional will be a Licensed Professional (LP) holding a valid license issued by the governing board regulating a human service profession in the State of North Carolina. Individuals licensed as a Clinical Addiction Specialist, Clinical Social Worker, Marriage and Family Therapist, Professional Counselor, Psychiatrist, or Psychologist. The specific requirements for each of the above licensed professionals are listed below.

- Licensed Clinical Addiction Specialist means an individual who is licensed as such by the North Carolina Substance Abuse Professional Practice Board.
- Licensed Clinical Social Worker means a social worker who is licensed as such by the N.C. Social Work Certification and Licensure Board.
- Licensed marriage and family therapist means an individual who is licensed as such by the North Carolina Marriage and Family Licensing Board.
- Licensed Professional Counselor (LPC) means a counselor who is licensed as such by the North Carolina Board of Licensed Professional Counselors.
- Psychiatrist means an individual who is licensed to practice medicine in the State of North Carolina and who has completed a training program in psychiatry accredited by the Accreditation Council for Graduate Medical Education.
- Psychologist means an individual who is licensed to practice psychology in the State of North Carolina as either a licensed psychologist or a licensed psychological associate, or

If not licensed, the QP will be:

- (b) a graduate of a college or university with a Masters degree in a human service field and has one year of full-time, post-graduate degree accumulated MH/DD/SAS experience with the population served, or a substance abuse professional who has one year of full-time, post-graduate degree accumulated supervised experience in alcoholism and drug abuse counseling; or

- (c) a graduate of a college or university with a bachelor's degree in a human service field and has two years of full-time, post-bachelor's degree accumulated MH/DD/SAS experience with the population served, or a substance abuse professional who has two years of full-time, post-bachelor's degree accumulated supervised experience in alcoholism and drug abuse counseling; or

4.b.(8) Diagnostic, Screening, Treatment, Preventive and Rehabilitative Services (continued)  
Description of Services

(k) Professional Treatment Services in Facility-Based Crisis Program – Children and Adolescents  
(continued)

(d) a graduate of a college or university with a bachelor's degree in a field other than human services and has four years of full-time, post-bachelor's degree accumulated MH/DD/SAS experience with the population served, or a substance abuse professional who has four years of full-time, post-bachelor's degree accumulated supervised experience in alcoholism and drug abuse counseling.

Degrees in a human service field, include but are not limited to, the following degrees: psychology, social work, mental health counseling, rehabilitation counseling, addictions, psychiatric nursing, special education and therapeutic recreation.

The Facility Based Crisis program must address the age, behavior, and developmental functioning of each recipient to ensure safety, health and appropriate treatment interventions within the program milieu. The facility must ensure the physical separation of children from adolescents by living quarters, common areas, and in treatment, etc. If adults and children are receiving services in the same building, the facility must ensure complete physical separation between adults and children. All facilities serving both children and adults shall have 16 beds or less. Each facility must be staffed at a minimum of a psychiatrist, a registered nurse (24 hours/day), and an additional licensed professional. A physician is available 24/7 and must conduct a psychiatric assessment within 24 hours of admission. A registered nurse must conduct a nursing assessment on admission and oversee the monitoring of patient's progress and medications. A licensed professional must conduct a comprehensive clinical assessment upon admission. Treatment interventions may be performed by all staff based on their qualifications and/or scope of practice. Aftercare planning may be performed by any Qualified Professional.

This service must be ordered by an MD, NP, PA or PhD psychologist. Prior approval will be required via the statewide UR vendor or by an approved LME contracted with the Medicaid Agency and meeting the same standards and requirements as the statewide vendor. This initial prior approval process will ensure that the level of the service is appropriate and concurrent reviews will determine the ongoing medical necessity for the service or the need to move up or down the continuum of services to another level of care. Documentation must include: a service note that includes the recipient's name, Medicaid identification number, date of service, purpose of contact, describes the provider's interventions, includes the time spent performing the interventions, effectiveness of the intervention, and the signature of the staff providing the service. Facility Based Crisis is not available for:

- a. room and board services;
- b. educational, vocational and job training services;
- c. habilitation services;
- d. services to inmates in public institutions as defined in 42 CFR §435.1010;
- e. services to individuals residing in institutions for mental diseases as described in 42 CFR§435.1010;
- f. recreational and social activities; and
- g. services that must be covered elsewhere in the state Medicaid plan.

4.b.(9) Behavioral Health Rehabilitative Services (continued)

(d) Provider Qualifications for Staff Employed by Agencies Enrolled with Medicaid

Providers will meet either the appropriate Federal regulations or the requirements for one of the three categories described on pages 7c.10 and 7c.11.

i) Paraprofessional

“Paraprofessional” within the mental health and substance system means an individual who has a GED or high school diploma (or no GED or high school diploma if employed prior to November 1, 2001). Supervision shall be provided by a qualified professional or associate professional with the population served.

ii) Associate Professional (AP)

“Associate Professional” within the mental health and substance abuse services system means an individual who is a:

- graduate of college or university with a Masters degree in a human service field and less than one year of full time post-graduate mental health or substance abuse experience with the population served or a substance abuse professional with less than one year of full-time, post-graduate degree supervised experience in alcoholism and drug abuse counseling. Supervision shall be provided by a qualified professional with the population served until the individual meets one year of experience; or
- graduate of college or university with a bachelor’s degree in a human service field with less than two years of full-time post-bachelor’s degree mental health or substance abuse experience with the population served, or a substance abuse professional with less than two years post bachelor’s degree accumulated supervised experience in alcoholism and drug abuse counseling. Supervision shall be provided by a qualified professional with the population served until the individual meets two years of experience; or
- graduate of a college or university with a bachelor’s degree in a field other than human services with less than four years of full-time, post bachelor’s degree accumulated supervised experience in mental health or substance abuse with the population served. Supervision shall be provided by a qualified professional with the population served until the individual meets four years of experience; or
- registered nurse who is licensed to practice in the State of North Carolina by the North Carolina Board of Nursing with less than four years of full-time accumulated experience in mental health or substance abuse with the population served. Supervision shall be provided by a qualified professional with the population served until the individual meets four years of experience.



4.b.(9) Behavioral Health Rehabilitative Services (continued)

(d) Provider Qualifications for Staff Employed by Agencies Enrolled with Medicaid

(iii) Qualified Professional (QP)

“Qualified Professional” within the mental health and substance abuse system means:

- an individual who holds a license, provisional license, certificate, registration or permit issued by the governing board regulating a human service profession, except a registered nurse who is licensed to practice in the State of North Carolina by the North Carolina Board of Nursing, who also has four years of full-time accumulated experience in mh/sa with the population served; or
- a graduate of a college or university with a Masters degree in a human service field and one year of full-time, post-graduate degree experience with the population served or a substance abuse professional with one year of full-time, post-graduate degree accumulated supervised experience in alcoholism and drug abuse counseling; or
- a graduate of college or university with a bachelor’s degree in a human service field and two years of full-time, post-bachelor’s degree experience with the population served or a substance abuse professional who has two years full-time, post-bachelor’s degree accumulated supervised alcoholism and drug abuse counseling; or
- a graduate of a college or university with a bachelor’s degree in a field other than human services with four years of full-time, post-bachelors degree accumulated mh/sa experience with the population served.

This category includes Substance Abuse Professional, Certified Substance Abuse Counselors (CSAC), Certified Clinical Supervisor (CCS), Licensed Clinical Additions Specialist (LCAS) \*

The full descriptions of categories of providers are found in the North Carolina Administrative Code

Supervision is provided as described below:

Covered services are provided to recipients by agencies directly enrolled in the Medicaid program which employ qualified professionals, associate professional and paraprofessionals. Medically necessary services delivered by associate and paraprofessionals are delivered under the supervision and direction of the qualified professional. The qualified professional personally works with consumers to develop the person centered individualized treatment plan and meets with consumers periodically during the course of treatment to monitor the services being delivered and to review the need for continued services. The supervising qualified professional assumes professional responsibility for the services provided by associate and paraprofessionals and spends as much time as necessary directly supervising services to ensure that recipients are receiving services in a safe and efficient manner in accordance with accepted standards of practice. The terms of the qualified professional’s employment with the directly enrolled agency providing service ensures that the qualified professional is adequately supervising the associate and paraprofessionals. The agencies ensure that supervisory ratios are reasonable and ethical and provide adequate opportunity for the qualified professional to effectively supervise the associate and paraprofessional staff assigned. Documentation is kept to support the supervision provided to associate and paraprofessional staff in the delivery of medically necessary services.

4.b.(9) Rehabilitative Services for Behavioral Health of EPSDT Eligible

- (a) The agency assures that if there are providers involved whose payment is based on reasonable cost, the State will provide appropriate cost reimbursement methodologies. Services are reimbursed in accordance with Attachment 4.19-B.
- (b) Services may be provided by: Licensed or certified psychologists, licensed clinical social workers, certified clinical nurse specialists in psychiatric mental health advanced practice, nurse practitioners certified in psychiatric mental health advanced practice, licensed psychological associates, licensed professional counselors, licensed marriage and family therapists, certified/licensed clinical addictions specialists, and certified/licensed clinical supervisors, when Medicaid-eligible children are referred by the Community Care of North Carolina primary care physician, a Medicaid enrolled psychiatrist, or the area mental health program or local management entity. Prior approval shall be required for each psychiatric outpatient visit after the 16<sup>th</sup> visit each calendar year for recipients under age 21.

The first 16 visits are unmanaged visits. Unmanaged visits are defined as services that do not require prior approval by a utilization review vendor under the fee for service delivery system. For individuals under 21, Medicaid policy does require that the child or adolescent be referred for these services through the child's Community Care of North Carolina primary care physician, a Medicaid enrolled psychiatrist or the Local Management Entity (LME). The referral is not limited to the primary care physician but does include a choice of referral sources. The referral is requested by the practitioner offering services and is indicated on the request for reimbursement. The reason for the requirement for a referral for children and adolescents is to promote coordination of care including medical and behavioral health services when indicated for this population.

State Plan Under Title XIX of the Social Security Act  
Medical Assistance Program  
State: North Carolina

---

4.b.(9) Rehabilitative Services for Behavioral Health of EPSDT Eligible (*continued*)

(c) Services under this section are provided by licensed practitioners or programs/agencies for the mentally ill, developmentally disabled and substance abusers certified/licensed as clinical addiction specialists (LCAS) and clinical supervisors (CCS) meeting the program standards of the Commission on Mental Health, Developmental Disabilities and Substance Abuse Services; and who are directly enrolled with Medicaid. These services are available to categorically needy and medically needy recipients.

Services may be provided by:

Licensed or certified psychologists, licensed clinical social workers, licensed clinical social worker associates, certified clinical nurse specialists in psychiatric mental health advanced practice, nurse practitioners certified in psychiatric mental health advanced practice, licensed psychological associates, licensed professional counselors, licensed professional counselor associates, licensed marriage and family therapists, licensed marriage and family therapist associates, certified/licensed clinical addictions specialists, licensed clinical addictions specialist associates, and certified/licensed clinical supervisors.

For individuals under 21, the first 16 visits are unmanaged visits. Unmanaged visits are defined as services that do not require prior approval by a utilization review vendor under the fee for service delivery system. For individuals under 21, Medicaid policy does require that the child or adolescent be referred for these services through the child's Community Care of North Carolina primary care physician, a Medicaid enrolled psychiatrist or the Local Management Entity (LME). The referral is not limited to the primary care physician but does include a choice of referral sources. The referral is requested by the practitioner offering services and is indicated on the request for reimbursement. The reason for the requirement for a referral for children and adolescents is to promote coordination of care including medical and behavioral health services when indicated for this population.

For individuals 21 years and older, the first 8 visits are unmanaged visits. Unmanaged visits are defined as services that do not require prior approval by a utilization review vendor under the fee for service delivery system. Medicaid eligible adults (21 years and older) may be self-referred.

State Plan Under Title XIX of the Social Security Act  
Medical Assistance Program  
State: North Carolina

---

Services include the following:

1. Outpatient Psychotherapy services are individual psychotherapy, family psychotherapy; and group psychotherapy. Psychotherapy, as defined in the 2011 American Medical Association's Current Procedural Terminology (CPT) Manual, is the treatment for mental illness as well as substance use disorders in which the clinician through therapeutic communication attempts to alleviate the emotional disturbances and reverse or change maladaptive patterns of behavior. Individual psychotherapy is psychotherapy provided with the licensed clinician and the beneficiary on a one-to-one face-to-face basis. Family psychotherapy is psychotherapy provided with the licensed clinician and one or more family members face-to-face. Group psychotherapy is psychotherapy provided with the licensed clinician and more than one beneficiary face to face. Psychotherapy services may be provided in a variety of settings and psychotherapy may be practiced utilizing a variety of models many of which have significant evidence backing their efficacy. These models include Behavior Therapy, Cognitive Therapy, Psychodynamic Therapy, Cognitive Behavioral Therapy, and Person-Centered Therapy. Behavior Therapy is a treatment model that focuses on modifying. Observable behavior in order to regain and restore the beneficiary's level of social and emotional functioning and engagement in the community. Cognitive Therapy is a treatment model that focuses on challenging and changing distorted thinking in order to regain and restore the beneficiary's level of social and emotional functioning and engagement in the community. Psychodynamic Therapy is a treatment model that assumes dysfunctional behavior is caused by unconscious internal conflicts. The focus of treatment is to gain insight into unconscious motives of behavior in order to regain and restore the beneficiary's level of social and emotional functioning and engagement in the community. Cognitive Behavioral Therapy is a treatment model that assumes that maladaptive thinking patterns cause maladaptive behavior as well as negative emotions. The treatment focuses on changing the recipient's thoughts in order to change behavior as well as emotions in order to regain and restore the beneficiary's level of social and emotional functioning and engagement in the community.

---

TN No. 11-056  
Supersedes  
TN No. NEW

Approval Date:01-29-13

Effective Date: 01/01/2012

State Plan Under Title XIX of the Social Security Act  
Medical Assistance Program  
State: North Carolina

---

Person-Centered Therapy is a nondirective treatment model in which the clinician helps the beneficiary increase understanding and awareness of attitudes, feelings, and behavior, in order to regain and restore the beneficiary's level of social and emotional functioning and engagement in the community.

All psychotherapy services are only for the benefit of Medicaid recipients. These services can be furnished by all the North Carolina licensed and certified clinicians listed below. These North Carolina licensed and certified clinicians are: licensed psychologists, licensed clinical social workers, certified clinical nurse specialists in psychiatric mental health advanced practice, nurse practitioners certified in psychiatric mental health advanced practice, licensed physician assistants, licensed psychological associates, licensed professional counselors, licensed marriage and family therapists, licensed clinical addictions specialists, and certified clinical supervisors. Each of the above listed clinicians are licensed by their respective occupational licensing board and are credentialed to practice independently and it is within their scope of practice to provide individual psychotherapy, family psychotherapy, and group psychotherapy.

Psychological testing (e.g., Minnesota Multiphasic Personality Inventory, Rorschach, Wechsler Adult Intelligence Scale) includes written, visual, or verbal evaluations administered to assess the cognitive and emotional functioning of recipients. Developmental testing (e.g., Developmental Screening Test, Bayley Scales of Infant and Toddler Development, Mullen Scales of Early Learning) includes assessment of motor, language, social, adaptive and/or cognitive functioning by standardized developmental instruments. Neuro-behavioral testing (e.g., Halstead-Reitan, Wechsler Memory Scales, Wisconsin Card Sorting Test) includes standard tests designed to evaluate different aspects of the functioning of the central nervous system, including attention, motor performance, perceptual coding, learning, memory and affect. The SPA states on page 3.1-A.1, Page 15a.17: "These services can only be billed by PhD and Master's Level Psychologist, licensed in the State of NC."

---

TN No. 11-056  
Supersedes  
TN No. NEW

Approval Date: 01-29-13

Effective Date: 01/01/2012

State Plan Under Title XIX of the Social Security Act  
Medical Assistance Program  
State: North Carolina

---

These individuals have, within the scope of their practice, the ability to perform psychological testing, developmental testing, and neurobehavioral testing. However, each individual psychologist must also have the training and experience required in order to ethically provide each of these assessments according to the requirements of the North Carolina Psychology Board.

Psychological testing, developmental testing, and neuro-behavioral testing should result in recommendations regarding the need for rehabilitative treatment which may include outpatient services and should result in recommendations for type, duration, frequency, or amount of rehabilitative services.

- (d) All disciplines are licensed or credentialed by the State as mental health clinicians and can practice independently with oversight by their individual boards. Nurse Practitioners must have oversight by the Medical Board, while Licensed Psychological Associates must have supervision by a PhD to bill certain services. This type of requirement does not exist for the other disciplines. Certified/Licensed Clinical Supervisors (CCS) and Certified/Licensed Clinical Addictions Specialists (CCAS) requirements have been approved by the Division of Mental Health/Developmental Disabilities/Substance Abuse Services and are able to practice independently to provide counseling services only.
- (e) Behavioral assessment and counseling codes may be billed by all clinicians. CPT codes or counseling codes should be used to define services provided not based on discipline.

4.b.(9) Rehabilitative Services for Behavioral Health of EPSDT Eligible (continued)

---

(d) EPSDT Early Intervention Rehabilitative Services:

Medicaid-eligible children from birth to age three who are referred to and/or determined to be eligible for the NC Infant-Toddler Program under Part C of the Individuals with Disabilities Education Act (IDEA) are eligible for services through the Children's Developmental Service Agency (CDSA). The CDSA is the local lead agency for the NC Infant-Toddler Program.

Rehabilitative Services for Infants and Toddlers include a range of coordinated services provided to children from birth to age 3 in order to correct, reduce, or prevent further deterioration of identified deficits in the cognitive, communicative, physical, socioemotional, physical, or adaptive developmental status.

They can also be targeted at restoring the developmental capacity of children who are felt to be at risk for such deficits because of specific medical, biological, or environmental risk factors. Children under three must meet all eligibility for early intervention services delineated in the "North Carolina Infant and Toddler Manual."

Deficits are identified through comprehensive screening, assessments, and evaluations. Recommended services must be face-to-face encounters, medically necessary, within the scope of practice of the provider, and intended to maximize reduction of identified disability (ies) or deficit (s) and restoration of a recipient to his best possible functional level. Services include providing information related to the health and development of a child, skills training, modeling and offering anticipatory guidance to parents and to caregivers and assisting those in identifying, planning and maintaining a regimen related to regaining the child's functioning. Services may be provided in office settings, home, day care center, or other natural environment locations.

Provision of services to the family or caregivers must be directed to meeting the identified child's medical treatment needs. Services provided to non-Medicaid eligible family members independent of meeting the identified needs of the child are not covered by Medicaid. Services must be ordered by and under the direction of a Physician, Psychologist, Advanced Practice Nurse, or Physician's Assistant.

The following services are covered when medically necessary.

4.b.(9) Rehabilitative Services for Behavioral Health of EPSDT Eligible (continued)  
(d) EPSDT Early Intervention Rehabilitative Services

Services include:

Audiological: services to identify children with auditory impairment, using at risk criteria and appropriate audiologic evaluation procedures to determine the range, nature, and degree of hearing loss and communication functions. It includes referral for medical and other services necessary for the rehabilitation, provision of auditory training and aural rehabilitation, and determination of the child's need for amplification and its selection, use, and evaluation. These services must be provided by an Audiologist. As defined in 42 CFR 440.110, an Audiologist who has a valid license issued by the NC Board of Examiners for Speech and Language Pathologists and Audiologists.

Nutritional Assessment: services that include conducting nutritional assessments, developing and monitoring appropriate plans to address the nutritional needs of the child, based on the findings of the nutritional assessment, and making referrals to appropriate community resources to carry out nutritional goals. These services must be provided by a Nutritionist/Dietician registered with the American Dietetic Association's Commission on Dietetic Registration or licensed by the NC Board of Dietetics/Nutrition.

Occupational Therapy: services to address the functional needs of a child related to adaptive development, adaptive behavior and play, and sensory, motor, and postural development to improve the child's functional ability to perform tasks, including identification, assessment, intervention, adaptation of the environment, and selection of assistive and orthotic devices. These services must be provided by an Occupational Therapist as defined in 42 CFR 440.110 and be licensed pursuant to North Carolina State law or by a licensed Occupational Therapy Assistant under the supervision of a licensed Occupational Therapist.

Physical Therapy: services to address the promotion of sensor motor function through enhancement of musculoskeletal status, neurobehavioral organization, perceptual and motor development, cardiopulmonary status, and effective environmental adaptation. It includes evaluation to identify movement dysfunction, obtaining, interpreting and integrating information for program planning and treatment to prevent or compensate for functional problems. These services must be provided by a Physical Therapist as defined in 42 CFR 440.110 and be licensed pursuant to North Carolina State law or a licensed Physical Therapy Assistant under the supervision of a licensed Physical Therapist.



4.b.(9) Rehabilitative Services for Behavioral Health of EPSDT Eligible (continued)

(d) EPSDT Early Intervention Rehabilitative Services

Psychological: services are administering psychological and developmental tests, interpreting results, obtaining and integrating information about the child's behavior, child and family conditions related to learning, mental health and development, and planning and managing a program of psychological services, including psychological counseling, family counseling, consultation on child development, parent training and education programs. Qualifications of the practitioners who furnish psychological services are as follows: A Licensed Family and Marriage Counselor as defined in Article 18C of the Marital and Family Therapy Certification Act. A Licensed Clinical Social Worker (LCSW) or a Licensed Clinical Social Worker-Provisional (LCSW-P), under the supervision of an LCSW, in accordance with the Ethical Guidelines of the Social Worker Act (NCGS 90B) and the NASW Code of Ethics. A psychologist licensed by the NC Psychology Board, in accordance with the NC Psychology Act. A Licensed Professional Counselor (LPC) or a Licensed Professional Counselor Associate (LPCA), under the supervision of a LPC, in accordance with the Licensed Professional Counseling Act (NCGS 24).

Speech/Language: services to identify children with communicative or oropharyngeal disorders and delays in communication skills development, referral for medical or other professional services and the provision of services necessary for their rehabilitation. These services must be provided by a Speech Pathologist as defined in 42 CFR 440.110 and be licensed pursuant to North Carolina State law or, a Speech/Language Pathology Assistant who works under the supervision of an enrolled licensed Speech Pathologist. A Speech/Language Pathology Assistant (SLPA) must hold an Associate's degree in Speech/Language Pathology or a Bachelor's Degree from an accredited institution with specialized coursework in Speech/Language Pathology. A SLPA must also pass a competency test by the North Carolina Board of Examiners for Speech and Language Pathologists and Audiologists.

Clinical Social Work: services are evaluation of a child's living conditions and patterns or parent-child interaction, preparing a social or emotional assessment of the child within the family context, counseling parents and other family members, appropriate social skill-building with the child and parents, working with those problems in the child's living situation, and identifying community resources to enable the child and family to receive maximum benefit from services. These services may be provided by a Licensed Clinical Social Worker (LCSW) or a Licensed Clinical Social Worker-Provisional (LCSW-P) under the supervision of an LCSW, in accordance with the Ethical Guidelines of the Social Worker Act (NCGS 90B) and the NASW Code of Ethics.

Multidisciplinary Evaluations and Assessments: services are screening, evaluation, and assessment procedures used to determine a child's initial and continuing eligibility for Early Intervention services, the child's level of functioning in the developmental domains, and a medical perspective on the child's development.

4.b.(9) Rehabilitative Services for Behavioral Health of EPSDT Eligible (continued)  
(d) EPSDT Early Intervention Rehabilitative Services

This service is used to determine the child's strengths and needs, and services appropriate to meet those needs, as well as the resources and concerns of the family, and the supports and services necessary to enhance the family's capacity to meet their child's developmental needs. These services may be provided by a physician, a Pediatrician, or Physician's Assistant, in accordance with the scope of the NC Medical Practice Act, a Nurse Practitioner within the scope of the Nurse Practice Act ; a Registered Nurse licensed in the State of North Carolina, in accordance with the NC Board of Nursing; an Audiologist (described above) an Occupational Therapist (described above); a Physical Therapist (described above); a Nutritionist/Dietician (described above); a Psychologist (described above); a Speech Pathologist (described above); a Licensed Family and Marriage Counselor (described above); a Licensed Clinical Social Worker (LCSW) or a Licensed Clinical Social Worker-Provisional (LCSW-P) (described above); an Educational Diagnostician, with a master's degree in special education or related field, with at least six hours of coursework and two years of experience in educational/developmental testing, or a bachelor's degree in special education or related field, with at least six hours of coursework and three years of experience in educational/developmental testing. Examples of related fields include degrees in psychology or general education.

Community Based Rehabilitative Services: This service is provided to meet the cognitive, communication, social/emotional and adaptive development needs of the child.

The ITFS, in consultation with the IFSP team, will work with caregivers on planning and developing individualized intervention strategies for the child to extend opportunities to practice the following skills into everyday activities in the home, daycare or other community setting: thinking, problem solving and information processing skills, self-help skills, appropriate social behaviors and interactions, language skills, and gross and fine motor skills.

4.b.(9) Rehabilitative Services for Behavioral Health of EPSDT Eligible (continued)  
(d) EPSDT Early Intervention Rehabilitative Services

Providers of Community Based Rehabilitative Services are as follows: An individual with Infant, Toddler, and Family Specialist (ITFS) certification or a Infant, Toddler, and Family Associate (IFSA) working toward certification at the required rate. The ITFS must hold a Bachelor's degree or higher in a health, education, early childhood, or human service field or hold a Bachelor's degree or higher in a non-human service field but have four years of full-time, post-Bachelor's degree accumulated experience with the infant and toddler population, or are a Registered Nurse and hold a current North Carolina license. The IFSA must hold an Associate's degree or less in a health, education, early childhood, or other human service field. Both ITFS and IFSA must have at least 27 hours of coursework in health, education, or early childhood. The North Carolina Division of Public Health, through the Children's Developmental Services Agencies (CDSAs), documents and verifies the qualifications, training, and certification of the ITFS, verifies the valid licensure status (if applicable), and recommends the provider for Medicaid participation.

Services performed by the Infant, Toddler, and Family certified individual must be ordered by the physician, Psychologist, advanced practice nurse, or physician's assistant.

(8) Medicaid Services Provided in Schools

(a) Audiology

Services must be medically necessary and appear in the child's Individualized Education Plan. Covered services include:

Assessment services:

Service may include testing and/or clinical observation as appropriate for chronological or developmental age for one or more of the following areas of functioning, and shall yield a written report:

Auditory sensitivity, including pure tone air and bone conduction, speech detection, and speech reception thresholds, auditory discrimination in quiet and noise, impedance audiometry including tympanometry and acoustic reflex, hearing aid evaluation, central auditory function and auditory brainstem evoked response

Treatment services:

Service may include one or more of the following as appropriate:

Auditory training, speech reading and augmentative communication

Qualifications of Providers: Providers must meet the applicable requirements of 42 CFR 440.110. A provider shall have a valid license issued by the Board of Examiners for Speech and Language Pathologists and Audiologists.

(b) Occupational Therapy

Services must be medically necessary and appear in the child's Individualized Education Plan. Covered services include:

Assessment services

Service may include testing and/or clinical observation as appropriate for chronological or developmental age for one or more of the following areas of functioning, and shall yield a written report:

Activities of daily living assessment, sensorimotor assessment, neuromuscular assessment, fine motor assessment, feeding/oral motor assessment, visual perceptual assessment, perceptual motor development assessment, musculo-skeletal assessment, gross motor assessment, and functional mobility assessment.

Treatment services

Service may include one or more of the following as appropriate:

Activities of daily living training, sensory integration, neuromuscular development, muscle strengthening, and endurance training, feeding/oral motor training, adaptive equipment application, visual perceptual training, facilitation of gross motor skills, facilitation of fine motor skills, fabrication and application of splinting and orthotic.

devices, manual therapy techniques, sensorimotor training, functional mobility training, perceptual motor training.

Qualifications of Providers:

Providers must meet the applicable requirements of 42 CFR 440.110. Occupational therapy assessment services must be provided by a licensed occupational therapist. Occupational therapy treatment services must be provided by a licensed occupational or a licensed occupational therapist assistant under the supervision of a licensed occupational therapist.

(c) Physical Therapy Services

Services must be medically necessary and appear in the child's Individualized Education Plan. Covered services include:

Assessment services

Service may include testing and/or clinical observation as appropriate for chronological or developmental age for one or more of the following areas of functioning, and shall yield a written report:

Neuromotor assessment, range of motion, joint integrity and functional mobility, flexibility assessment, gait, balance, and coordination assessment, posture and body mechanics assessment, soft tissue assessment, pain assessment, cranial nerve assessment, clinical electromyographic assessment, nerve conduction, latency and velocity assessment, manual muscle test, activities of daily living assessment, cardiac assessment, pulmonary assessment, sensory motor assessment and feeding/oral motor assessment

Treatment services

Service may include one or more of the following as appropriate:

Manual therapy techniques, fabrication and application of orthotic devices, therapeutic exercise, functional training, facilitation of motor milestones, sensory motor training, cardiac training, pulmonary enhancement, adaptive equipment application, feeding/oral motor training, activities of daily living training, gait training, posture and body mechanics training, muscle strengthening, gross motor development, modalities, therapeutic procedures, hydrotherapy, manual manipulation

Qualifications of Providers:

Providers must meet the applicable requirements of 42 CFR 440.110. Physical therapy assessment services must be provided by a licensed physical therapist. Physical therapy treatment services must be provided by a licensed physical therapist or a licensed physical therapist assistant under the supervision of a licensed physical therapist.

(d) Psychological Services

Services must be medically necessary and appear in the child's Individualized Education Plan. Covered services include:

Assessment services

Service may include testing and/or clinical observation as appropriate for chronological or developmental age for one or more of the following areas of functioning, and shall yield a written report:

Cognitive, emotional/personality, adaptive behavior, behavior and perceptual or visual motor.

Treatment services

Service may include one or more of the following as appropriate:

Cognitive-behavioral therapy, rational-emotive therapy, family therapy, individual interactive psychotherapy using play equipment, physical devices, language interpreter or other mechanisms of non verbal communication and sensory integrative therapy

Qualifications of Providers:

Minimum qualifications for providing services are licensure as a psychological associate or practicing psychologist by the North Carolina State Board of Examiners of Practicing Psychologists, or licensure as a school psychologist by the NC Department of Public Instruction, and Licensed Clinical Social Workers. Licensed Clinical Social Workers and Licensed Psychologists must be able to provide documentation of appropriate training and experience, which qualified them to work with students in an educational setting.

(e) Speech

Services must be medically necessary and appear in the child's Individualized Education Plan. Covered services include:

Assessment services

Service may include testing and/or clinical observation as appropriate for chronological or developmental age for all the following areas of functioning and shall yield a written report: Receptive and expressive language, auditory memory, discrimination, and processing, vocal quality and resonance patterns, phonological development, pragmatic language, rhythm/fluency, oral mechanism, swallowing assessment, augmentative communication and hearing status based on pass/fail criteria

Treatment services

Service includes one or more of the following as appropriate:

Articulation therapy, language therapy; receptive and expressive language, augmentative communication training, auditory processing, discrimination, and training, fluency training, disorders of speech flow, voice therapy, oral motor training; swallowing therapy and speech reading.

Qualifications of Providers: Providers must meet the applicable requirements of 42 CFR 440.110. Clinicians must have the following credentials:

1. a valid license issued by the Board of Examiners for Speech and Language Pathologists and Audiologists, and
2. a Certificate of Clinical Competence (CCC) from the American Speech and Hearing Association;
  - A. have completed the equivalent educational requirements and work experience necessary for the CCC, or
  - B. have completed the academic program and is acquiring the supervised work experience to qualify for the CCC.

Treatment services may be performed by a Speech/Language Pathology assistant who works under the supervision of an enrolled licensed practitioner. A provider shall perform services within the scope of practice of speech pathology as defined by G.S. 90-293 as interpreted by the courts.

(f) Nursing Services:

Services must be medically necessary. The services must be provided in accordance with an Individualized Education Program or an Individual Family Service Plan. Nursing services must be those services that are in a written plan of care based on a physician, physician assistant or nurse practitioner's written order. The plan of care must be developed by a licensed registered nurse. Services include: assessments including referrals based on results, bladder catheterizations, suctioning, medication administration and management including observation for adverse reactions, response or lack of response to medication, informing the student about their medications, oxygen administration via tracheostomy and ventilator care, enteral feedings, emergency interventions, individual health counseling and instructions, and other treatments ordered by the physician and outlined in the plan of care.

Qualifications of Providers:

The Licensed Practical Nurse and Registered Nurse shall be licensed by the State of North Carolina to provide the services and practice within the NC Nursing Practice Act. Nursing services can be provided under 42 CFR 440.60 and on a restorative basis under 42 CFR 440.130 (d) including services delegated in accordance with the Nurse Practice Act to individuals trained to perform delegated acts by a Registered Nurse. Delegated staffs are school and contracted staff such as teachers, teacher assistants, therapists, school administrators, administrative staff, cafeteria staff and personal care aides.

- (9) Medicaid-eligible children from birth to age three who are referred to and/or determined to be eligible for the NC Infant-Toddler Program under Part C of the Individuals with Disabilities Education Act (IDEA) are eligible for services through the Children's Developmental Service Agency (CDSA). The CDSA is the local lead agency for the NC Infant-Toddler Program. At the request of the IDEA (LEA), the CDSA may perform evaluations on Preschoolers (age 3, 4 and 5). For children who are transitioning from the NC Infant-Toddler Program to Preschool services, eligibility may extend beyond the third birthday as long as there is a time-limited transition plan in place.

The following federally mandated services are provided under the IDEA, covered when medically necessary and the service is outlined in the child's Individual Family Service Plan (IFSP).

- (a) Services include:

Audiological: services to identify children with auditory impairment, using at risk criteria and appropriate audiologic evaluation procedures to determine the range, nature, and degree of hearing loss and communication functions. It includes referral for medical and other services necessary for the rehabilitation, provision of auditory training and aural rehabilitation, and determination of the child's need for amplification and its selection, use, and evaluation.

Nutrition: services that include conducting nutritional assessments, developing and monitoring appropriate plans to address the nutritional needs of the child, based on the findings of the nutritional assessment, and making referrals to appropriate community resources to carry out nutritional goals.

Occupational Therapy: services to address the functional needs of a child related to adaptive development, adaptive behavior and play, and sensory, motor, and postural development to improve the child's functional ability to perform tasks, including identification, assessment, intervention, adaptation of the environment, and selection of assistive and orthotic devices.

Physical Therapy: services to address the promotion of sensorimotor function through enhancement of musculoskeletal status, neurobehavioral organization, perceptual and motor development, cardiopulmonary status, and effective environmental adaptation. It includes evaluation to identify movement dysfunction, obtaining, interpreting and integrating information for program planning and treatment to prevent or compensate for functional problems.



**State Plan Under Title XIX of the Social Security Act**  
**Medial Assistance Program**  
**State: NORTH CAROLINA**

---

**PAGE INTENTIONALLY LEFT BLANK**

TN No. 10-008  
Supersedes  
TN No. 03-003

Approval Date 05-16-11

Eff. Date 07/01/2010

**State Plan Under Title XIX of the Social Security Act**  
**Medial Assistance Program**  
**State: NORTH CAROLINA**

---

**PAGE INTENTIONALLY LEFT BLANK**

TN No. 10-008  
Supersedes  
TN No. 03-003

Approval Date 05-16-11

Eff. Date 07/01/2010

**State Plan Under Title XIX of the Social Security Act**  
**Medial Assistance Program**  
**State: NORTH CAROLINA**

=====

**PAGE INTENTIONALLY LEFT BLANK**

TN No. 10-008  
Supersedes  
TN No. 03-003

Approval Date 05-16-11

Eff. Date 07/01/2010

**State Plan Under Title XIX of the Social Security Act**  
**Medial Assistance Program**  
**State: NORTH CAROLINA**

---

**PAGE INTENTIONALLY LEFT BLANK**

TN No. 10-008  
Supersedes  
TN No. 03-003

Approval Date 05-16-11

Eff. Date 07/01/2010

**State Plan Under Title XIX of the Social Security Act**  
**Medial Assistance Program**  
**State: NORTH CAROLINA**

=====

**PAGE INTENTIONALLY LEFT BLANK**

TN No. 10-008  
Supersedes  
TN No. 03-003

Approval Date 05-16-11

Eff. Date 07/01/2010

**State Plan Under Title XIX of the Social Security Act**  
**Medial Assistance Program**  
**State: NORTH CAROLINA**

---

**PAGE INTENTIONALLY LEFT BLANK**

TN No. 10-008  
Supersedes  
TN No. 03-003

Approval Date 05-16-11

Eff. Date 07/01/2010

**State Plan Under Title XIX of the Social Security Act**  
**Medial Assistance Program**  
**State: NORTH CAROLINA**

---

**PAGE INTENTIONALLY LEFT BLANK**

TN No. 10-008  
Supersedes  
TN No. 03-003

Approval Date 05-16-11

Eff. Date 07/01/2010

4.b(10) Dietary Evaluation and Counseling

Dietary evaluation and counseling are provided by a qualified nutritionist to Medicaid eligible children through age 20 identified as having high risk conditions by their health care provider, include but are not limited to:

- Nutrition assessment
- Development of an individualized care plan
- Diet therapy
- Counseling, education about needed nutrition habits/skills and follow-up

The high risk indicators used to assess the medical need for services for children through age 20 are as follows:

1. there is a chronic, episodic, or acute condition for which nutrition therapy is a critical component of medical management, including but not limited to:
  - a. inappropriate growth/weight gain such as inadequate weight gain, inappropriate weight loss, underweight, obesity, inadequate linear growth, or short stature
  - b. nutritional anemia
  - c. eating or feeding disorders that result in a medical condition such as failure to thrive, anorexia nervosa, or bulimia nervosa
  - d. physical conditions that impact growth and feeding such as very low birth weight, necrotizing enterocolitis, cleft palate, cerebral palsy, and neural tube defects
  - e. chronic or prolonged infections that have a nutritional treatment component such as HIV or hepatitis
  - f. genetic conditions that affect growth and feeding such as cystic fibrosis, Prader-Willi Syndrome, or Down Syndrome
  - g. chronic medical conditions such as cancer, chronic or congenital cardiac disease, hypertension, hyperlipidemia, gastrointestinal diseases, liver disease, pulmonary disease, malabsorption syndromes, renal disease, significant food allergies, and diseases of the immune system
  - h. metabolic disorders such as inborn errors of metabolism (PKU, galactosemia, etc.) and endocrine disorders (diabetes, etc.)
  - i. Non-healing wounds due to chronic conditions
  - j. Acute burns over significant body surface area
  - k. Metabolic Syndrome/Type 2 diabetes
  - l. a documented history of a relative of the first degree with cardiovascular disease and/or possessing factors that significantly increase the risk of cardiovascular disease such as a sedentary lifestyle, elevated cholesterol, smoking, high blood pressure, greater than ideal body weight.
2. There is a preventable condition for which nutrition/diet is the primary therapy.

Provider Qualifications

Medicaid enrolled providers who employ licensed dietitians/nutritionists or registered dietitians are eligible to provide dietary evaluation and counseling. It is the responsibility of the provider agency to verify in writing that staff meet the following qualifications:

1. a dietitian/nutritionist, currently licensed by the N.C. Board of Dietetics/Nutrition (provisional license is not acceptable)
2. a registered dietitian, currently registered with the Commission of Dietetic Registration (registration eligibility is not acceptable).



5. Physicians' Services

All medical services performed must be medically necessary and may not be experimental in nature. Medical necessity is determined by generally accepted North Carolina community practice standards as verified by independent Medicaid consultants.

- a. Routine physician examinations and screening tests are covered for adults and EPSDT recipients, which include adults and children in nursing facilities.
- b. Experimental – Medical care that is investigatory or an unproven procedure or treatment regimen that does not meet generally accepted standards of medical practice in North Carolina.

In evaluating whether a particular service is or is not experimental the agency will consider safety, effectiveness and common acceptance as verified through 1) scientifically validated clinical studies 2) medical literature research and 3) qualified medical experts.

- d. Injections are excluded when oral drugs may be used in lieu of injections.
- e. Therapeutic abortions are covered only in the case where a woman suffers from a physical disorder, physical injury, or physical illness, including a life-endangering physical condition caused by or arising from the pregnancy itself, that would, as certified by physician, place the woman in danger of death unless an abortion is performed; therapeutic abortions are also covered in cases of rape or incest.

TN No.: 11-049  
Supersedes  
TN No.: 06-014

Approval Date: 12-16-11

Effective Date: 10/01/2011

Optional Services 42 CFR 440.225 (Continued)

---

Optional Services Limitation:

Combined optional services are limited to eight per recipient per State fiscal year. This limitation does not apply to EPSDT eligible children. Exceptions to the limit may be authorized by the State when additional visits are medically necessary.

6.a. Podiatrists' Services

- (1) Routine foot care is not covered except as a medical necessity.
- (2) Office visits to podiatrists are included in the optional services limit per recipient per State fiscal year.

TN No.: 06-014  
Supersedes  
TN No.: NEW

Approval Date: 07/10/07

Effective Date: 10/01/06

6.b. Optometrists' Services

(1) Routine eye exams and refractions are only covered for recipients under 21 years of age and are limited to once per year based on general medical practice as published in North Carolina Division of Medical Assistance's Medicaid clinical coverage policies on the Division's website at <http://www.dhhs.state.nc.us/dma/mp/mpindex.htm>. Additional eye refractions may be authorized by the State Medicaid Agency, based on medical necessity.

TN No.: 11-049  
Supersedes  
TN No.: 06-014

Approval Date: 12/16/11

Effective Date: 10/01/2011

Optional Services 42 CFR 440.225 (Continued)

---

6.c. Chiropractors' Services

- (1) Chiropractic services are limited to manual manipulation of the spine to correct subluxation which has resulted in a neuromusculoskeletal condition for which manipulation is appropriate. X-rays are covered as part of the documentation associated with the definition of the musculoskeletal condition for which manual manipulation of the spine is appropriate. When an x-ray is used as part of the documentation of need for the services the x-ray must be taken within six months of the date of service.
- (2) Chiropractic services include only services provided by a chiropractor who is licensed by the State.
- (3) Chiropractic providers must meet the educational requirements as outlined in 42 CFR 410.21.
- (4) Office visits to chiropractors are included in the optional services limit per recipient per State fiscal year.

---

TN No: 07-003  
Supersedes  
TN No: 06-014

Approval Date: 11/24/08

Effective Date: 01/01/07

Optional Services 42 CFR 440.225 (*Continued*)

---

6.d. Other practitioners' services

- (1) Limitations for nursing practitioner services are on Page 12a of Attachment 3.1-A.1.
- (2) Licensed psychologists, licensed clinical social workers, licensed nurse practitioners, certified in child and adolescent psychiatry and licensed clinical nurse specialists certified in child and adolescent psychiatry can provide psychotherapeutic assessment and treatment services to EPSDT eligible children with a referral from the Carolina ACCESS primary care provider or the area Local Management Entity (LME). Prior approval shall be required for each psychiatric hospital outpatient visit after the 16<sup>th</sup> visit for recipients under age 21.
- (3) Physician Assistants:

Coverage Limitations for Physician Assistants:

Medical services must be performed in accordance with the physician assistant scope of practice determined by the State of North Carolina.

6.d. I. Other Practitioners' Services

A. Criteria For Medicaid Coverage Of Nurse Practitioner Services

Nurse practitioner services means that the services are:

- 1) provided in accordance with the scope of practice as defined by the State Board of Medical Examiners and Board of Nursing;
- 2) performed by nurse practitioners who are duly licensed to practice nursing and are approved by the State Board of Medical Examiners and Board of Nursing as “nurse practitioners”; and
- 3) performed under the supervision of a physician licensed in the State of practice.

B. Coverage Limitations For Nurse Practitioner Services

Medical services must be performed in accordance with the nurse practitioners scope of practice and signed protocols, as follows:

- 1) By Nurse Practitioners in an independent practice (i.e. not in the employ of a practitioner, clinic or other service provider for the provision of Nurse Practitioner services).
- 2) For DMA approved procedures developed for use by Nurse Practitioners.
- 3) Subject to the same coverage limitations as those in effect for Physicians.

6.d. I. Other Practitioners' Services (continued)

- C. For Medicaid eligible adults, services may be provided by licensed psychologists, licensed clinical social workers, clinical nurse specialists (psychiatric mental health advanced practice), and nurse practitioners (psychiatric mental health advanced practice), licensed psychological associates, licensed professional counselors, and licensed marriage and family therapists. Medicaid eligible adults may be self referred. Prior approvals shall be required for each psychiatric outpatient visit after the eighth visit for recipients age 21 years and over.

TN No. 04-011  
Supersedes  
TN No. New

Approval Date: 07/13/05

Effective Date: 01/01/05



THIS PAGE INTENTIONALLY LEFT BLANK

TN No.: 10-032  
Supersedes  
TN No.: 06-007B

Approval Date: 05/24/11

Effective Date: 11/01/10

**THIS PAGE INTENTIONALLY LEFT BLANK**

TN No.: 10-032  
Supersedes  
TN No.: 06-007B

Approval Date: 05/24/11

Effective Date: 11/01/10

THIS PAGE INTENTIONALLY LEFT BLANK

TN No.: 10-032  
Supersedes  
TN No.: 06-007B

Approval Date: 05/24/11

Effective Date: 11/01/10

**THIS PAGE INTENTIONALLY LEFT BLANK**

TN No.: 10-032  
Supersedes  
TN No.: 06-007B

Approval Date: 05/24/11

Effective Date: 11/01/10

*Intentionally Left Blank*

7. Home Health

Home health services are provided by Medicare certified Home Health Agencies under a plan of care authorized by the patient's physician and in accordance with 42 CFR 440.70. Covered home health services include nursing services, services of home health aides, specialized therapies (speech therapy, physical therapy, occupational therapy) and medical supplies.

- a. Intermittent or Part-Time Nursing Services Furnished by a Medicare certified Home Health Agency.
  - (1) Care which is furnished only to assist the patient in meeting personal care needs is not covered.
  - (2) Intermittent or part-time nursing service by a registered nurse when no home health agency exists in the area is limited to a registered nurse employed by or under contractual arrangement with a local health department.

7. Home Health (*continued*)

b. Home Health Aide Services

The home health aide provides assistance to maintain health and to facilitate treatment of the illness or injury, under the supervision of a registered nurse and in accordance with 42 CFR 440.70.

A terminally ill beneficiary who elects hospice care waives Medicaid coverage of services by a home health aide under home health services.

7. Home Health (continued)

c. Medical supplies, equipment, and appliances suitable for use in the home.

1) Medical Supplies

Medical supplies are covered when medically necessary and suitable for use in the home in accordance with 42 CFR 440.70(a)(3). Medical supplies must be prescribed by a practitioner licensed according to North Carolina General Statute Chapter 90 under approved plan of care. These items will be covered when furnished by a Medicare Certified Home Health Agency, or by one of the following: an ME supplier; a PDN provider when providing PDN services (for supplies needed by a Division of Medical Assistance approved PDN patient) or by the PDN provider for medically necessary incontinent, ostomy and urological supplies (when no home health provider is available); a local lead agency for the Community Alternatives Program (CAP) for adults with disabilities and persons with mental retardation or developmental disabilities; or a local lead agency that provides case management for the Community Alternative Program for children. The “local lead agency” is the agency/facility in the county or counties that coordinates and manages the CAP program.



7. Home Health (*continued*)

c. Medical supplies, equipment, and appliances suitable for use in the home.

2) Medical Equipment

Medically necessary medical equipment (ME) is covered by the Medicaid program when prescribed by a licensed healthcare practitioner and supplied by a qualified ME provider in accordance with 42 CFR 440.70(c)(3). Prior approval must be obtained from the Division of Medical Assistance, or its designated agent.

To be a qualified provider, an entity must possess a state business license and a Board of Pharmacy permit, and be certified to participate in Medicare as a ME supplier, or be a Medicaid enrolled home health agency, a state agency, a local health department, a local lead agency for the Community Alternatives Program (CAP) for adults with disabilities and persons with mental retardation or developmental disabilities, or a local lead agency that provides case management for the Community Alternative Program for children.

The “local lead agency” is the agency/facility in the county or counties that coordinates and manages the CAP program.

Payment for medical equipment is limited to the official, approved ME list established by the Division of Medical Assistance. Additions, deletions or revisions to the ME list are approved by the Director of the Division of Medical Assistance upon recommendation of DMA staff. Only items determined to be medically necessary, effective and efficient are covered.

7. Home Health (*continued*)

c. Medical supplies, equipment, and appliances suitable for use in the home.

3) Home Infusion Therapy

Self-administered Home Infusion Therapy (HIT) is covered when it is medically necessary and provided through a Medicaid enrolled HIT agency as prescribed by a physician. "Self-administered" means that the patient and/or an unpaid primary caregiver is capable, able, and willing to administer the therapy following teaching and with monitoring. An agency must be a home care agency licensed in North Carolina for the provision of infusion nursing services to qualify for enrollment as a Home Infusion Therapy Provider.

The following therapies are included in this coverage when self-administered:

- i. Total parenteral nutrition
- ii. Enteral nutrition
- iii. Intravenous chemotherapy
- iv. Intravenous antibiotic therapy
- v. Pain management therapy, including subcutaneous, epidural, intrathecal, and intravenous pain management therapy

7. Home Health (*continued*)

- d. Specialized Therapies provided by a Medicare Certified Home Agency.
  - 1) Speech therapy, physical therapy and occupational therapy when ordered by the physician as a medically necessary part of the patient's care.
  - 2) Services are provided within accepted national standards and best practice guidelines for each type of therapy. Qualifications for therapy staff are in accordance with those outlined in 42 CFR 440.110.
  - 3) Services are provided only in the patient's home.

8. Private Duty Nursing Services

Medically necessary private duty nursing (PDN) services are provided under the direction of the recipient's physician in accordance with 42 CFR 440.80 and prior approval by the Division of Medical Assistance, or its designee.

Residents who are in adult care homes are not eligible for this service. This exclusion does not violate comparability requirements as adult care home residents do not have the medical necessity for continuous nursing care. According to State regulations for adult care homes, people are not to be admitted for professional nursing care under continuous medical supervision and residents who develop a need for such care are to be placed elsewhere. In addition, recipients in hospitals, nursing facilities, intermediate care facilities for the mentally retarded, rehabilitation centers, and other institutional settings are not eligible for this service. PDN services are not covered while an individual is being observed or treated in a hospital emergency room or similar environment.

This service is only approvable based on the need for PDN services in the patient's private residence. An individual with a medical condition that necessitates this service normally is unable to leave the home without being accompanied by a licensed nurse and leaving the home requires considerable and taxing effort. An individual may utilize the approved hours of coverage outside of his/her residence during those hours when the individual's normal life activities take the patient out of the home. The need for nursing care to participate in activities outside of the home is not a basis for authorizing PDN services or expanding the hours needed for PDN services.

Medicaid will not reimburse for Personal Care Services, Skilled Nursing Visits, or Home Health Aide Services provided during the same hours of the day as PDN services.

Medicaid Payments for PDN are made only to agencies enrolled with the Division of Medical Assistance as providers for the service. An enrolled provider must be a State licensed home care agency within North Carolina that is approved in its license to provide nursing services within the State. PDN services shall be rendered by a licensed registered nurse (RN) or licensed practical nurse (LPN) who is licensed by the North Carolina Board of Nursing and employed by a licensed home care agency.

A member of the patient's immediate family (spouse, child, parent, grandparent, grandchild, or sibling, including corresponding step and in-law relationship) or a legally responsible person who maintains their primary residence with the recipient may not be employed by the provider agency to provide PDN services reimbursed by Medicaid.

Mandatory Services 42 CFR 440.230

---

Mandatory services visits are provided in accordance with 42 CFR 440.230 per recipient per State fiscal year. Exceptions to a visit limitation may be authorized by the State when additional visits are medically necessary. The mandatory services visit limit is 22. This limitation does not apply to EPSDT eligible children.

9. Clinic Services

All medical services performed must be medically necessary and may not be experimental in nature.

- a. Only services furnished by or under the direction of a physician or dentist are covered.
- b. Clinic services for which physicians or dentists file directly for payment are not covered.
- c. Services specifically covered under other Medicaid programs, e.g., Family Planning or EPSDT, are not reimbursable under the clinic program.
- d. Office visits in a clinic setting are included in the visit limit per recipient per State fiscal year. This limitation does not apply to adults 21 and over receiving mental health services subject to independent utilization review.

TN No. 09-027  
Supersedes  
TN No. 90-26

Approval Date: 02-12-10

Eff. Date 10/01/09

e. End-Stage Renal Disease (ESRD) Facility Services

The following End-Stage Renal Disease services are covered:

- (1) Maintenance hemodialysis and peritoneal dialysis treatments are covered when they are provided by a Medicaid enrolled ESRD hospital-based renal dialysis center or free-standing ESRD facility.
  - a. Hemodialysis is defined as the removal of certain elements from the blood by virtue of the difference in the rates of their diffusion through a semi-permeable membrane while the blood is being circulated outside the body. Three sessions per week are generally provided.
  - b. Peritoneal dialysis is defined as a process by which waste products and excess fluids are removed from the blood when the body's own kidneys have failed. But unlike hemodialysis where the blood passes through a machine, peritoneal dialysis is done inside the body. Two types of peritoneal dialysis are covered:
    - (i) Continuous cycling peritoneal dialysis (CCPD), is a continuous dialysis process which uses a machine to make automatic exchanges at night.
    - (ii) Continuous ambulatory peritoneal dialysis (CAPD), which does not require a machine. CAPD is a continuous dialysis process that uses the patient's peritoneal membrane as a dialyzer. CCPD and CAPD are furnished on a continuous basis, not in discrete sessions.
- (2) Training in peritoneal self-dialysis for beneficiaries and individuals who will assist a beneficiary in peritoneal self-dialysis is covered.

Provider Qualifications

A dialysis center or free-standing facility must provide a letter of Certification as a Medicare provider from the Centers for Medicare and Medicaid Services (CMS).

10. Dental Services

All dental services performed must be medically necessary and may not be experimental in nature. Medical necessity is determined by generally accepted North Carolina community practice standards as verified by independent Medicaid consultants.

- a. Routine dental examinations and screening tests are covered for adults and EPSDT recipients, which include adults and children in nursing facilities.
- b. Experimental – Dental care that is investigatory or an unproven procedure or treatment regimen that does not meet generally accepted standards of medical practice in North Carolina.

In evaluating whether a particular service is or is not experimental the agency will consider safety, effectiveness and common acceptance as verified through 1) scientifically validated clinical studies 2) dental literature research and 3) qualified dental experts.

- c. The services requiring prior approval are: complete dentures, partial dentures, complete and partial denture relines, orthodontic services, periodontal services, elective root canal therapy, and complex or extensive oral maxillo-facial surgical procedures. Emergency services are exempt from prior approval. The Division of Medical Assistance will have the responsibility of prior authorization of dental services.
- d. Endodontic treatment is covered for anterior teeth only.
- e. Experimental appliances are non-covered services.
- f. Payment for full mouth x-ray series is allowed only once every five (5) years.
- g. Replacement of complete dentures may be made once every ten years. Replacement of partial dentures may be made once every eight years. Replacement after the expiration of fewer than ten years for complete dentures and after fewer than eight years for partial dentures may be made with prior approval if failure to replace the dentures will cause an extreme medical problem or irreparable harm. Initial reline of dentures may only be made if six months have elapsed since receipt of dentures. For an immediate denture, the initial reline may be approved and rendered earlier than six months from denture delivery if the provider determines that healing of extraction sites is essentially complete and a reline is necessary to ensure proper fit and function of the denture. Subsequent relines are allowed only at five year intervals; if failure to reline in fewer than five years will cause an extreme medical problem or irreparable harm, relines may be made with prior approval. Standard procedures and materials shall be used for full and partial dentures.
- h. The state assures that EPSDT eligible clients have access to 1905(A) services not specifically listed in the state plan when they are medically necessary.

12.a. Prescribed Drugs

- (1) Limited to rebateable legend drugs, Insulin and selected rebateable over the counter (OTC) drugs designated per the North Carolina Division of Medical Assistance policy on Over the Counter Medications, criteria listed in General Clinical Coverage Policy No. A2. Prior authorization is required for certain high-cost drugs which are subject to overutilization or abuse per the North Carolina Division of Medical Assistance Policy for Prior Authorization, General Clinical Coverage Policy No. A3.
- (2) For Non MAC (Maximum Allowable Cost) drugs, a prescription designated by a brand or trade name for which one or more equivalent drugs are available shall be considered to be an order for the drug by its generic name, except when the prescriber personally indicates in their own handwriting on the prescription order brand name "medically necessary". For MAC drugs, the prescriber must write in their own handwriting on the face of the prescription brand name "medically necessary". The Department may prevent substitution of a generic equivalent drug when the net cost to the State of the brand-name drug, after consideration of all rebates, is less than the cost of the generic equivalent. The Department will ensure that the preferred brand-name name drug is not on the Federal Upper Limit or State Maximum Allowable Cost lists in order to maintain lesser of logic pricing of prescription drug claims.



12. a. Prescribed Drugs *continued*

- (3) The Department may establish authorizations, limitations, and reviews for specific drugs, drug classes, brands, or quantities in order to manage effectively the Medicaid pharmacy program. This may include limitations on monthly brand-name and generic prescriptions as well as restrictions on the total number of medications, except that the Department may not impose limitations on brand-name medications for which there is a generic equivalent in cases where the prescriber has determined at the time the drug is prescribed, that the brand-name drug is medically necessary and has written on the prescription order the phrase "medically necessary". The Department may impose prior authorization requirements on brand-name drugs for which the phrase "medically necessary" is written on the prescription.
- (4) Drugs for which Medical Assistance reimbursement is available are limited to the following:

Covered outpatient drugs of any manufacturer which has entered into and complies with an agreement under Section 1927(a) of the Act which are prescribed for a medically accepted indication.

A preferred drug list or other restrictions such as Prior Authorization (PA) must permit coverage of participating manufacturers' drugs. In addition, prior authorization must be obtained from the Medicaid agency or its authorized agent for any drug on the prior authorization list before Medicaid reimbursement is available. The state provides for response by telephone or other telecommunication device within twenty-four (24) hours of a request for prior authorization. The state also provides for the dispensing of at least a seventy-two (72) hour supply of a covered outpatient prescription drug in an emergency situation (effective July 1, 1991).

12.a. Prescribed Drugs (continued)

Effective January 1, 1991 Medicaid will cover only drugs of participating manufacturers except 1-A drugs, where State process for approval must be described. (Because of extenuating circumstances waiver, the State may cover non-participating manufacturers' drugs for claims with date of service through March 31, 1991.)

The state will comply with the reporting requirements for State utilization information and on restrictions to coverage.

If the state has "existing" agreements, these will operate in conformance with law, and for new agreements, require CMS approval. The State must also agree to report rebates from separate agreements.

The State must allow manufacturer to audit utilization data.

The unit rebate amount is confidential and cannot be disclosed for purposes other than rebate invoicing and verification.

TN No.: 06-007A  
Supersedes  
TN. No.: NEW

Approval Date: 09/27/06

Effective Date: 06/01/06

State Plan Under Title XIX of the Social Security Act  
Medical Assistance Program  
State: NORTH CAROLINA

---

12.a. Prescribed Drugs (continued)

- (4) DESI drugs and any identical, similar or related products or combinations of these products are not covered.
- (5) Supplemental Medicaid Drug Rebate Agreements

A rebate agreement between the State and a drug manufacturer for drugs provided to the Medicaid population, submitted to CMS on December 30, 2009 and entitled, "State of North Carolina Magellan Medicaid Administration\_National Medicaid Pooling Initiative (NMPI)," has been authorized by CMS.

The State assures compliance with Section 1927 of the Social Security Act. Drugs of federal rebate participating manufacturers are covered. Policies for the supplemental rebate program for Medicaid beneficiaries are as follows:

- a) Supplemental rebates received by the State in excess of those required under the national drug rebate agreement will be shared with the Federal government on the same percentage basis as applied under the national rebate agreement.
- b) Supplemental rebates are for the Medicaid population only.
- c) The State will be negotiating supplemental rebates in addition to the federal rebates provided for in Title XIX. Rebate agreements between the State and a pharmaceutical manufacturer will be separate from the federal rebates.
- d) All drugs covered by the program, irrespective of placement on the recommended drug list, will comply with the provisions of the national drug rebate agreement.
- e) The State is in compliance with reporting requirements for utilization and restrictions to coverage. Pharmaceutical manufacturers may audit utilization data. The unit rebate amount is confidential and cannot be disclosed for purposes other than rebate invoicing and verification.
- f) Participation in the Magellan Medicaid Administration\_National Medicaid Pooling Initiative (NMPI) will not limit the State's ability to negotiate state-specific supplemental rebate agreements for specific drug classes that are not part of the NMPI. These agreements must be authorized by CMS.

12.a. Prescribed Drugs (continued)

- (7) Drugs of manufacturers who do not participate in the supplemental rebate program will be made available to Medicaid recipients through prior authorization (PA). Payment of supplemental rebates results in a drug being included on the PDL and/or the recommended drug list.

Certain products may be limited by on-line clinical or fiscal edits to monitor appropriate utilization and secure cost savings.

North Carolina is establishing a Preferred Drug List (PDL) with PA for drugs not included on the PDL pursuant to 42 USC § 1396r-8. PA is established for certain drug classes, particular drugs or medically accepted indication for uses and doses.

The State will appoint a Pharmacy and Therapeutics Committee or utilize the drug utilization review committee in accordance with Federal law.

The State ensures that the PDL is consistent with Medicaid goals and objectives. The State will seek continuity of care of patients who were stabilized on previously prescribed, non-preferred medications. The PDL will address needs of recipients with special and complex medical conditions.

The Program complies with PA requirements set forth in Section 1927(d)(5) of the Social Security Act pertaining to PA programs.

The State ensures that during the contracting process all payments, the methodology for determining payments, and any other information regarding costs and incentives and the PDL development are disclosed by the vendor. Information includes any and all payment from manufacturers, distributors and other entities involved in the sale of pharmaceuticals.

The State will conduct an annual evaluation with a public report of any multi-state or state-specific PDL, PA or supplemental rebate agreement regarding the cost savings associated with the State participation and impact on related services such as hospitalizations.

- (8) In accordance with 42 CFR 431.54 and the Medicaid State Plan section 4.10, the State has the authority to lock-in recipients who over-utilize Medicaid services. The State will lock Medicaid enrollees into a single pharmacy and prescriber when the Medicaid enrollee's utilization of selected medications meets the lock-in criteria approved by the North Carolina Physicians Advisory Group.

**INTENTIONALLY LEFT BLANK**

TN No.: 12-006  
Supersedes  
TN No.: 10-032

Approval Date: 11-21-12

Effective Date: 4/15/2012

State Plan Under Title XIX of the Social Security Act  
Medical Assistance Program  
State: NORTH CAROLINA

Medicaid Program: Requirements Relating to Covered Outpatient Drugs for the Categorically Needy  
**12.a. PRESCRIBED DRUGS**

Citation (s)	Provision (s)
USC 1935(d)(1)	Effective January 1, 2006, the Medicaid agency will not cover any Part D drug for full-benefit dual eligible individuals who are entitled to receive Medicare benefits under Part A or Part B.

TN No.: 06-001  
Supersedes  
TN No.: NEW

Approval Date: 04/04/06

Effective Date: 01/01/2006

State Plan Under Title XIX of the Social Security Act  
Medical Assistance Program  
State: NORTH CAROLINA

Medicaid Program: Requirements Relating to Covered Outpatient Drugs for the Categorically Needy

---

---

**12.a. PRESCRIBED DRUGS continued**

Citation (s)

USC 1927(d)(2) and  
1935(d)(2)

Provision (s)

The Medicaid agency provides coverage for the following excluded or otherwise restricted drugs or classes of drugs, or their medical uses to all Medicaid recipients, including full benefit dual eligible beneficiaries under the Medicare Prescription Drug Benefit – Part D.

(1) The following excluded drugs are covered:

(a) Non-prescription drugs

North Carolina (NC) will only cover selected rebateable over the counter (OTC) products when not covered by the prescription drug plans (PDPs). Examples of OTC drugs covered are: Insulin products, non-sedating antihistamines e.g. Loratadine OTC and Claritin OTC, proton pump inhibitors e.g. Prilosec OTC.

State Plan Under Title XIX of the Social Security Act  
Medical Assistance Program  
State: NORTH CAROLINA

Medicaid Program: Requirements Relating to Covered Outpatient Drugs for the Categorically Needy

=====

**12.a. PRESCRIBED DRUGS continued**

Citation (s)	Provision (s)
USC 1927(d)(2) and 1935(d)(2)	(2) The following excluded drugs are not covered: (a) Agents when used for anorexia, weight loss, weight gain (b) Agents when used to promote fertility (c) Agents when used for cosmetic purposes or hair growth (d) Covered outpatient drugs which the manufacturer seeks to require as a condition of sale that associated tests or monitoring services be purchased exclusively from the manufacturer or its designee (e) Agents when used for the symptomatic relief of cough and colds. All legend products that contain expectorants or cough suppressants. Examples are: expectorant/antitussive combination, antihistamine/decongestant/antitussive combination, antihistamine/decongestant/expectorant combination, antihistamine/decongestant/expectorant/antitussive combination, antihistamine/expectorant combination, antihistamine/antitussive, antitussive/decongestant/analgesic/ expectorant, and antitussive/decongestant/analgesic. (f) All legend vitamins and mineral products, except prenatal vitamins and fluoride.



12.b Dentures

See Attachment 3.1-A.1 Page 13d under “Dental Services” Section 10.g. for denture, partial denture and relines limitations.

- 12.c Medically necessary orthotic and prosthetic devices are covered by the Medicaid program when prescribed by a qualified licensed healthcare practitioner and supplied by a qualified provider. Only items determined to be medically necessary, effective and efficient are covered. Items which require prior approval are indicated by an asterisk beside the HCPCS code on the Orthotic and Prosthetic Fee Schedule. This fee schedule is located at [www.dhhs.state.nc.us/dma/fee/fee.htm](http://www.dhhs.state.nc.us/dma/fee/fee.htm).

A qualified orthotic and prosthetic device provider must be approved by the Division of Medical Assistance. The provider requirements are published in Medicaid Clinical Coverage Policies on the NC Division of Medical Assistance website ([www.dhhs.state.nc.us/dma/dme/5B.pdf](http://www.dhhs.state.nc.us/dma/dme/5B.pdf)).

Prior approval is required for certain orthotic and prosthetic devices. The decision to require prior approval for a specific procedure, product or service and the requirements that must be met for prior approval are based on evaluation of the factors such as: utilization; efficacy; safety; potential risk to patients; potential for misuse or abuse; high cost; the availability of more cost effective or equivalent procedures, products and services; and legislative mandate. High cost is cost in comparison to other covered items and related maintenance. Such a designation would usually be arrived at by a team of DMA staff from fiscal, programmatic and Program Integrity areas. Whether the recipient gets the item or not is dependent on the rationale for medical need and the unavailability of another less costly item that would adequately address the need. Session Law 2004-124 states “medically necessary prosthetics and orthotics are subject to prior approval and utilization review.” Specific prior approval requirements are published in Medicaid Clinical Coverage Policies on the NC Division of Medical Assistance website ([www.dhhs.state.nc.us/dma/dme/5B.pdf](http://www.dhhs.state.nc.us/dma/dme/5B.pdf)).

*\*EPDST Orthotic and Prosthetic Information is located at: Attachment 3.1-A.1, Page 7b.*

12.d Eyeglasses

- (1) All visual aids require prior approval.
- (2) No eyeglass frames other than frames made of zylonite, metal or combination zylonite and metal shall be covered.
- (3) Eyeglass repair or replacement, or any other service costing five dollars \$5.00 or less, shall not be covered.

**13. d. Diagnostic, Screening, Treatment, Preventive and Rehabilitative Services**

These services are available to categorically needy and medically needy recipients. Services provided under this section are provided by licensed practitioners (within their scope of practice as determined by the North Carolina Practice Acts per discipline) or programs/agencies for the mentally ill and substance abusers certified as meeting the program standards of the Commission on Mental Health, Developmental Disabilities and Substance Abuse Services or as Critical Access Behavioral Health Care Agencies (CABHA), and directly enrolled in Medicaid. See Section 4.b.(8) in this Attachment 3.1-A.1 for a description of a CABHA. Staff of the agency providing services will also meet requirements set forth in Federal regulations or the requirements for one of the three categories described in the North Carolina Practice Act.

**Critical Access Behavioral Health Agencies (CABHA):**

Critical Access Behavioral Health Agencies (CABHA), for profit, not for profit, public, or private behavioral health care, behavioral health services provider agencies, will be certified by the North Carolina Department of Health and Human Services (the Department) as meeting the following staffing, and operational certification requirements.

A Critical Access Behavioral Health Agency must meet all statutory, rule and policy requirements for Medicaid mental health and substance abuse service provision and monitoring; be determined to be in good standing with the Department; and have a three year (or longer) accreditation from an accrediting body recognized by the Secretary of the Department of Health and Human Services. State statutory requirements regulating the provision of mental health and substance abuse services are in North Carolina General Statute, Chapter 122C; administrative rules relating to these services are in 10A NCAC 27 and clinical policy requirements are specified in Medicaid Clinical Policy Section 8. Medicaid and enrollment policy require compliance with Federal Medicaid Policy relating to confidentiality, record retention, fraud and abuse reporting and education, documentation, staff qualifications and compliance with clinical standards for each service.

Required staff for a CABHA includes a Medical Director; a Clinical Director and a Quality Management/Training Director. Each CABHA is required to offer at a minimum the following five services:

1. Comprehensive clinical assessment, which is defined as a face to face evaluative review by a qualified licensed practitioner, of a recipient's medical, psychological, familial, social and psychiatric treatment history; current mental status and functioning, strengths, natural supports, current treatment and medication regime, for the purpose of developing a diagnostic formulation of the recipient's treatment needs and treatment plan; may be provided under Diagnostic Assessment, (Attachment 3.1-A.1, Page 15a.1) or under Behavioral Health Rehabilitative Services (Pages 15a.16 -17).
2. Medication management, defined as pharmacologic management including review of medication use, both current and historical if indicated; evaluation of symptoms being treated, side effects and effectiveness of current medication(s), adjustment of medications if indicated, and prescription provided by a medical professional practicing within the scope of his or her licensure; may be provided under Physician Services, Attachment 3.1-A.1, Page 7h or under Behavioral Health Rehabilitative Services, Page 15a.16-17.
3. Outpatient therapy, defined as outpatient psychotherapy including individual insight oriented, behavior modifying, and/or supportive psychotherapy; interactive psychotherapy; family psychotherapy; and group psychotherapy. Service can be billed by all licensed clinicians according to their scope of practice, as indicated in Attachment 3.1-A.1 on Page 15a.16-17.
4. At least two additional mental health and/or substance abuse services from the list below for which the agency has been credentialed from the Local Management Entity in the same region where it provides the services and which provide a continuum of service which is age and disability specific. There is a description of each of the services, including who provides the services and their qualifications in the State plan, in Attachment 3.1-A.1, on the Pages as indicated below:

**13. d. Diagnostic, Screening, Preventive, Treatment and Rehabilitative Services (continued)**

These services must include two or more of the following as described in Attachment 3.1-A.1 of the State's plan on the pages indicated:

Services	Page Reference
Intensive In-Home (IIH)	Page 7c.6
Community Support Team (CST)	Page 15a.6
Substance Abuse Intensive Outpatient Program (SAIOP)	Pages 7c.8 & 15a.9-A
Substance Abuse Comprehensive Outpatient Treatment (SACOT)	Page 15a.10
Child and Adolescent Day Treatment	Page 7c.4
Psychosocial Rehabilitation (PSR)	Page 15a.3
Assertive Community Treatment Team (ACTT)	15a.7
Multi-Systemic Therapy (MST)	Page 7c.7
Partial Hospitalization (PH)	Pages 7c.5 & 15a.4
Substance Abuse Medically Monitored Community Residential Treatment	Page 15a.11-A
Substance Abuse Non-Medical Community Residential Treatment	Page 15a.11
Outpatient Opioid Treatment	Page 15a.9
(Therapeutic Foster Care) Child Residential Level II – Family Type	Page 15a.19
Child Residential Level II – Program Type	Page 15a.19
Child Residential Level III and IV	Page 15a.20

CABHAs and non-CABHA agencies may provide Comprehensive Clinical Assessments, Medication Management, and Outpatient Therapy.

Only CABHAs will be able to provide Community Support Team, Intensive In-Home, Child and Adolescent Day Treatment (both for individuals under 21) after December 31, 2010.

State Plan Under Title XIX of the Social Security Act  
Medical Assistance Program  
State: NORTH CAROLINA

---

---

**13. d. Diagnostic, Screening, Preventive, Treatment and Rehabilitative Services (continued)**

CABHAs must coordinate with other provider participants, Carolina Access and other primary care providers to improve the coordination of services within the Local Management Entity's community of providers.

Rehabilitative Services include the following:

- A. Medically necessary diagnostic evaluations or assessments (Diagnostic Assessment) identify the existence, nature and extent of illness. The services may include a systematic appraisal of mental, psychological, physical, behavioral, functional, social, economic and/or intellectual limitations and resources of the individual in order to determine the nature and extent of illness. This information will be used in the formulation of an individualized person centered plan for the recipient in accordance with 42 CFR 430.130(a).
- B. Other medically necessary diagnostic, screening, treatment, preventive and rehabilitative (ODSPR) services for the mentally ill, developmentally disabled and substance abusers are covered benefits when medically necessary. Screening services means the use of standardized tests given under medical direction. Diagnostic, preventive, or rehabilitative services must be ordered by a physician, licensed psychologist, physician's assistant or nurse practitioner practicing within the scope of his/her practice according to Chapter 90 of the North Carolina General Statutes in accordance with 42 CFR 430.130(d).

Covered services are provided to recipients in their residence or in a community setting other than in a public institution (IMD), jail or detention facility.

The following services will be covered when a determination is made that the service will meet specific behavioral health needs of the recipient. Specific services must ameliorate diagnosable conditions or prevent the anticipated deterioration of the patient's condition. Family services must be to the exclusive benefit of the Medicaid eligible beneficiary, and is designed to address a specific rehabilitative goal.

State Plan Under Title XIX of the Social Security Act  
Medical Assistance Program  
State: NORTH CAROLINA

---

13. D. Diagnostic, Screening, Treatment, Preventive and Rehabilitative Services  
Description of Services

(i) Psychotherapy Services:

For the complete description of the service providers, their qualifications, service limitations and service descriptions, see Attachment 3.1-A pages 15a.16 and 15a.7

(ii) Diagnostic Assessment

This is a clinical face-to-face evaluation of a beneficiary's MH/DD/SAS condition that will establish a need for the enhanced benefit package of services. It is a team service and must include evaluations by either, a physician, physician assistant, nurse practitioner or licensed psychologist who can sign an order for services and a licensed or certified practitioner with expertise in MH/DD/SAS as appropriate and consist of the following:

- a chronological general health and behavioral health history (includes both mental health and substance abuse) of the beneficiary's symptoms, treatment, treatment response and attitudes about treatment over time, emphasizing factors that have contributed to or inhibited previous recovery efforts; biological, psychological, familial, social, developmental and environmental dimensions and identified strengths and weaknesses in each area;
- a description of the presenting problems, including source of distress, precipitating events, associated problems or symptoms, recent progressions, and current medications;
- a strengths/problem summary which addresses risk of harm, functional status, co-morbidity, recovery environment, and treatment and recovery history;
- diagnoses on all five (5) axes of DSM-IV;
- evidence of an interdisciplinary team progress note that documents the team's review and discussion of the assessment;
- a recommendation regarding target population eligibility; and
- evidence of beneficiary participation including families, or when applicable, guardians or other caregivers.

Documentation must include the following elements:

- a chronological general health and behavioral health history (includes both mental health and substance abuse) of the beneficiary's symptoms, treatment, treatment response and attitudes about treatment over time, emphasizing factors that have contributed to or inhibited previous recovery efforts; biological, psychological, familial, social, developmental and environmental dimensions and identified strengths and weaknesses in each area;
- a description of the presenting problems, including source of distress, precipitating events, associated problems or symptoms, recent progressions, and current medications;
- strengths/problem summary which addresses risk of harm, functional status, co-morbidity, recovery environment, and treatment and recovery history;
- diagnoses on all five (5) axes of DSM-IV;
- evidence of an interdisciplinary team progress note that documents the team's review and discussion of the assessment;

State Plan Under Title XIX of the Social Security Act  
Medical Assistance Program  
State: NORTH CAROLINA

---

INTENTIONALLY LEFT BLANK

---

TN No: 12-009  
Supersedes  
TN No: 09-024

Approval Date: 10-17-12

Effective Date: 07/01/2012

State Plan Under Title XIX of the Social Security Act  
Medical Assistance Program  
State: NORTH CAROLINA

---

INTENTIONALLY LEFT BLANK

---

TN No: 12-009  
Supersedes  
TN No: 09-024

Approval Date: 10-17-12

Effective Date: 07/01/2012

13. D. Diagnostic, Screening, Treatment, Preventive and Rehabilitative Services (Continued)

Provider Agency Qualifications and Qualifications for Staff Employed by Agencies  
Enrolled with Medicaid.

*Please refer to chart included with this SPA for staff qualifications for each specific service.*

TN No: 07-003  
Supersedes  
TN No: NEW

Approval Date: 11/24/08

Effective Date: 01/01/07



**Staff Qualifications for Each Specific Service.**

Service	Agency Qualifications		Staff Qualifications					
			Authorization	See Definitions for QP, AP, PP in Text of SPA:		Medical Coverage		
	Licensed	Credentialed	Service Ordered by: MD, Nurse Practitioner, Physicians Assistant or PhD Psychologist	Qualified Professional (QP), includes SA Professionals	Under Supervision of a Qualified Professional:		Medical Oversight/ Participation by:	
	All facilities must be 16 beds or less				Associate Professional	Para-Professional	Psychiatrist/ MD	Registered Nurse* RNs are considered QPs as well
Psychosocial Rehabilitation	X	X	X	X	X	X		
Partial Hospitalization	X	X	X	X	X	X	X	
Mobile Crisis Management		X		X (Nurse, LCSW or Psychologist)		X	X (Must be available for face to face or tel. Consult)	
Community Support Team (adults)		X	X	X (required)	X	X		
Assertive Community Treatment (ACTT) <i>minimum required per team</i>		X	X	X		X (includes certified peer specialist)	X	X
Professional Treatment Services in a Facility Based Crisis Program	X	X	X	X	X	X	X	
Opioid Treatment	X	X	X				Must be provided by RN, LPN, Pharmacist or MD	
Substance Abuse (SA) Intensive Outpatient	X		X	X	X	X		
SA Comprehensive Output Treatment	X	X	X	X	X	X	Recipients must have access to MD assessment and tx.	

TN No: 12-014  
Supersedes  
TN No: 07-003

Approval Date: 11-21-12

Effective Date: 7/01/2012

**Staff qualifications for each specific service. (Continued)**

Service	Agency Qualifications		Staff Qualifications					
			Authorization	See Definitions for QP, AP, PP in Text of SPA:			Medical Coverage	
	Licensed		Credentialed	Service Ordered by: MD, Nurse Practitioner, Physicians Assistant or PhD Psychologist			Qualified Professional (QP), includes SA Professionals	
SA Non-Medical Community Residential Tx	X	X	X	X	X	X		
SA Medically Monitored Residential Tx	X	X	X	X	X	X	X	X
Ambulatory Detoxification	X	X	X	X	X	X	X (provides assessment w/n 24 hrs.)	X (provides admission assessment /monitors tx
Non-hospital Medical Detoxification	X	X	X	X	X	X	X (provides assessment w/n 24 hrs.)	X (provides admission assessment /monitors tx
Medically Monitored or Alcohol Drug Addiction Tx Center Detoxification/ Crisis Stabilization	X	X	X	X	X	X	X Service delivered by medical and nursing staff/24 hour medically supervised evaluation and withdrawal management	

TN No: 12-014  
Supersedes  
TN No: 07-003

Approval Date: 11-21-12

Effective Date: 7/01/2012

13. D. Diagnostic, Screening, Treatment, Preventive and Rehabilitative Services (Continued)

Provider Agency Qualifications:

The Community Intervention Service provider has met the requirements either with:

The required Licensure through the Division of Health Service Regulation (DHSR); and /or Credentialing through the PIHP indicating that the provider is in compliance with requirements for the specific service per service specific Credentialing protocols.

These pre-requisites must be completed prior to enrollment with the Division of Medical Assistance (DMA). Additionally, providers must be accredited by a national accrediting body within three years of enrollment into Medicaid; per requirement during this SPA's effective dates.

Qualifications for Staff Employed by Agencies Enrolled with Medicaid

- i) Paraprofessional  
"Paraprofessional" within the mental health and substance system means an individual who has a GED or high school diploma (or no GED or high school diploma if employed prior to November 1, 2001). Supervision shall be provided by a qualified professional or associate professional with the population served.
- ii) Associate Professional (AP)  
"Associate Professional" within the mental health and substance abuse services system means an individual who is a:
  - graduate of college or university with a Masters degree in a human service field and less than one year of full time post-graduate mental health or substance abuse experience with the population served or a substance abuse professional with less than one year of full-time, post-graduate degree supervised experience in alcoholism and drug abuse counseling. Supervision shall be provided by a qualified professional with the population served until the individual meets one year of experience; or
  - graduate of college or university with a bachelor's degree in a human service field with less than two years of full-time post-bachelor's degree mental health or substance abuse experience with the population served, or a substance abuse professional with less than two years post bachelor's degree accumulated supervised experience in alcoholism and drug abuse counseling. Supervision shall be provided by a qualified professional with the population served until the individual meets two years of experience; or
  - graduate of a college or university with a bachelor's degree in a field other than human services with less than four years of full-time, post bachelor's degree accumulated supervised experience in mental health or substance abuse with the population served. Supervision shall be provided by a qualified professional with the population served until the individual meets four years of experience; or

13. D. Diagnostic, Screening, Treatment, Preventive and Rehabilitative Services (Continued)

- registered nurse who is licensed to practice in the State of North Carolina by the North Carolina Board of Nursing with less than four years of full-time accumulated experience in mental health or substance abuse with the population served. Supervision shall be provided by a qualified professional with the population served until the individual meets four years of experience.
- (iii) Qualified Professional (QP)
- “Qualified Professional” within the mental health and substance abuse system means:
- an individual who holds a license, provisional license, certificate, registration or permit issued by the governing board regulating a human service profession, except a registered nurse who is licensed to practice in the State of North Carolina by the North Carolina Board of Nursing, who also has four years of full-time accumulated experience in MH/SA with the population served; or
  - a graduate of a college or university with a Masters degree in a human service field and one year of full-time, post-graduate degree experience with the population served or a substance abuse professional with one year of full-time, post-graduate degree accumulated supervised experience in alcoholism and drug abuse counseling; or
  - a graduate of college or university with a bachelor’s degree in a human service field and two years of full-time, post-bachelor’s degree experience with the population served or a substance abuse professional who has two years full-time, post-bachelor’s degree accumulated supervised alcoholism and drug abuse counseling; or
  - a graduate of a college or university with a bachelor’s degree in a field other than human services with four years of full-time, post-bachelors degree accumulated MH/SA experience with the population served.

This category includes Substance Abuse Professional, Certified Substance Abuse Counselors (CSAC), Certified Clinical Supervisor (CCS), Licensed Clinical Addictions Specialist (LCAS)\*

The full descriptions of categories of providers are found in the North Carolina Administrative Code.

13. D Diagnostic, Screening, Treatment, Preventive and Rehabilitative Services (Continued)

Supervision is provided as described below:

Covered services are provided to recipients by agencies directly enrolled in the Medicaid program which employ qualified professionals, associate professional and paraprofessionals. Medically necessary services delivered by associate and paraprofessionals are delivered under the supervision and direction of the qualified professional. The qualified professional personally works with consumers to develop the person centered individualized treatment plan and meets with consumers periodically during the course of treatment to monitor the services being delivered and to review the need for continued services. The supervising qualified professional assumes professional responsibility for the services provided by associate and paraprofessionals and spends as much time as necessary directly supervising services to ensure that recipients are receiving services in a safe and efficient manner in accordance with accepted standards of practice. The terms of the qualified professional's employment with the directly enrolled agency providing service ensures that the qualified professional is adequately supervising the associate and paraprofessionals. The agencies ensure that supervisory ratios are reasonable and ethical and provide adequate opportunity for the qualified professional to effectively supervise the associate and paraprofessional staff assigned. Documentation is kept to support the supervision provided to associate and paraprofessional staff in the delivery of medically necessary services.

TN No: 07-003  
Supersedes  
TN No: NEW

Approval Date: 11/24/08

Effective Date: 01/01/07

State Plan Under Title XIX of the Social Security Act  
Medical Assistance Program  
State: NORTH CAROLINA

---

INTENTIONALLY LEFT BLANK

---

TN No: 12-009  
Supersedes  
TN No: 09-024

Approval Date: 10-17-12

Effective Date: 07/01/2012

State Plan Under Title XIX of the Social Security Act  
Medical Assistance Program  
State: NORTH CAROLINA

---

INTENTIONALLY LEFT BLANK

---

TN No: 12-009  
Supersedes  
TN No: 09-024

Approval Date: 10-17-12

Effective Date: 07/01/2012

State Plan Under Title XIX of the Social Security Act  
Medical Assistance Program  
State: NORTH CAROLINA

---

INTENTIONALLY LEFT BLANK

---

TN No: 12-009  
Supersedes  
TN No: 09-024

Approval Date: 10-17-12

Effective Date: 07/01/2012



State Plan Under Title XIX of the Social Security Act  
Medical Assistance Program  
State: NORTH CAROLINA

---

INTENTIONALLY LEFT BLANK

---

TN No: 12-009  
Supersedes  
TN No: 09-024

Approval Date: 10-17-12

Effective Date: 07/01/2012

State Plan Under Title XIX of the Social Security Act  
Medical Assistance Program  
State: NORTH CAROLINA

---

INTENTIONALLY LEFT BLANK

---

TN No: 12-009  
Supersedes  
TN No: 09-024

Approval Date: 10-17-12

Effective Date: 07/01/2012

State Plan Under Title XIX of the Social Security Act  
Medical Assistance Program  
State: NORTH CAROLINA

---

---

INTENTIONALLY LEFT BLANK

---

TN No: 12-009  
Supersedes  
TN No: 09-024

Approval Date: 10-17-12

Effective Date: 07/01/2012

State Plan Under Title XIX of the Social Security Act  
Medical Assistance Program  
State: NORTH CAROLINA

---

INTENTIONALLY LEFT BLANK

---

TN No: 12-009  
Supersedes  
TN No: 09-024

Approval Date: 10-17-12

Effective Date: 07/01/2012

State Plan Under Title XIX of the Social Security Act  
Medical Assistance Program  
State: NORTH CAROLINA

---

INTENTIONALLY LEFT BLANK

---

TN No: 12-009  
Supersedes  
TN No: 09-024

Approval Date: 10-17-12

Effective Date: 07/01/2012

State Plan Under Title XIX of the Social Security Act  
Medical Assistance Program  
State: NORTH CAROLINA

---

---

INTENTIONALLY LEFT BLANK

---

TN No: 12-009  
Supersedes  
TN No: 09-024

Approval Date: 10-17-12

Effective Date: 07/01/2012

State Plan Under Title XIX of the Social Security Act  
Medical Assistance Program  
State: NORTH CAROLINA

---

13. D. Diagnostic, Screening, Treatment, Preventive and Rehabilitative Services (*continued*)  
Description of Services (42 CFR 30.130(a))

(iv) Psychosocial Rehabilitation

Psychosocial Rehabilitation (PSR) is a service designed to help adults with psychiatric disabilities regain and/or restore an individual to his/her best age-appropriate functional level according to an individualized treatment plan, which addresses the adult's assessed needs. The activities included in PSR shall be included in the treatment plan and intended to achieve the identified beneficiary's treatment plan goals or objectives. Components that are not provided or directed exclusively toward the treatment of the beneficiary are not eligible for Medicaid reimbursement

The service components include:

- Behavioral intervention and management, including anger management.
- Assisting the individual to develop daily living skills specific to managing their own home, including managing their money, medications, and using community resources and other self care requirements.
- Assisting in the restoration of social skills, adaptive skills, enhancement of communication and problem solving skills, monitoring of changes in psychiatric symptoms/or functioning.
- Assisting the individual and family members or other collaterals to identify strategies or treatment options associated with the individual's mental illness, with the goal of minimizing the negative effects of mental illness symptoms or emotional disturbances or associated environmental stressors which interfere with the individual's daily living, financial management, housing, academic and/or employment progress, personal recovery or resilience, family and/or interpersonal relationships, and community integration.
- Participation in and utilization of strengths based planning and treatments which include assisting the individual and family members or other collaterals with identifying strengths and needs, resources, natural supports and developing goals and objectives to utilize personal strengths, resources, and natural supports to address functional deficits associated with their mental illness.
- Individual supportive counseling, solution focused interventions, emotional and behavioral management, and problem behavior analysis with the individual, with the goal of assisting the individual with developing and implementing social, interpersonal, self care, daily living and independent living skills to restore stability, to support functional gains, and to adapt to community living.

Services provided at a work site must not be job task oriented. Any services or components of services the basic nature of which are to supplant housekeeping, homemaking, or basic services for the convenience of a person receiving covered services (including housekeeping, shopping, child care, and laundry services) are non-covered.

The Psychosocial Rehabilitation program shall be under the direction of a person who meets the requirements specified for Qualified Professional status. The Qualified Professional is responsible for supervision of other program staff which may include Associate Professionals and Paraprofessionals. All staff must have the knowledge, skills, and abilities required by the population and age to be served.

---

TN No.: 12-010  
Supersedes  
TN No.: 12-009

Approval Date: 06-14-13

Effective Date: 07/01/2012

State Plan Under Title XIX of the Social Security Act  
Medical Assistance Program  
State: NORTH CAROLINA

---

13. D. Diagnostic, Screening, Treatment, Preventive and Rehabilitative Services (continued)  
Description of Services (42 CFR 30.130(a))

Qualified Professional (QP): In addition to the following components, the QP may provide any activity listed under Associate Professional or Paraprofessional: developing, implementing, and monitoring the Person Centered Plan; behavioral interventions/management; social and other skill restoration, adaptive skill training; enhancement of communication and problem solving skills, anger management, family support, medication monitoring, monitoring of changes in psychiatric symptoms/or functioning.

Associate Professional (AP): In addition to the following components, the AP may provide the activities listed under Paraprofessionals: behavioral interventions/management; social and other skill restoration, adaptive skill training; restoration of communication and problem solving skills, anger management, family support, medication monitoring, monitoring of changes in psychiatric symptoms/or functioning.

Paraprofessional: The Paraprofessional may provide restoration of skills needed for community living, use of leisure time, prevocational activities and pursuit of needed education services.

**Operating Requirements:**

Each facility shall have a designated program director. A minimum of one staff member on-site to each eight or fewer beneficiaries in average daily attendance shall be maintained.

PSR is available for a period of 5 or more hours per day. There should be a supportive, therapeutic relationship between providers and the beneficiary. It is provided in a licensed facility with staff to beneficiary ratio of 1:8. This service is provided to outpatients by a mental health organization that meets State licensure requirements, and providers of the services will meet the appropriate Federal requirements or the State requirements. Documentation must include: a weekly full service note that includes the beneficiary's name, Medicaid identification number, date of service, purpose of contact, describes the provider's interventions, includes the time spent performing the interventions, effectiveness of the intervention, and the signature of the staff providing the service. This service must be ordered by an MD, NP, PA or PhD psychologist. Prior approval will be required by the designated Medicaid vendor. This initial prior approval process will ensure that the level of the service is appropriate and concurrent reviews will determine the ongoing medical necessity for the service or the need to move up or down the continuum of services to another level of care.

---

TN No.: 12-009  
Supersedes  
TN No.: NEW

Approval Date: 06-14-13

Effective Date: 07/01/2012



State Plan Under Title XIX of the Social Security Act  
Medical Assistance Program  
State: NORTH CAROLINA

---

13. D. Diagnostic, Screening, Treatment, Preventive and Rehabilitative Services (continued)  
Description of Services (42 CFR 30.130(a))

- (v) Partial Hospital (PH)  
This is a short term service for acutely mentally ill adults which provides a broad range of intensive therapeutic approaches which may include:
- Individual/group therapies,
  - Increase the individual's ability to relate to others,
  - Community living skills/training,
  - Coping skills,
  - Medical services; and
  - This is used as a step up to inpatient or a step down from inpatient.

Physician involvement is required. This service must be offered at a minimum of 4 hours per day, 5 days/week. Clinical criteria (medical necessity criteria for admission and continued stay) are embedded in the service definition. Documentation must include: a daily full service note that includes the beneficiary's name, Medicaid identification number, date of service, purpose of contact, describes the provider's interventions, time spent performing the intervention, effectiveness of the intervention, and the signature of the staff providing the service. The service must be ordered by a physician, licensed psychologists, physician's assistant or nurse practitioner and prior approval will be required via the statewide UR vendor or by an approved LME contracted with the Medicaid Agency and meeting the same standards and requirements as the statewide vendor. This initial prior approval process will ensure that the level of the service is appropriate and concurrent reviews will determine the ongoing medical necessity for the service or the need to move up or down the continuum of services to another level of care.

**Service Operations Requirements:**

Staff shall include at least one qualified mental health professional.

- (a) Each facility serving minors shall have:
- (1) A program director who has a minimum of two years experience in child or adolescent services and who has educational preparation in administration, education, social work, nursing, psychology or a related field; and
  - (2) one staff member present if only one beneficiary is in the program, and two staff members present when two or more beneficiaries are in the program.
- (b) each facility shall have a minimum ratio of one staff member present for every six beneficiaries at all times.
- (c) a physician shall participate in diagnosis, treatment planning, and admission and discharge decisions. This physician shall be a psychiatrist unless a psychiatrist is unavailable or for other good cause cannot be obtained.

13. D. Diagnostic, Screening, Treatment, Preventive and Rehabilitative Services (continued)  
Description of Services

(vi) Mobile Crisis Management

This involves all supports, services and treatments necessary to provide integrated crisis response, crisis stabilization interventions and crisis prevention activities. It is available 24/7/365 and provides immediate evaluation, triage and access to acute mh/dd/sas services, treatment, supports to effect symptom reduction, harm reduction and/or to safely transition persons in acute crisis to the appropriate environment for stabilization. It is provided by a team that includes a Qualified Professional who must be a nurse, a clinical social worker or psychologist. Teams include substance abuse professionals, and a psychiatrist must be available for face to face or telephone consults. Paraprofessionals with crisis management experience may also be included on the team but must work under the supervision of a professional. Experience with the appropriate disability group is required and 20 hours of crisis intervention training within the first 90 days of employment is necessary. The maximum length of the service is 24 hours per episode and prior authorization will be required via the statewide UR vendor or by an approved LME contracted with the Medicaid Agency and meeting the same standards and requirements as the statewide vendor after the first 8 hours for the remaining 16 hours. Documentation must include: a service note that includes the recipient's name, Medicaid identification number, date of service, purpose of contact, describes the provider's interventions, includes the time spent performing the interventions, effectiveness of the intervention, and the signature of the staff providing the service.

NOTE: This has a limitation because the service requires stabilization or movement into an environment that can stabilize.

**13. d. Diagnostic, Screening, Preventive, Treatment and Rehabilitative Services (continued)**  
**Description of Services**

(vii) Community Support Team (CST) - (adults)

Services provided by this team consist of mental health and substance abuse services and supports necessary to assist adults in achieving rehabilitation and recovery goals. It assists individuals to gain access to necessary services; reduce psychiatric and addiction symptoms; and develop optimal community living skills. The services include assistance and support to individuals in crisis situation; service coordination; psycho education and support for individuals and their families; independent living skills; development of symptom monitoring and management skills, monitoring medications and self-medication.

- Assist individuals to gain access to necessary services to reduce psychiatric and addiction symptoms,
- Assistance and support for individuals in crisis situations,
- Service coordination,
- Psycho-education,
- Individual restorative interventions for development of interpersonal, community coping and independent living skills; and
- Monitoring medications and self medication.

Documentation must include: a service note that includes the recipient's name, Medicaid identification number, date of service, purpose of contact, describes the provider's interventions, includes the time spent performing the interventions, effectiveness of the intervention, and the signature of the staff providing the service.

The CST provider assumes the role of advocate, broker, coordinator and monitor of the service delivery system on the behalf of the recipient. The service must be ordered and prior approval will be required. A CST team will be comprised of 3 staff persons one of which is the team leader and must be a QP. The other two may be a QP, AP or a paraprofessional. The team maintains a consumer to practitioner ratio of no more than fifteen consumers per staff person. All staff providing this service must have a minimum of one year documented experience with the adult population and completion of a minimum of twenty hours of crisis management and community support team service definition required within the first 90 days of hire. Clinical criteria are imbedded in the definition as well as service limitations to prevent duplication of services. It must be ordered by either, a physician, physician assistant, nurse practitioner or licensed psychologist. After December 31, 2010, this service can only be provided by and billed by a Critical Access Behavioral Health Care Agency (CABHA). Prior approval will be required via the statewide UR vendor or by an approved LME contracted with the Medicaid Agency and meeting the same standards and requirements as the statewide vendor. This initial prior approval process will ensure that the level of the service is appropriate and concurrent reviews will determine the ongoing medical necessity for the service or the need to move up or down the continuum of services to another level of care.

**NOTE:** This service is used as an intervention to avoid need for a higher level of care or as a step down from a higher level of care. It is an ACTT "lite" service.

State Plan Under Title XIX of the Social Security Act  
Medical Assistance Program  
State: NORTH CAROLINA

---

13. D. Diagnostic, Screening, Treatment, Preventive and Rehabilitative Services (continued)  
Description of Services

(viii) Assertive Community Treatment (ACT)

Assertive Community Treatment (ACT) is defined as an individual-centered, recovery-oriented mental health service delivery model for facilitating community living, psychosocial rehabilitation and recovery for persons who have the most severe and persistent mental illnesses, have severe symptoms and impairments, and have not benefited from traditional outpatient programs. ACT is a multi-disciplinary, self-contained clinical team approach with team members providing long-term intensive care in natural community settings. The team provides all mental health services rather than referring individuals to different mental health providers, programs, and other agencies.

The team provides evaluations (an assessment to determine the extent of the problems), outpatient treatment, case management, and community based services (described below) for individuals with mental health and substance abuse diagnoses. Interventions include the following, with a focus on achieving a maximum reduction of physical or mental disability and restoration of a beneficiary to his/her best possible functional level.

- Service coordination
- Crisis assessment and intervention
- Symptom assessment and management
- Individual counseling and psychotherapy, including cognitive and behavioral therapy
- Medication monitoring, administration and documentation
- Substance abuse treatment
- Working with beneficiaries to regain and restore skills to function and have social and interpersonal relationships as well as participate in community-based activities including leisure and employment
- Support and consultation to families and other major supports

ACT is available 24/7/365, in any location except jails, detention centers, clinic settings and hospital inpatient settings. Beneficiary-to-staff ratio is eight-to-one with a maximum of nine-to-one. Documentation must include a service note that includes the beneficiary's name, Medicaid identification number, date of service, purpose of contact, describes the provider's interventions, includes the time spent performing the interventions, effectiveness of the intervention, and the signature of the staff providing the service.

Minimum staff per team includes the following: a Licensed Professional, RN, QP, paraprofessional staff, certified peer specialist, and a psychiatric care provider role filled at least part-time by a physician for a minimum of 16 hours per week for every 60 beneficiaries for the largest teams and a smaller ratio for smaller teams of no less than 16 hours per 50 beneficiaries. The remainder of the psychiatric care provider time may be fulfilled by a nurse practitioner or a physician assistant. The team will provide a median rate of two contacts per week across all individuals served by that team. (This is billed per diem; the claims system is set so it will not reimburse for more than 4 in 1 month.).

---

TN No: 12-010  
Supersedes  
TN No: 07-003

Approval Date: 06-14-13

Effective Date: 07/01/2012

State Plan Under Title XIX of the Social Security Act  
Medical Assistance Program  
State: NORTH CAROLINA

---

13. D. Diagnostic, Screening, Treatment, Preventive and Rehabilitative Services (continued)

Description of Services

(viii) Assertive Community Treatment Team (ACTT) (continued)

The service is intended to provide support and guidance in all functional domains to enhance the beneficiary's ability to remain in the community. No other periodic mental health services can be billed in conjunction with this service. This service must be ordered by an MD, NP, PA or PhD psychologist. Evidenced based best practices for this service have been incorporated into the service definitions. Providers of (ACT) under the State Plan must demonstrate fidelity to the latest Tool for Measurement of Act (TMACT) models of care. This will ensure that all providers maintain fidelity to the current fidelity model as it is updated. Clinical criteria are also included in the definition. Prior approval will be required via the statewide UR vendor or by an approved LME-PIHP contracted with the Medicaid Agency and meeting the same standards and requirements as the statewide vendor. This initial prior approval process will ensure that the level of the service is appropriate and concurrent reviews will determine the ongoing medical necessity for the service or the need to move up or down the continuum of services to another level of care.

Staff Program Operations Requirements

- (a) Team composition. The team shall be interdisciplinary in order to carry out the varied activities needed to meet the complex needs of clients and shall include:
- (1) a qualified professional, appropriate to the diagnosis of the clients being served;
  - (2) a registered nurse;
  - (3) an MD (at least .25 FTE per 50 clients); and
  - (4) one or more paraprofessional staff trained to meet the needs presented by the facility's client population.
- (b) Team qualifications. Each member of the team shall be privileged and supervised based on their training, experience, and qualifications.

INTENTIONALLY LEFT BLANK

INTENTIONALLY LEFT BLANK

INTENTIONALLY LEFT BLANK

---

TN No: 11-010  
Supersedes  
TN No: 10-004

Approval Date: 07-22-11

Effective Date: 07/01/2011



INTENTIONALLY LEFT BLANK

INTENTIONALLY LEFT BLANK

INTENTIONALLY LEFT BLANK

13. D. Diagnostic, Screening, Treatment, Preventive and Rehabilitative Services (continued)  
Description of Services

(ix) Professional Treatment Services in Facility-Based Crisis Programs (FBC)

This existing service serves as an alternative to hospitalization for recipients who have mental illness/ substance abuse disorder. It is a 24 hour residential facility that provides support and crisis services in a community setting. The services are provided under the supervision of a physician with interventions implemented under the physician direction. The purpose is to implement intensive treatment, behavioral management, interventions or detoxification protocols, to stabilize the immediate problems and to ensure the safety of the individual.

- Evaluation (assesses condition),
- Intensive treatment,
- Stabilization (behavioral management),
- Monitoring response to interventions; and
- Provide linkage for other services.

It is offered 7 days/week and must be provided in a licensed facility. At no time will the staff to recipient ratio be less than 1:6 for adult mental health recipients, 1:9 for substance abuse recipients. This is a short term service that does not exceed 15 days and cannot exceed a total of 30 days in a 12 month period. Documentation must include: a daily full service note that includes the recipient's name, Medicaid identification number, date of service, purpose of contact, describes the provider's interventions, includes the time spent performing the interventions, effectiveness of the intervention, and the signature of the staff providing the service. Prior approval will be required via the statewide UR vendor or by an approved LME contracted with the Medicaid Agency and meeting the same standards and requirements as the statewide vendor at the end of 7 days, if additional days are needed. This initial prior approval process will ensure that the level of the service is appropriate and concurrent reviews will determine the ongoing medical necessity for the service or the need to move up or down the continuum of services to another level of care. This service must be provided in a facility with 16 beds or less. Medicaid reimburses only treatment costs.

13. D. Diagnostic, Screening, Treatment, Preventive and Rehabilitative Services (continued)  
Description of Services

(ix) Professional Treatment Services in Facility-Based Crisis Programs (FBC) (continued)

Program Operations Requirements

- (a) Each facility shall maintain staff to client ratios that ensure the health and safety of clients served in the facility.
- (b) Staff with training and experience in the provision of care appropriate to the needs of clients shall be present at all times when clients are in the facility.
- (c) The facility shall have the capacity to bring additional staff on site to provide more intensive supervision, treatment, or management in response to the needs of individual clients.
- (d) The treatment of each client shall be under the supervision of a physician, and a physician shall be on call on a 24-hour per day basis.
- (e) Each direct care staff member shall have access at all times to qualified professionals who are qualified in the disability area(s) of the clients with whom the staff is working.
- (f) Each direct care staff member shall be trained and have basic knowledge about mental illnesses and psychotropic medications and their side effects; mental retardation and other developmental disabilities and accompanying behaviors; the nature of addiction and recovery and the withdrawal syndrome; and treatment methodologies for adults and children in crisis.
- (g) Staff supervision shall be provided by a qualified professional as appropriate to the client's needs

13. D. Diagnostic, Screening, Treatment, Preventive and Rehabilitative Services (continued)  
Description of Services

(x) Opioid Treatment

This existing service is provided through the LMEs for the treatment of Opioid addiction in conjunction with the provision of rehabilitation and medical services. It is provided only for treatment and/or maintenance. The program must be licensed and must meet the Federal Guidelines for this program. Providers will be direct enrolled. It is provided by an RN, LPN, Pharmacist or MD. This service must be ordered by an MD, NP, PA or PhD psychologist. Prior approval will be required via the statewide UR vendor or by an approved LME contracted with the Medicaid Agency and meeting the same standards and requirements as the statewide vendor. This initial prior approval process will ensure that the level of the service is appropriate and concurrent reviews will determine the ongoing medical necessity for the service or the need to move up or down the continuum of services to another level of care.

13. D. Diagnostic, Screening, Treatment, Preventive and Rehabilitative Services (continued)  
Description of Services

(xi) Substance Abuse Intensive Outpatient (SAIOP)

This service provides motivational enhancement and engagement, therapies for recovery, random alcohol/ drug testing, and strategies for relapse prevention, including community and/or other strategies for relapse preventions. These therapies include:

- Individual counseling and support,
- Group counseling and support,
- Family counseling and support,
- Biochemical assays to identify recent drug use (e.g. urine drug screens),
- Strategies for relapse prevention: community and social support systems in treatment,
- Crisis contingency planning,
- Disease management; and
- Treatment support activities that have been adapted or specifically designed for persons with physical disabilities, persons with co-occurring disorders of mental illness and substance abuse/dependence or mental retardation/developmental disabilities and substance abuse/dependence.

SAIOP must be available for a minimum of 3 hours per day. It is operated out of a licensed substance abuse facility but can be provided in a variety of settings. The maximum face to face ratio is an average of not more than 12 recipients to 1 direct service staff based on average daily attendance. This service can only be provided by qualified substance abuse professional staff with the following licenses or certifications: persons who meet the requirements specified for Certified Clinical Supervisor (CCS); Licensed Clinical Addiction Specialist (LCAS); and Certified Substance Abuse Counselor (CSAC). Services may also be provided by staff who meet the requirements specified for QP or AP status for Substance Abuse, under the supervision of a LCAS or CCS. Paraprofessional level providers who meet the requirements for Paraprofessional status and who have the knowledge, skills, and abilities required for the population and age of persons receiving services may deliver SAIOP, under the supervision of a LCAS or CCS. Paraprofessional level providers may not provide services in lieu of on-site service provision by a qualified professional, LCAS, CCS, or CSAC.

The program must be under the clinical supervision of a CCS or a LCAS who is on site a minimum of 50% of the hours the service is in operation. The maximum face-to-face staff-to-client ratio is not more than 12 adult consumers to 1 QP based on an average daily attendance. The ratio for adolescents will be 1:6. Documentation must include: a daily full service note that includes the recipient's name, Medicaid identification number, date of service, purpose of contact, describes the provider's interventions, includes the time spent performing the interventions, effectiveness of the intervention, and the signature of the staff providing the service. This service must be ordered by an MD, NP, PA or PhD psychologist. Prior approval will be required via the statewide UR vendor or by an approved LME contracted with the Medicaid Agency and meeting the same standards and requirements as the statewide vendor. This initial prior approval process will ensure that the level of the service is appropriate and concurrent reviews will determine the ongoing medical necessity for the service or the need to move up or down the continuum of services to another level of care.

13. D. Diagnostic, Screening, Treatment, Preventive and Rehabilitative Services (continued)  
Description of Services

(xii) Substance Abuse Comprehensive Outpatient Treatment (SACOT)

This periodic service is a time-limited, multifaceted service approach for adults who require structure and support to achieve and sustain recovery. It emphasizes reduction in use and abuse of substances and/or continued abstinence, the negative consequences of substance abuse, development of a support network necessary to support necessary life style changes, and the continued commitment to recovery. The individual components of the services include:

- Individual counseling and support,
- Group counseling and support,
- Family counseling and support,
- Biochemical assays to identify recent drug use (e.g. urine drug screens),
- Strategies for relapse prevention to include community and social support systems in treatment,
- Crisis contingency planning,
- Disease management; and
- Treatment support activities that have been adapted or specifically designed for persons with physical disabilities, pr persons with co-occurring disorders of mental illness and substance abuse/dependence or mental retardation/developmental disabilities and substance abuse/dependence.

This service must operate at least 20 hours per week and offer a minimum of 4 hours of scheduled services per day with availability of at least 5 days per week with no more than a 2 day lapse between services. Documentation must include: a daily full service note that includes the recipient's name, Medicaid identification number, date of service, purpose of contact, describes the provider's interventions, includes the time spent performing the interventions, effectiveness of the intervention, and the signature of the staff providing the service. Staff must meet the requirements for CCS, LCAS and CSAC or a QP, AP or paraprofessional. Recipients must have ready access to psychiatric assessment and treatment services when warranted by the presence of symptoms indicating a co-occurring disorder. This service must be ordered by an MD, NP, PA or PhD psychologist. Prior approval will be required via the statewide UR vendor or by an approved LME contracted with the Medicaid Agency and meeting the same standards and requirements as the statewide vendor. This initial prior approval process will ensure that the level of the service is appropriate and concurrent reviews will determine the ongoing medical necessity for the service or the need to move up or down the continuum of services to another level of care.



13. D. Diagnostic, Screening, Treatment, Preventive and Rehabilitative Services (continued)  
Description of Services

(xiii) Substance Abuse Non-Medical Community Residential Treatment

This is a 24 hour residential recovery program professionally supervised that works intensively with adults. It is a licensed rehabilitation facility with 16 beds or less without medical nursing/monitoring, with a planned program of professionally directed evaluation, care and treatment for the restoration of functioning for persons with an addictions disorder. Programs include assessment/referral, individual and group therapy, family recovery, recovery skills training, case management, disease management, symptoms monitoring, medication monitoring and self-management of symptoms. Services in the person centered plan will be adapted to the client's developmental and cognitive level. Staff requirements are CCS, LCAS and CSAC; or a QP, AP or paraprofessional (staff definitions are included at the end of this document). Medical necessity is defined in the body of the definition and utilization review will be required. Documentation must include: a daily full service note that includes the recipient's name, Medicaid identification number, date of service, purpose of contact, describes the provider's interventions, time spent performing the intervention, effectiveness of the intervention, and the signature of the staff providing the service. This service will not be billed on the same day as any other mh/dd/sas service. Medicaid will not pay room and board; will pay only the treatment component. This service must be ordered by an MD, NP, PA or PhD psychologist. Prior approval will be required via the statewide UR vendor or by an approved LME contracted with the Medicaid Agency and meeting the same standards and requirements as the statewide vendor. This initial prior approval process will ensure that the level of the service is appropriate and concurrent reviews will determine the ongoing medical necessity for the service or the need to move up or down the continuum of services to another level of care. This is a short term service that cannot be provided for more than 30 days in a 12 month period.

13. D. Diagnostic, Screening, Treatment, Preventive and Rehabilitative Services (continued)

Description of Services

(xiv) Substance Abuse Medically Monitored Residential Treatment

This is a 24 hour non-hospital, medically monitored facility with 16 beds or less, with 24 hour medical/nursing monitoring where a planned program of professionally directed evaluation, care and treatment for the restoration of functioning for persons with alcohol and other drug problems/addictions occurs. This facility is not a detoxification facility but the focus is on treatment after detoxification has occurred.

- Non hospital rehabilitation facility,
- Assessments,
- Monitoring of patient's progress and medication administration,
- Treatment relating to restoration of functioning (sustained improvement in health and psychosocial functioning, reduction of psychiatric symptoms when present, and reduction in risk of relapse); and
- First responder for crisis intervention.

It is staffed by Certified Clinical Supervisor, Licensed Clinical Addiction Specialist and Certified Substance Abuse Counselor's, QPs, APs and paraprofessionals with training and expertise with this population. Documentation must include: a daily full service note that includes the recipient's name, Medicaid identification number, date of service, purpose of contact, describes the provider's interventions, includes the time spent performing the interventions, effectiveness of the intervention, and the signature of the staff providing the service. This service must be ordered by an MD, NP, PA or PhD psychologist. Prior approval will be required via the statewide UR vendor or by an approved LME contracted with the Medicaid Agency and meeting the same standards and requirements as the statewide vendor. This initial prior approval process will ensure that the level of the service is appropriate and concurrent reviews will determine the ongoing medical necessity for the service or the need to move up or down the continuum of services to another level of care. This is a short term service that cannot be provided for more than 30 days in a 12 month period.

13. D. Diagnostic, Screening, Treatment, Preventive and Rehabilitative Services (continued)  
Description of Services

(xv) Ambulatory Detoxification

Ambulatory detox is an organized service delivered by trained practitioners who provide medically supervised evaluations, detoxification and referral services in a licensed facility, according to a predetermined schedule. These services are provided in regularly scheduled sessions by a CCS, LCAS, QP or AP. A physician is available 24/7 to conduct an assessment within 24 hours of admission. A registered nurse is available to conduct a nursing assessment on admission and oversee the monitoring of patient's progress and medications. Documentation must include: a service note that includes the recipient's name, Medicaid identification number, date of service, purpose of contact, describes the provider's interventions, time spent performing the intervention, effectiveness of the intervention, and the signature of the staff providing the service. This service must be ordered by an MD, NP, PA or PhD psychologist. Prior approval will be required via the statewide UR vendor or by an approved LME contracted with the Medicaid Agency and meeting the same standards and requirements as the statewide vendor. This initial prior approval process will ensure that the level of the service is appropriate and concurrent reviews will determine the ongoing medical necessity for the service or the need to move up or down the continuum of services to another level of care.

13. D. Diagnostic, Screening, Treatment, Preventive and Rehabilitative Services (continued)  
Description of Services

(xvi) Non-Hospital Medical Detoxification

Medically monitored detoxification is an organized service by medical and nursing professionals that provides for 24 hour medically supervised evaluations and withdrawal management in a licensed permanent facility affiliated with a hospital or in a freestanding facility of 16 beds or less. It is staffed by CCS, LCAS, CSAC, QP, AP and paraprofessionals. A physician is available 24 hours a day by telephone and conducts an assessment within 24 hours of admission. A registered nurse is available to conduct a nursing assessment on admission and oversee the monitoring of patient's progress and medications. Specifics of clinical criteria are included in the definition. The focus of this service is detoxification. Documentation must include: a daily full service note that includes the recipient's name, Medicaid identification number, date of service, purpose of contact, describes the provider's interventions, includes the time spent performing the interventions, effectiveness of the intervention, and the signature of the staff providing the service. This service must be ordered by an MD, NP, PA or PhD psychologist. Prior approval will be required via the statewide UR vendor or by an approved LME contracted with the Medicaid Agency and meeting the same standards and requirements as the statewide vendor. This initial prior approval process will ensure that the level of the service is appropriate and concurrent reviews will determine the ongoing medical necessity for the service or the need to move up or down the continuum of services to another level of care. This is a short term service that cannot be provided for more than 30 days in a 12 month period.

13. D. Diagnostic, Screening, Treatment, Preventive and Rehabilitative Services (continued)  
Description of Services

(xvii) Medically Monitored or Alcohol Drug Addiction Treatment Center Detoxification  
(ADATC)/Crisis Stabilization

This is an organized service delivered by medical and nursing personnel that provides 24 hour medically supervised evaluation and withdrawal management in a licensed permanent facility with 16 or less beds. Services are delivered under a defined set of physician approved policies and physician monitored procedures and clinical protocols. Recipients are often in crisis due to co-occurring severe substance-related mental disorders and are in need of short term intensive evaluation, treatment intervention or behavioral management to stabilize the acute or crisis situation.

- Medically supervised evaluation and withdrawal management,
- Intensive evaluation,
- Treatment interventions,
- Behavioral management to stabilize the acute or crisis situation; and
- Established protocols are established to transfer patients, with severe biomedical conditions who are in need of medical services beyond the capacity of the facility, to the appropriate level of care.

The service has restraint and seclusion capabilities. Recipients are carefully evaluated to ensure they do not need a different level of care. A registered nurse is available to conduct a nursing assessment on admission and oversee the monitoring of patient's progress and medications on an hourly basis. Appropriately licensed and credentialed staff is available to administer medications in accordance with physician's orders. Clinical criteria (medical necessity criteria for admission and continued stay) are imbedded in the definition. Documentation must include: a daily full service note that includes the recipient's name, Medicaid identification number, date of service, purpose of contact, describes the provider's interventions, time spent performing the intervention, effectiveness of the intervention, and the signature of the staff providing the service. This service must be ordered by an MD, NP, PA or PhD psychologist. Prior approval will be required via the statewide UR vendor or by an approved LME contracted with the Medicaid Agency and meeting the same standards and requirements as the statewide vendor. This initial prior approval process will ensure that the level of the service is appropriate and concurrent reviews will determine the ongoing medical necessity for the service or the need to move up or down the continuum of services to another level of care. This is a short term service that cannot be provided for more than 30 days in a 12 month period.

13. D. Behavioral Health Rehabilitative Services (continued)  
Provider Qualifications for Staff Employed by Agencies Enrolled with Medicaid

Supervision is provided as described below:

Covered services are provided to recipients by agencies directly enrolled in the Medicaid program which employ qualified professionals, associate professional and paraprofessionals. Medically necessary services delivered by associate and paraprofessionals are delivered under the supervision and direction of the qualified professional. The qualified professional personally works with consumers to develop the person centered individualized treatment plan and meets with consumers periodically during the course of treatment to monitor the services being delivered and to review the need for continued services. The supervising qualified professional assumes professional responsibility for the services provided by associate and paraprofessionals and spends as much time as necessary directly supervising services to ensure that recipients are receiving services in a safe and efficient manner in accordance with accepted standards of practice. The terms of the qualified professional's employment with the directly enrolled agency providing service ensures that the qualified professional is adequately supervising the associate and paraprofessionals. The agencies ensure that supervisory ratios are reasonable and ethical and provide adequate opportunity for the qualified professional to effectively supervise the associate and paraprofessional staff assigned. Documentation is kept to support the supervision provided to associate and paraprofessional staff in the delivery of medically necessary services.

13. E. Behavioral Health Rehabilitative Services (continued)

Provider Qualifications for Staff Employed by Agencies Enrolled with Medicaid

Providers will meet either the appropriate Federal regulations or the requirements for one of the three categories described on pages 15a.14 and 15a.15.

- i) Paraprofessional  
“Paraprofessional” within the mental health and substance system means an individual who has a GED or high school diploma (or no GED or high school diploma if employed prior to November 1, 2001). Supervision shall be provided by a qualified professional or associate professional with the population served.
- ii) Associate Professional (AP)  
“Associate Professional” within the mental health and substance abuse services system means an individual who is a:
  - graduate of college or university with a Masters degree in a human service field and less than one year of full time post-graduate mental health or substance abuse experience with the population served or a substance abuse professional with less than one year of full-time, post-graduate degree supervised experience in alcoholism and drug abuse counseling. Supervision shall be provided by a qualified professional with the population served until the individual meets one year of experience; or
  - graduate of college or university with a bachelor’s degree in a human service field with less than two years of full-time post-bachelor’s degree mental health or substance abuse experience with the population served, or a substance abuse professional with less than two years post bachelor’s degree accumulated supervised experience in alcoholism and drug abuse counseling. Supervision shall be provided by a qualified professional with the population served until the individual meets two years of experience; or
  - graduate of a college or university with a bachelor’s degree in a field other than human services with less than four years of full-time, post bachelor’s degree accumulated supervised experience in mental health or substance abuse with the population served. Supervision shall be provided by a qualified professional with the population served until the individual meets four years of experience; or
  - registered nurse who is licensed to practice in the State of North Carolina by the North Carolina Board of Nursing with less than four years of full-time accumulated experience in mental health or substance abuse with the population served. Supervision shall be provided by a qualified professional with the population served until the individual meets four years of experience.

13. E. Behavioral Health Rehabilitative Services (continued)  
Provider Qualifications for Staff Employed by Agencies Enrolled with Medicaid

(iii) Qualified Professional (QP)

“Qualified Professional” within the mental health and substance abuse system means:

- an individual who holds a license, provisional license, certificate, registration or permit issued by the governing board regulating a human service profession, except a registered nurse who is licensed to practice in the State of North Carolina by the North Carolina Board of Nursing, who also has four years of full-time accumulated experience in mh/sa with the population served; or
- a graduate of a college or university with a Masters degree in a human service field and one year of full-time, post-graduate degree experience with the population served or a substance abuse professional with one year of full-time, post-graduate degree accumulated supervised experience in alcoholism and drug abuse counseling; or
- a graduate of college or university with a bachelor’s degree in a human service field and two years of full-time, post-bachelor’s degree experience with the population served or a substance abuse professional who has two years full-time, post-bachelor’s degree accumulated supervised alcoholism and drug abuse counseling; or
- a graduate of a college or university with a bachelor’s degree in a field other than human services with four years of full-time, post-bachelors degree accumulated mh/sa experience with the population served.

This category includes Substance Abuse Professional, Certified Substance Abuse Counselors (CSAC), Certified Clinical Supervisor (CCS), Licensed Clinical Addictions Specialist (LCAS) \*

The full descriptions of categories of providers are found in the North Carolina Administrative Code

Supervision is provided as described below:

Covered services are provided to recipients by agencies directly enrolled in the Medicaid program which employ qualified professionals, associate professional and paraprofessionals. Medically necessary services delivered by associate and paraprofessionals are delivered under the supervision and direction of the qualified professional. The qualified professional personally works with consumers to develop the person centered individualized treatment plan and meets with consumers periodically during the course of treatment to monitor the services being delivered and to review the need for continued services. The supervising qualified professional assumes professional responsibility for the services provided by associate and paraprofessionals and spends as much time as necessary directly supervising services to ensure that recipients are receiving services in a safe and efficient manner in accordance with accepted standards of practice. The terms of the qualified professional’s employment with the directly enrolled agency providing service ensures that the qualified professional is adequately supervising the associate and paraprofessionals. The agencies ensure that supervisory ratios are reasonable and ethical and provide adequate opportunity for the qualified professional to effectively supervise the associate and paraprofessional staff assigned. Documentation is kept to support the supervision provided to associate and paraprofessional staff in the delivery of medically necessary services.



State Plan Under Title XIX of the Social Security Act  
Medical Assistance Program  
State: North Carolina

---

---

13. D. Behavioral Health Rehabilitative Services (*continued*)

Provider Qualifications for Staff Employed by Agencies Enrolled with Medicaid

Services under this section are provided by licensed practitioners or programs/agencies for the mentally ill, developmentally disabled and substance abusers, certified/licensed as clinical addiction specialists (LCAS) and clinical supervisors (CCS) meeting the program standards of the Commission on Mental Health, Developmental Disabilities and Substance Abuse Services; and who are directly enrolled with Medicaid. These services are available to categorically needy and medically needy beneficiaries.

Services may be provided by:

Licensed or certified psychologists, licensed clinical social workers, licensed clinical social worker associates, certified clinical nurse specialists in psychiatric mental health advanced practice, nurse practitioners certified in psychiatric mental health advanced practice, licensed psychological associates, licensed professional counselors, licensed professional counselor associates, licensed marriage and family therapists, licensed marriage and family therapist associates, certified/licensed clinical addictions specialists, licensed clinical addictions specialist associates, and certified/licensed clinical supervisors.

For individuals under 21, the first 16 visits are unmanaged visits. Unmanaged visits are defined as services that do not require prior approval by a utilization review vendor under the fee for service delivery system. For individuals under 21, Medicaid policy does require that the child or adolescent be referred for these services through the child's Community Care of North Carolina primary care physician, a Medicaid enrolled psychiatrist or the Local Management Entity (LME). The referral is not limited to the primary care physician but does include a choice of referral sources. The referral is requested by the practitioner offering services and is indicated on the request for reimbursement. The reason for the requirement for a referral for children and adolescents is to promote coordination of care including medical and behavioral health services when indicated for this population.

For individuals 21 years and older, the first 8 visits are unmanaged visits. Unmanaged visits are defined as services that do not require prior approval by a utilization review vendor under the fee for service delivery system. Medicaid eligible adults (21 years and older) may be self-referred.

State Plan Under Title XIX of the Social Security Act  
Medical Assistance Program  
State: North Carolina

---

---

13. D. Behavioral Health Rehabilitative Services (*continued*)

Provider Qualifications for Staff Employed by Agencies Enrolled with Medicaid

Services include the following:

1. Outpatient Psychotherapy services are individual psychotherapy, family psychotherapy; and group psychotherapy. Psychotherapy, as defined in the current American Medical Association's Current Procedural Terminology (CPT) Manual is the treatment for mental illness as well as substance use disorders in which the clinician through therapeutic communication attempts to alleviate the emotional disturbances and reverse or change maladaptive patterns of behavior. Individual psychotherapy is psychotherapy provided with the licensed clinician and the recipient on a one to one face-to-face basis. Family psychotherapy is psychotherapy provided with the licensed clinician and one or more family members face-to-face. Group psychotherapy is psychotherapy provided with the licensed clinician and more than one recipient face to face. Psychotherapy services may be provided in a variety of settings and psychotherapy may be practiced utilizing a variety of models many of whom have significant evidence backing their efficacy. These models include Behavior Therapy, Cognitive Therapy, Psychodynamic Therapy, Cognitive Behavioral Therapy, and Person-Centered Therapy. Cognitive Therapy is a treatment model that focuses on challenging and changing distorted thinking in order to regain and restore the beneficiary's level of social and emotional functioning and engagement in the community. Psychodynamic Therapy is a treatment model that assumes dysfunctional behavior is caused by unconscious internal conflicts. The focus of treatment is to gain insight into unconscious motives of behavior in order to regain and restore the beneficiary's level of social and emotional functioning and engagement in the community. Cognitive Behavioral Therapy is a treatment model that assumes that maladaptive thinking patterns cause maladaptive behavior as well as negative emotions. The treatment focuses on changing the recipient's thoughts in order to change behavior as well as emotions in order to regain and restore the beneficiary's level of social and emotional functioning and engagement in the community. Person-Centered Therapy is a nondirective treatment model in which the clinician helps the beneficiary increase understanding and awareness of attitudes, feelings, and behavior, in order to regain and restore the beneficiary's level of social and emotional functioning and engagement in the community.

State Plan Under Title XIX of the Social Security Act  
Medical Assistance Program  
State: North Carolina

---

13. D. Behavioral Health Rehabilitative Services (*continued*)

Provider Qualifications for Staff Employed by Agencies Enrolled with Medicaid

All psychotherapy services are only for the benefit of Medicaid recipients. These services can be furnished by all the North Carolina licensed and certified clinicians listed below. These North Carolina licensed and certified clinicians are: licensed-psychologists, licensed clinical social workers, certified clinical nurse specialists in psychiatric mental health advanced practice, nurse practitioners certified in psychiatric mental health advanced practice, licensed psychological associates, licensed professional counselors, licensed marriage and family therapists, licensed clinical addictions specialists, and certified clinical supervisors. Each of the above listed clinicians is licensed by their respective occupational licensing board and is credentialed to practice independently and it is within their scope of practice to provide individual psychotherapy, family psychotherapy, and group psychotherapy.

2. Psychological testing (e.g., Minnesota Multiphasic Personality Inventory, Rorschach, and Wechsler Adult Intelligence Scale) includes written, visual, or verbal evaluations administered to assess the cognitive and emotional functioning of recipients. Developmental testing (e.g., Developmental Screening Test, Bayley Scales of Infant and Toddler Development, Mullen Scales of Early Learning) includes assessment of motor, language, social, adaptive and/or cognitive functioning by standardized developmental instruments. Neuro-behavioral testing (e.g., Halstead-Reitan, Wechsler Memory Scales, and Wisconsin Card Sorting Test) includes standard tests designed to evaluate different aspects of the functioning of the central nervous system, including attention, motor performance, perceptual coding, learning, memory and affect.

These services can only be furnished by PhD and Master's Level Psychologist, licensed in the State of North Carolina." These individuals have, within the scope of their practice, the ability to perform psychological testing, developmental testing, and neurobehavioral testing. However, each individual psychologist must also have the training and experience required in order to ethically provide each of these assessments according to the requirements of the North Carolina Psychology Board.

State Plan Under Title XIX of the Social Security Act  
Medical Assistance Program  
State: North Carolina

---

13. D. Behavioral Health Rehabilitative Services (*continued*)

Provider Qualifications for Staff Employed by Agencies Enrolled with Medicaid

Psychological testing, developmental testing, and neuro-behavioral testing should result in recommendations regarding the need for rehabilitative treatment which may include outpatient services and should result in recommendations for type, duration, frequency, or amount of rehabilitative services.

- B. All disciplines are licensed or credentialed by the State as mental health clinicians and can practice independently with oversight by their individual boards. Nurse Practitioners must have oversight by the Medical Board, while Licensed Psychological Associates must have supervision by a PhD to bill certain services. This type of requirement does not exist for the other disciplines.

Certified/Licensed Clinical Supervisors (CCS) and Certified/Licensed Clinical Addictions Specialists (CCAS) requirements have been approved by the Division of Mental Health/Developmental Disabilities/Substance Abuse Services and are able to practice independently to provide counseling services only.

- C. Behavioral assessment and counseling codes may be furnished and billed by all clinicians. CPT codes or counseling codes should be used to define services provided not based on discipline.

- C. High Risk Intervention services for EPSDT eligible children are provided under this section. The services comprise a treatment component package, which may be provided in supervised residential settings. A physician or a Ph.D. psychologist orders these services. A treatment plan must be in place. The population served is for children under 21 years of age that have mental health or substance abuse service needs. This service would only be provided for the developmentally disabled population less than 21 years of age if they have a dual diagnosis, MR along with MI or SA, and medical necessary services are needed for MI/SA. The CFR reference is CFR 42 440. 130. The residential living situation is not compensated for room and board.

High Risk Intervention services has four levels of care.

#### Level I

Level I is a low to moderate structured and supervised environment level of care provided in a family setting. Services provided include: mentoring, minimal staff/support/supervision in all identified need areas, minimal assistance with adaptive skill training in all functional domains, behavioral interventions for mildly disruptive behaviors, minimal assistance with community integration activities, and stress management. Modeling, providing positive reinforcement when needed, teaching social skills, daily living skills, anger management, family living skills and communication skills are all part of the treatment component.

#### Level II

Level II is a moderate to high structured supervised environment level of care provided in a group home (a minimum of one staff is required per four consumers at all times) or a family setting (one or two consumers per home). This service in the family or program settings includes all of Level I elements plus provision of a more intensive corrective relationship in which therapeutic interactions are dominant. There is a higher level of supervision and structure. Provider requirements for Program Type Residential Treatment is a high school education/GED or an associate degree with one year experience; or a four-year degree in the human service field; and / or must meet requirements established by the state personnel system or equivalent for job classifications.

Skills and competencies of this service provider must be at a level, which offer psychoeducational relational support, behavioral modeling interventions and supervision. Additionally, special training of the caregiver is required in all aspects of sex offender specific treatment. A qualified professional is also available oncall. Implementation of therapeutic gains is to be the goal of the placement setting.

### Level III

Level III is a highly structured and supervised environment level of care in a program setting only. All elements of Family/Program-Type Residential Treatment (Levels I, II) are provided plus intensified structure, supervision, and containment of frequent and highly inappropriate behavior. This setting is typically defined as being “staff secure”. Staff is present and available at all times of the day, including overnight awake.

A minimum of one staff is required per four consumers at all times. Staffing requirements are: minimal requirement is a high school diploma/GED, associate degree with one year experience; or a four-year degree in the human service field and / or a combination of experience, skills, and competencies that is equivalent. Skills and competencies of this service provider must be at a level which offer psychoeducational relational support, and behavioral modeling interventions and supervision and / or must meet requirements established by the state personnel system or equivalent for job classifications. These preplanned, therapeutically structured interventions occur as required in all aspects of sex offender specific treatment. Implementation of therapeutic gains is to be the goal of the placement setting. Additionally, consultative and treatment services at a Qualified Professional level shall be available no less than four hours per week. This staff may include a social worker, psychologist, or a psychiatrist. These services must be provided at the facility.

### Level IV

Level IV is a level of care provided in a physically secure, locked environment in a program setting. All elements of Level III care are included in Level IV plus ability to manage intensive levels of aggressiveness. Supervision is continuous. Staff is present and available at all times of the day, including overnight awake. A minimum of two direct care staff are required per six consumers at all times. Additionally, consultative and treatment services at a Qualified Professional level shall be available no less than eight hours per week. Staffing provisions apply as with Level III. Provider requirements are as follows: minimal requirement is a high school diploma / GED, associate degree with one year experience or a four-year degree in the human service field and / or a combination of experience, skills and competencies that is equivalent.

Skills and competencies of this service provider must be at a level that include structured interventions in a contained setting to assist the consumer in acquiring control over acute behaviors. In addition, special training of the caregiver is required in all aspects of sex offender specific treatment; and /or the provider must meet requirements established by the state personnel system or the equivalent for job classifications. Implementation of therapeutic gains is to be the goal of the placement setting.

14.b Services for Individuals Age 65 or Older in Institutions for  
Mental Disease

(1) Inpatient Hospital Services

The state agency may grant a maximum of three administrative days to arrange for discharge of a patient to a lower level-of-care. With prior approval by the State Medicaid Agency, the hospital may be reimbursed for days in excess of the three administrative days at the statewide average rate for the particular level-of-care needed in the event a lower level-of-care bed in a Medicaid approved health care institution is not available. The hospital must, however, make every effort to place the

recipient in an appropriate institution within the three day administrative time allowance.

(3) Intermediate care facility services.

(a) Prior approval is required in the following circumstances:

- (1) All admissions to intermediate care facilities.
- (2) All utilization Review Committee recommendations that require change in the level of care; however, these recommendations will be taken into consideration at the time of review.
- (3) Patients seeking Title XIX assistance in an intermediate care facility who were previously private pay or insured by a third party carrier.
- (4) When a patient is discharged from an intermediate care facility to a lower level of care or to his own home, and later returns to a level of care that requires prior approval.
- (5) When a Medicaid patient's benefits are terminated for 90 days or more before reinstatement, even though the patient remains in the same facility.

(b) Circumstances that DO NOT Require Prior Approval for Intermediate Care:

- (1) An approved patient who is hospitalized and returns to the previously approved level of care.
- (2) An approved ICF patient who leaves the facility for an overnight stay provided the absence is authorized by the attending physician.
- (3) The Independent Professional Review Team recommends a change in level of care. These recommendations will be accepted.



- (c) The form approved for ICF placement is valid for 60 days. If a patient has not been placed during this period of validity, the state or its designated agency should be contacted. At this time, the reviewing nurse will re-evaluate the form and determine if more current information is needed.

15. Intermediate Care Facility Services

Limitations and prior approval same as described in Item 14.b.(3).

- a. Intermediate Care Services Including Such Services in a Public Institution for the Mentally Retarded

Limitations and prior approval same as described in Item 14.b.(3).

16. Inpatient Psychiatric Facility Services for Individuals Under 21

The state agency may grant a maximum of three administrative days to arrange for discharge of a patient to a lower level-of-care. With prior approval by the State Medicaid Agency, the hospital may be reimbursed for days in excess of the three administrative days at the statewide average rate for the particular level of care needed in the event a lower level-of-care bed in a Medicaid approved health care institution is not available. The hospital must, however, make every effort to place the recipient in an appropriate institution within the three day administrative time allowance.

Admissions for all out of state psychiatric hospitals including those enrolled as border psychiatric hospitals are subject to prior approval for necessity to go out of state. Services in out-of-state hospitals are provided only to the same extent and under the same conditions as medical services provided in North Carolina.

23.a. Transportation

Services provided by an ambulance provider under the Medicaid program must be demonstrated to be medically necessary and are subject to limitations described herein. Medical necessity is indicated when the patient's condition is such that any other means of transportation would endanger the patient's health. Ambulance transportation is not considered medically necessary when any other means of transportation can be safely utilized.

- a. Emergency ambulance transportation for the client to receive immediate and prompt medical services arising in an emergency situation. Emergency transportation to a physician's office is covered only if all the following conditions are met:
  - (1) The patient is enroute to a hospital.
  - (2) There is medical need for a professional to stabilize the patient's condition.
  - (3) The ambulance continues the trip to the hospital immediately after stabilization.
- b. Non-emergency ambulance transportation to and from a physician directed office/clinic or other medical facility in which the individual is an inpatient is covered in the following situations:
  - (1) Medical necessity is indicated when the use of other means of transportation is medically contraindicated because it would endanger the patient's health. This refers to clients whose medical condition requires transport by stretcher.
  - (2) Client is in need of medical services that cannot be provided in the place of residence.
  - (3) Return transportation from a facility which has capability of providing total care for every aspect of injury/disease to a facility which has fewer resources to offer highly specialized care.
- c. In order to claim Medicaid reimbursement, providers of ambulance services must be able to document that ambulance services were medically necessary.
  - (1) The UB-92 claim form must describe the recipient's medical condition at the time of transport by using appropriate condition codes to demonstrate that transportation by any other means would be medically inappropriate.
  - (2) A legible copy of the ambulance call report to support the condition codes used must be kept on file by the provider for five (5) years which indicates:
    - a. the purpose for transport,
    - b. the treatments,
    - c. the patient's response; and
    - d. the patient's condition that sufficiently justifies transport by stretcher was medically necessary.
- d. Prior approval is required for non-emergency transportation for recipients to receive out-of-state services or to return to North Carolina or nearest appropriate facility.

23.d. Skilled Nursing Facility Services for Patients Under 21 Years of Age

Limitations and prior approval same as described in Item 4.a. Skilled Nursing Facility Services.

**State Plan Under Title XIX of the Social Security Act  
Medical Assistance Program  
State: NORTH CAROLINA**

---

**24f. Personal Care Services:**

**SERVICES**

Personal care services (PCS) include a range of human assistance provided to persons of all ages with disabilities and chronic conditions to enable them to accomplish tasks that they would ordinarily do for themselves if they were not disabled. These PCS are intended to provide person-to-person, hands-on assistance by a PCS direct care worker in the beneficiary's home or residential setting with common activities of daily living (ADLs) that, for this program are eating, dressing, bathing, toileting, and mobility. PCS also include: assistance with instrumental activities of daily living (IADLs), such as light housekeeping tasks, when directly related to the approved ADLs and the assistance is specified in the beneficiary's plan of care. PCS is provided by a direct care worker who is employed by a licensed home care agency, or by a residential facility licensed as an adult care home, family care home, supervised living facility, or combination home, and who meets the qualifications specified on Attachment 3.1-A.1, Pages 23-29, section c.

In addition to the specified assistance with ADLs and IADLs, qualified PCS direct care workers may also provide Nurse Aide I and Nurse Aide II tasks as specified on Attachment 3.1-A.1, Pages 23-29, section c., pursuant to the North Carolina Board of Nursing as described in 21 NCAC 36.0403 and as specified in the beneficiary's approved plan of care.

**ELIGIBILITY**

**To qualify for PCS, an adult or child must:**

- Be referred for PCS by his or her primary care or attending physician;
- Be medically stable;
- Not require monitoring, (observation resulting in intervention), supervision (precautional observation) or ongoing care from a licensed health care professional; and

**Require hands-on assistance with at least:**

- a. Three of the five qualifying ADLs at the limited level; or
- b. Two of the five qualifying ADLs, one of which is at the extensive level; or
- c. Two of the five qualifying ADLs, one of which is at the full dependency level.

Recipients not qualifying for additional PCS hours under EPSDT may qualify for up to 50 additional hours of Medicaid PCS assistance by a physician attestation that the Medicaid recipients meets the eligibility criteria provided in Session Law 203-306, Section 10.99F.(c)(3) and (a-d) below:

**State Plan Under Title XIX of the Social Security Act  
Medical Assistance Program  
State: NORTH CAROLINA**

---

24f. **Personal Care Services (continued):**

- (a) Requires an increased level of supervision (precautional observation) as assessed during an independent assessment conducted by State Medicaid Agency or entity designated by State Medicaid Agency;
- (b) Requires caregivers with training or experience in caring for individuals who have a degenerative disease characterized by irreversible memory dysfunction, that attacks the brain and results in impaired memory, thinking, and behavior, including gradual memory loss, impaired judgment, disorientation, personality change, difficulty learning, and the loss of language skills;
- (c) Regardless of setting, requires a physical environment that addresses safety and safeguards the beneficiary because of the recipient's gradual memory loss, impaired judgment, disorientation, personality change, difficulty learning, and loss of language skill; and
- (d) Medical documentation or verifiable information provided by a caregiver obtained during the independent assessment reflects a history of escalating safety concerns related to inappropriate wandering, ingestion, aggressive behavior, and an increased incidence of falls.

Each ADL is scored at one of five levels of self-performance or assistance. Totally Able and Cueing/Supervision levels of need do not entail hands-on assistance and are not qualifying levels of need for PCS. The three qualifying levels of need are Limited Hands-On Assistance, Extensive Hands-On Assistance, and Full Dependence.

**The five levels of need are defined as follows:**

- Totally Able- Beneficiary is able to self-perform 100 percent of activity, with or without aides or assistive devices, and without supervision or assistance setting up supplies and environment.
- Cueing/Supervision- Beneficiary is able to self-perform 100 percent of activity, with or without aides or assistive devices, and requires supervision, monitoring, or assistance retrieving or setting up supplies or equipment.
- Limited Hands-On Assistance- Beneficiary is able to self-perform more than 50 percent of activity and requires hands-on assistance to complete remainder of activity.
- Extensive Hands-On Assistance- Beneficiary is able to self-perform less than 50 percent of activity and requires hands-on assistance to complete remainder of activity.
- Full Dependence- Beneficiary is unable to perform any of the activity and is totally dependent on another to perform all of the activity.

**State Plan Under Title XIX of the Social Security Act  
Medical Assistance Program  
State: NORTH CAROLINA**

---

**24f. Personal Care Services (continued):**

**Service Limitations:**

1. Up to 130 hours per month for adults,
2. Up to 60 hours per month for children. Pursuant to section 1905(r)(5) of the Social Security Act, the Early and Periodic Screening, Diagnostic and Treatment (EPSDT) benefit requires that states provide all medically necessary services coverable under the Medicaid program to EPSDT eligible children. Hours above the 60 hours may be provided to children through the EPSDT allowance; and
  - Services levels must be re-assessed and re-authorized at least annually.

**Service Exclusions:**

- a. Services provided in an unauthorized location;
- b. Services provided by unauthorized individuals or providers;
- c. The beneficiaries primary need is housekeeping or homemaking;
- d. The IADLs performed are not directly related to the approved ADLs or as specified in the beneficiaries plan of care;
- e. In the event that the services provided in a month exceed a beneficiary's authorized monthly limit, services that exceed the authorized level will not be reimbursed;
- f. The services provided are not in accordance with the person-centered plan of care;
- g. Companion sitting or leisure time activities;

State Plan Under Title XIX of the Social Security Act

Medical Assistance Program

State: NORTH CAROLINA

- 
1. Continuous monitoring or ongoing beneficiary supervision except when approved under the EPSDT program based on a determination of medical necessity;
  2. Financial management;
  3. Errands; and
  4. Personal care or home management tasks for other residents of the household

North Carolina assures that personal care services do not include, and FFP is not available for, services to individuals residing in institutions for mental disease (IMD).

**State Plan Under Title XIX of the Social Security Act  
Medical Assistance Program  
State: NORTH CAROLINA**

---

24f. **Personal Care Services (cont.):**

**PERSONAL CARE SERVICES (PCS) AGENCY/ENTITY AND DIRECT CARE WORKER  
QUALIFICATIONS**

- a. **Each PCS agency/entity must be enrolled with NC Medicaid.**
- b. To ensure that the PCS direct care workers are properly supervised, and that PCS services are available in a range of settings, and not as a limitation on the availability of services; PCS Agency/Entity providers are required to perform the following activities to comply with state laws and rules:
  - 1. Complete background checks on all employees;
  - 2. Conduct trainings;
  - 3. Monitor quality of care;
  - 4. Develop a beneficiary plan of care; and
  - 5. Ensure that PCS direct care workers work under ~~the~~ supervision as specified in licensure requirements;

PCS agency/entity and direct care worker qualifications continue on Attachment 3.1-A.1, Pages 23-29.



**State Plan Under Title XIX of the Social Security Act  
Medical Assistance Program  
State: NORTH CAROLINA**

**PERSONAL CARE SERVICES (PCS) AGENCY /ENTITY & DIRECT CARE WORKER QUALIFICATIONS (continued)**

c. PCS agency/entity provider definitions and direct care worker minimum qualifications, minimum training requirements, and additional staffing requirements are as follows:

	<b>AGENCY/ENTITY PROVIDER</b>				
	<b>ADULT CARE HOME</b>	<b>FAMILY CARE HOME</b>	<b>COMBINATION HOME</b>	<b>SUPERVISED LIVING</b>	<b>HOME CARE AGENCIES</b>
<b>Agency/Entity Provider Definitions</b>	Adult Care Homes licensed as a residential facility as defined under 131D-2 101 (1a) and licensed by the State of North Carolina as an adult care home or family care home or; a combination home as defined in G.S. 131E-101(1a).	Adult care homes that provide care to two to six unrelated residents are commonly called family care homes. G.S. 131D-2.1	In accordance to G.S. 131E-101, a combination home, as distinguished from a nursing home, means a facility operated in part as a nursing home, and which also provides residential care for aged or disabled persons whose principal need is a home with the shelter or personal care their age or disability requires. Services to the resident in an adult care home bed within the combination home are distinct from NF beds	A group home licensed under G.S. 122C and under 10A NCAC 27G .5601 as a supervised living facility for two or more adults whose primary diagnosis is mental illness, a developmental disability, or substance abuse dependency	Home care agencies as defined under G.S. 131E-136 (2) and licensed by the State of North Carolina as a home care agency under 10A NCAC 13J;"Home care agency" means a private or public organization that provides home care services.

State Plan Under Title XIX of the Social Security Act  
Medical Assistance Program  
State: NORTH CAROLINA

PERSONAL CARE SERVICES (PCS) AGENCY /ENTITY & DIRECT CARE WORKER QUALIFICATIONS (continued)

	AGENCY/ENTITY PROVIDER				
	ADULT CARE HOME	FAMILY CARE HOME	COMBINATION HOME	SUPERVISED LIVING	HOME CARE AGENCIES
			in that services do not meet the NF level of care criteria, MDS process is not used, cannot be billed at the NF case rate, and any medical care is incidental. An adult care home bed in a combination home provides the residential care to aged or disabled who demonstrate unmet needs for personal care. While medical care is incidental services center on unmet activities of daily living such as assistance with bathing, dressing, toileting, ambulation, and eating.		
<b>Direct Care Worker Minimum Qualifications</b>	18 years of age or; high school graduates or equivalent	18 years of age or; high school graduates or equivalent	18 years of age or; high school graduates or equivalent	18 years of age or; high school graduates or equivalent	18 years of age or; high school graduates or equivalent
PCS Direct Care Worker_Minimal Training Requirements	1) Beneficiary rights; 2) Confidentiality and Privacy Practices; 3) Personal Care Skills a) Assistance with Bathing b) Assistance with Toileting	1) Beneficiary rights; 2) Confidentiality and Privacy Practices; 3) Personal Care Skills a) Assistance with Bathing b) Assistance with Toileting	1) Beneficiary rights; 2) Confidentiality and Privacy Practices; 3) Personal Care Skills a) Assistance with Bathing b) Assistance with Toileting	1) Beneficiary rights; 2) Confidentiality and Privacy Practices; 3) Personal Care Skills a) Assistance with Bathing b) Assistance with Toileting	1) Beneficiary rights; 2) Confidentiality and Privacy Practices; 3) Personal Care Skills a) Assistance with Bathing b) Assistance with Toileting

TN No. 12-013  
Supersedes  
TN. No. 12-005

Approved Date: 11-30-12

Eff. Date: 01/01/2013

**State Plan Under Title XIX of the Social Security Act  
Medical Assistance Program  
State: NORTH CAROLINA**

**PERSONAL CARE SERVICES (PCS) AGENCY /ENTITY & DIRECT CARE WORKER QUALIFICATIONS (continued)**

	AGENCY/ENTITY PROVIDER				
	ADULT CARE HOME	FAMILY CARE HOME	COMBINATION HOME	SUPERVISED LIVING	HOME CARE AGENCIES
	<ul style="list-style-type: none"> <li>c) Assistance with Mobility</li> <li>d) Assistance with Dressing</li> <li>e) Assistance with Eating</li> <li>4) Training about providing care to individuals with impaired judgment, disorientation, loss of language skills, inappropriate behaviors, like wandering that are resulting from the exacerbation of dementia</li> <li>5) Documentation and Reporting of beneficiary accidents and incidents;</li> <li>6) Recognizing and Reporting Signs of Abuse and Neglect;</li> <li>7) Infection Control</li> </ul>	<ul style="list-style-type: none"> <li>c) Assistance with Mobility</li> <li>d) Assistance with Dressing</li> <li>e) Assistance with Eating</li> <li>4) Training about providing care to individuals with impaired judgment, disorientation, loss of language skills, inappropriate behaviors, like wandering that are resulting from the exacerbation of dementia</li> <li>5) Documentation and Reporting of beneficiary accidents and incidents;</li> <li>6) Recognizing and Reporting Signs of Abuse and Neglect;</li> <li>7) Infection Control</li> </ul>	<ul style="list-style-type: none"> <li>c) Assistance with Mobility</li> <li>d) Assistance with Dressing</li> <li>e) Assistance with Eating</li> <li>4) Training about providing care to individuals with impaired judgment, disorientation, loss of language skills, inappropriate behaviors, like wandering that are resulting from the exacerbation of dementia</li> <li>5) Documentation and Reporting of beneficiary accidents and incidents;</li> <li>6) Recognizing and Reporting Signs of Abuse and Neglect;</li> <li>7) Infection Control</li> </ul>	<ul style="list-style-type: none"> <li>c) Assistance with Mobility</li> <li>d) Assistance with Dressing</li> <li>e) Assistance with Eating</li> <li>4) Training about providing care to individuals with impaired judgment, disorientation, loss of language skills, inappropriate behaviors, like wandering that are resulting from the exacerbation of dementia</li> <li>5) Documentation and Reporting of beneficiary accidents and incidents;</li> <li>6) Recognizing and Reporting Signs of Abuse and Neglect;</li> <li>7) Infection Control</li> </ul>	<ul style="list-style-type: none"> <li>b) Assistance with Mobility</li> <li>c) Assistance with Dressing</li> <li>d) Assistance with Eating</li> <li>4) Training about providing care to individuals with impaired judgment, disorientation, loss of language skills, inappropriate behaviors, like wandering that are resulting from the exacerbation of dementia</li> <li>5) Documentation and Reporting of beneficiary accidents and incidents;</li> <li>6) Recognizing and Reporting Signs of Abuse and Neglect;</li> <li>7) Infection Control</li> </ul>

TN No. 13-009  
Supersedes  
TN. No. 12-013

Approved Date: 05-19-14

Eff. Date: 10/01/2013

State Plan Under Title XIX of the Social Security Act  
Medical Assistance Program  
State: NORTH CAROLINA

PERSONAL CARE SERVICES (PCS) AGENCY /ENTITY & DIRECT CARE WORKER QUALIFICATIONS (continued)

	AGENCY/ENTITY PROVIDER				
	ADULT CARE HOME	FAMILY CARE HOME	COMBINATION HOME	SUPERVISED LIVING	HOME CARE AGENCIES
<b>Additional Staffing Qualifications</b>	<p><b>1. Personal Care Aide:</b> Personal Care Aides providing services in the Adult Care Home must meet the staff orientation, training, competency, and continuing education requirements specified in licensure requirements, including successful completion of an 80-hour personal care training and competency evaluation program established by DHHS. The training must be successfully completed within six months of hiring.</p>	<p><b>1. Personal Care Aide:</b> Personal Care Aides providing services in the Adult Care Home must meet the staff orientation, training, competency, and continuing education requirements specified in licensure requirements, including successful completion of an 80-hour personal care training and competency evaluation program established by DHHS. The training must be successfully completed within six months of hiring.</p>	<p><b>1. Personal Care Aide:</b> Personal Care Aides providing services in the Adult Care Home must meet the staff orientation, training, competency, and continuing education requirements specified in licensure requirements, including successful completion of an 80-hour personal care training and competency evaluation program established by DHHS. The training must be successfully completed within six months of hiring.</p>	<p><b>1. Paraprofessionals:</b> Staff must meet the requirements for paraprofessionals in 10A NCAC 27G.0200. Staff must have a high school diploma or GED. Staff must meet participant specific competencies as identified by the participant's person-centered planning team and documented in the Person Centered Plan. Staff must successfully complete First Aid, CPR and DMH/DD/SAS Core Competencies and</p>	<p><b>1. Personal Care Aides:</b> Personal Care Aides providing services <b>for</b> the Home Care Agencies must meet the staff orientation, training, competency, and continuing education requirements specified in licensure requirements. <b>Home Care Agency: 10A NCAC 13J</b> <a href="http://www.ncdhhs.gov/dhsr/ahc/rules.html">http://www.ncdhhs.gov/dhsr/ahc/rules.html</a> In-home aides shall follow instructions for client care written by the health care practitioner required for the services provided. In-home aide duties may help with prescribed exercises which the client and in-home aides have been taught by a health care practitioner licensed pursuant to G.S. 90; provide or assist with personal care (i.e., bathing, care of mouth, skin and hair); assist with ambulation; assist client with self-administration of medications which are ordered by a physician or other person authorized by state law to prescribe; perform incidental household services which are essential to the client's care at home; and record and report changes in the client's condition, family situation or needs to an appropriate health care practitioner.</p>

TN No. 13-009  
Supersedes  
TN. No. 12-013

Approved Date: 05-19-14

Eff. Date: 10/01/2013

**State Plan Under Title XIX of the Social Security Act  
Medical Assistance Program  
State: NORTH CAROLINA**

**PERSONAL CARE SERVICES (PCS) AGENCY /ENTITY & DIRECT CARE WORKER QUALIFICATIONS (continued)**

AGENCY/ENTITY PROVIDER				
ADULT CARE HOME	FAMILY CARE HOME	COMBINATION HOME	SUPERVISED LIVING	HOME CARE AGENCIES
2. Nurse Aide I: Nurse Aides at this level are listed on the North Carolina Nurse Aide Registry and perform basic nursing skills and personal care activities. Nurse Aide I activities are delegated by a licensed nurse based on	2. Nurse Aide I: Nurse Aides at this level are listed on the North Carolina Nurse Aide Registry and perform basic nursing skills and personal care activities. Nurse Aide I activities are delegated by a licensed nurse based on the knowledge, skill,	2. Nurse Aide I: Nurse Aides at this level are listed on the North Carolina Nurse Aide Registry and perform basic nursing skills and personal care activities. Nurse Aide I activities are delegated by a	required refresher training. Paraprofessionals providing this service must be supervised by a Qualified Professional. Supervision must be provided according to supervision requirements specified in 10A NCAC 27G.0204 and according to licensure or certification requirements of the appropriate discipline. Must have a criminal record check A healthcare registry check is required in accordance with 10A NCAC 27G.0200	2. Nurse Aide I: Nurse Aides at this level are listed on the North Carolina Nurse Aide Registry and perform basic nursing skills and personal care activities. Nurse Aide I activities are delegated by a licensed nurse based on the knowledge, skill, training, and competence of the individual aide. Nurse Aides at this level must successfully complete an orientation program specific to the employing facility, and must successfully complete a training and competency evaluation approved by DHHS. The training and competency evaluation program must be successfully completed within four months of the employment date. During the four month

TN No. 13-009  
Supersedes  
TN. No. 12-013

Approved Date: 05-19-14

Eff. Date: 10/01/2013

**State Plan Under Title XIX of the Social Security Act  
Medical Assistance Program  
State: NORTH CAROLINA**

**PERSONAL CARE SERVICES (PCS) AGENCY /ENTITY & DIRECT CARE WORKER QUALIFICATIONS (continued)**

	<b>AGENCY/ENTITY PROVIDER</b>				
	<b>ADULT CARE HOME</b>	<b>FAMILY CARE HOME</b>	<b>COMBINATION HOME</b>	<b>SUPERVISED LIVING</b>	<b>HOME CARE AGENCIES</b>
	the knowledge, skill, training, and competence of the individual aide. Nurse Aides at this level must successfully complete an orientation program specific to the employing facility, and must successfully complete a training and competency evaluation approved by DHHS. The training and competency evaluation program must be successfully completed within four months of	training, and competence of the individual aide. Nurse Aides at this level must successfully complete an orientation program specific to the employing facility, and must successfully complete a training and competency evaluation	licensed nurse based on the knowledge, skill, training, and competence of the individual aide. Nurse Aides at this level must successfully complete an orientation program specific to the employing facility, and must successfully complete a training and competency evaluation		period, the individual is assigned, and performs under supervision, only tasks for which he or she has demonstrated competence.

TN No. 12-013  
Supersedes  
TN. No. NEW

Approved Date: 11-30-12

Eff. Date: 01/01/2013

**State Plan Under Title XIX of the Social Security Act  
Medical Assistance Program  
State: NORTH CAROLINA**

**PERSONAL CARE SERVICES (PCS) AGENCY /ENTITY & DIRECT CARE WORKER QUALIFICATIONS (continued)**

	AGENCY/ENTITY PROVIDER				
	ADULT CARE HOME	FAMILY CARE HOME	COMBINATION HOME	SUPERVISED LIVING	HOME CARE AGENCIES
	the employment date. During the four month period, the individual is assigned, and performs under supervision, only tasks for which he or she has demonstrated competence.	approved by DHHS. The training and competency evaluation program must be successfully completed within four months of the employment date. During the four month period, the individual is assigned, and performs under supervision, only tasks for which he or she has demonstrated competence.	approved by DHHS. The training and competency evaluation program must be successfully completed within four months of the employment date. During the four month period, the individual is assigned, and performs under supervision, only tasks for which he or she has demonstrated competence.		

TN No. 12-013  
Supersedes  
TN. No. NEW

Approved Date: 11-30-12

Eff. Date: 01/01/2013

**State Plan Under Title XIX of the Social Security Act  
Medical Assistance Program  
State: NORTH CAROLINA**

**PERSONAL CARE SERVICES (PCS) AGENCY /ENTITY & DIRECT CARE WORKER QUALIFICATIONS (continued)**

	AGENCY/ENTITY PROVIDER				
	ADULT CARE HOME	FAMILY CARE HOME	COMBINATION HOME	SUPERVISED LIVING	HOME CARE AGENCIES
	<p><b>3. Nurse Aide II:</b> Nurse Aides at this level are authorized to perform more complex nursing skills with emphasis on sterile technique in elimination, oxygenation, and nutrition, after successful completion of state-approved Nurse Aide II training program and competency evaluation program.</p>	<p><b>3. Nurse Aide II:</b> Nurse Aides at this level are authorized to perform more complex nursing skills with emphasis on sterile technique in elimination, oxygenation, and nutrition, after successful completion of state-approved Nurse Aide II training program and competency evaluation program.</p>	<p><b>3. Nurse Aide II:</b> Nurse Aides at this level are authorized to perform more complex nursing skills with emphasis on sterile technique in elimination, oxygenation, and nutrition, after successful completion of state-approved Nurse Aide II training program and competency evaluation program.</p>	<p><b>3. Nurse Aide II:</b> Nurse Aides at this level are authorized to perform more complex nursing skills with emphasis on sterile technique in elimination, oxygenation, and nutrition, after successful completion of state-approved Nurse Aide II training program and competency evaluation program.</p>	<p><b>3. Nurse Aide II:</b> Nurse Aides at this level are authorized to perform more complex nursing skills with emphasis on sterile technique in elimination, oxygenation, and nutrition, after successful completion of state-approved Nurse Aide II training program and competency evaluation program.</p>



State/Territory: North Carolina

AMOUNT, DURATION AND SCOPE OF SERVICES PROVIDED  
MEDICALLY NEEDY GROUP(S): All

---

The following ambulatory services are provided.

- (a) Chiropractic services
- (b) Dental services
- (c) Drugs, legend and insulin
- (d) EPSDT
- (e) Eyeglasses and visual aids
- (f) Family planning services
- (g) Hearing aids
- (h) Optometric services
- (i) Podiatry services
- (j) Outpatient hospital
- (k) Physician office visits
- (l) Rural health clinics
- (m) Free standing ambulatory surgical centers

Rural Health Clinic services are subject to limitations of the Physician's services program.

Other ambulatory services are subject to the limitations of each specific service program.

\*Description provided on attachment.

State/Territory: North Carolina

AMOUNT, DURATION, AND SCOPE OF SERVICES PROVIDED  
MEDICALLY NEEDY GROUP(S): \_\_\_\_\_

---

1. Inpatient hospital services other than those provided in an institution for mental diseases.  
X Provided:    No Limitations X With Limitations\*
- 2.a. Outpatient hospital services.  
X Provided:    No Limitations X With Limitations\*
- b. Rural health clinic services and other ambulatory services furnished by a rural health clinic (which are otherwise covered under the Plan)  
X Provided:    No Limitations X With Limitations\*
- c. Federally qualified health center (FQHC) services and other ambulatory services that are covered under the plan and furnished by an FQHC in accordance with section 4231 of the State Medicaid Manual (HCFA-PUB. 45-4).  
X Provided:    No Limitations X With Limitations
3. Other laboratory and x-ray services.  
X Provided:    No Limitations X With Limitations\*
- 4.a. Nursing facility services (other than services in an institution for mental diseases) for individuals 21 years of age or older.  
X Provided:    No Limitations X With Limitations\*
- b. Early and periodic screening, diagnostic and treatment services for individuals under 21 years of age, and treatment of conditions found.\*  
X Provided: X No Limitations    With Limitations\*
- c. Family planning services and supplies for individuals of child-bearing age.  
X Provided: X No Limitations    With Limitations\*

\*Description provided on attachment.

State/Territory: North Carolina

AMOUNT, DURATION AND SCOPE OF SERVICES PROVIDED MEDICALLY NEEDY  
GROUP(S): \_\_\_\_\_

4. d. 1) Face-to-Face Tobacco Cessation Counseling Services provided (by):

(i) By or under supervision of a physician;

(ii) By any other health care professional who is legally authorized to furnish such services under State law and who is authorized to provide Medicaid coverable services *other* than tobacco cessation services; or\*

(iii) Any other health care professional legally authorized to provide tobacco cessation services under State law *and* who is specifically *designated* by the Secretary in regulations. (None are designated at this time; this item is reserved for future use.)

\*describe if there are any limits on who can provide these counseling services

2) Face-to-Face Tobacco Cessation Counseling Services Benefit Package for Pregnant Women

Provided:  No limitations\*       With limitations\*\*

\*The State is providing at least four (4) counseling sessions per quit attempt.

\*\* Any benefit package that consists of *less* than four (4) counseling sessions per quit attempt should be explained below.

Please describe any limitations:

5.a. Physicians' services, whether furnished in the office, the patient's home, a hospital, a nursing facility, or elsewhere.

Provided:  No Limitations       With limitations\*

b. Medical and surgical services furnished by a dentist (in accordance with section 1905(a)(5)(B) of the Act).

Provided:  No Limitations       With limitations:

\*Description provided on attachment.

State/Territory: North Carolina

AMOUNT, DURATION, AND SCOPE OF SERVICES PROVIDED  
MEDICALLY NEEDY GROUP(S): all

---

6. Medical care and any other type of remedial care recognized under State law, furnished by licensed practitioners within the scope of their practice as defined by State law.
- a. Podiatrists' Services  
 Provided:  No Limitations  With Limitations\*
  - b. Optometrists' Services  
 Provided:  No Limitations  With Limitations\*
  - c. Chiropractors' Services  
 Provided:  No Limitations  With Limitations\*
  - d. Other Practitioners' Services  
 Provided:  No Limitations  With Limitations\*
- Nurse Practitioner criteria described in Appendix 5 of Att. 3.1-A.
7. Home Health Services
- a. Intermittent or part-time nursing service provided by a home health agency or by a registered nurse when no home health agency exists in the area.  
 Provided:  No Limitations  With Limitations\*
  - b. Home health aide services provided by a home health agency.  
 Provided:  No Limitations  With Limitations\*
  - c. Medical supplies, equipment, and appliances suitable for use in the home.  
 Provided:  No Limitations  With Limitations\*
  - d. Physical therapy, occupational therapy, or speech pathology and audiology services provided by a home health agency or medical rehabilitation facility.  
 Provided:  No Limitations  With Limitations\*

\*Description provided on attachment.

State/Territory: North Carolina

AMOUNT, DURATION AND SCOPE OF SERVICES PROVIDED  
MEDICALLY NEEDY GROUP(S): all

- 
8. Private duty nursing services.  
 Provided:     No Limitations         With limitations\*
9. Clinic services.  
 Provided:     No Limitations         With limitations\*
10. Dental services.  
 Provided:     No Limitations         With limitations\*
11. Physical therapy and related services.
- a. Physical therapy.  
 Provided:     No Limitations         With limitations\*
- b. Occupational therapy.  
 Provided:     No Limitations         With limitations\*
- c. Services for individuals with speech, hearing, and language disorders provided by or under supervision of a speech pathologist or audiologist.  
 Provided:     No Limitations         With limitations\*
12. Prescribed drugs, dentures, prosthetic devices and eyeglasses prescribed by a physician skilled in disease of the eye or by an optometrist.
- a. Prescribed drugs.  
 Provided:     No Limitations         With limitations\*
- b. Dentures  
 Provided:     No Limitations         With limitations\*

\*Description provided on attachment.

State/Territory: North Carolina

AMOUNT, DURATION AND SCOPE OF SERVICES PROVIDED  
MEDICALLY NEEDY GROUP(S): All

- 
- c. Orthotic and Prosthetic devices.  
 Provided:     No Limitations         With limitations\*
- d. Eyeglasses.  
 Provided:     No Limitations         With limitations\*
13. Other diagnostic, screening, preventive, and rehabilitative services, i.e., other than those provided elsewhere in this plan.
- a. Diagnostic services.  
 Provided:     No Limitations         With limitations\*
- b. Screening services.  
 Provided:     No Limitations         With limitations\*
- c. Preventive services.  
 Provided:     No Limitations         With limitations\*
- d. Rehabilitative services.  
 Provided:     No Limitations         With limitations\*
14. Services for individuals age 65 or older in institutions for mental diseases.
- a. Inpatient hospital services.  
 Provided:     No Limitations         With limitations\*
- b. Skilled nursing facility services.  
 Provided:     No Limitations         With limitations\*

\*Description provided on attachment.

State/Territory: North Carolina

AMOUNT, DURATION AND SCOPE OF SERVICES PROVIDED  
MEDICALLY NEEDY GROUP(S): All

---

- c. Intermediate care facility services.  
 Provided:  No Limitations  With limitations\*\*
- 15.a. Intermediate care facility services (other than such services in an institution for mental diseases) for persons determined in accordance with section 1902(a)(31)(a) of the Act, to be in need of such care.  
 Provided:  No Limitations  With limitations\*
- b. Including such services in a public institution (or distinct art thereof) for the mentally retarded or persons with related conditions.  
 Provided:  No Limitations  With limitations\*
16. Inpatient psychiatric facility service for individuals under 21 years of age.  
 Provided:  No Limitations  With limitations\*
17. Nurse-midwife services.  
 Provided:  No Limitations  With limitations\*
18. Hospice care (in accordance with section 1905(o) of the Act).  
 Provided:  No limitations  Provided in accordance with section 2302 of the Affordable Care Act  
 With limitations\*

\*Description provided on attachment.

---

TN. No. 13-007  
Supersedes  
TN. No. 00-23

Approval Date 12-16-13

Eff. Date 07/01/2013

HCFA ID: 0140P/0102A

State/Territory: NORTH CAROLINA

AMOUNT, DURATION, AND SCOPE OF SERVICES PROVIDED  
MEDICALLY NEEDY GROUP(S): \_\_\_\_\_

---

19. Case management services and Tuberculosis related services

- a. Case management services as defined in, and to the group specified in, Supplement 1 to ATTACHMENT 3.1-A (in accordance with section 1905(a)(19) or section 1915(g) of the Act).

Provided:  With limitations\*

Not provided.

- b. Special tuberculosis (TB) related services under section 1902(z) (2)(F) of the Act.

Provided:  With limitations\*

Not provided.

20. Extended services for pregnant women.

- a. Pregnancy-related and postpartum services for a 60-day period after the pregnancy ends and for any remaining days in the month in which the 60th day falls.

Provided:  Additional coverage <sup>+</sup> <sup>++</sup>

- b. Services for any other medical conditions that may complicate pregnancy.

Provided:  Additional coverage <sup>+</sup> <sup>++</sup>  Not provided.

21. Certified pediatric or family nurse practitioners' services.

Provided:  No limitations  With limitations\*

Not provided.

+ Attached is a list of major categories of services (e.g., inpatient hospital, physician, etc.) and limitations on them, if any, that are available as pregnancy-related services or services for any other medical condition that may complicate pregnancy.

++ Attached is a description of increases in covered services beyond limitations for all groups described in this attachment and/or any additional services provided to pregnant women only.

\*Description provided on attachment.



---

---

**20. DESCRIPTION OF EXTENDED SERVICES TO PREGNANT WOMEN**

Pregnancy related and postpartum services include:

Physician  
Clinic, including rural health and migrant health  
In-patient hospital  
Outpatient hospital  
Prescription drugs

The above services are provided to all Medicaid eligibles. The restrictions specified in ATTACHMENT 3.1-A.1 apply to all eligibles including pregnant women. Services available to pregnant women do not exceed the scope of services available to other eligible individuals or groups.

Pregnancy Medical Home:

Pregnancy Medical Home (PMH) services are managed care services to provide obstetric care to pregnant Medicaid recipients with the goal of improving the quality of maternal care, improving birth outcomes, and providing continuity of care. Requirements for PMH services are specified in Attachment 3.1-F.

Qualified providers must:

- be currently enrolled with the N.C. Medicaid Program;
- meet Medicaid's qualifications for participation;
- bill only for procedures, products, and services that are within the scope of their clinical practice, as defined by the appropriate licensing entity; and
- meet the Division of Medical Assistance qualifications for enrollment as a PMH provider.

PMH providers include:

1. Individual physicians or physician groups enrolled with NC Medicaid as:
  - General/family practice
  - Obstetrics/Gynecology
  - Multi-specialty
2. Federally Qualified Health Clinics (FQHC)
3. Rural Health Clinics (RHC)
4. Nurse Practitioners
5. Nurse Midwives

=====

**20. DESCRIPTION OF EXTENDED SERVICES TO PREGNANT WOMEN, CONT'D**

**Childbirth Education Classes**

Childbirth education classes include a series of classes designed to prepare pregnant women and their support person for the labor and delivery experience. These classes are based on a written curriculum that outlines the course objectives and specific content to be covered in each class as approved and published in Medicaid Clinical Coverage Policies at the NC Division of Medical Assistance website,

[www.dhhs.state.nc.us/dma/mp/mpindex.htm](http://www.dhhs.state.nc.us/dma/mp/mpindex.htm).

Qualified providers must:

- be enrolled with the N.C. Medicaid Program; and
- be certified as a childbirth educator by a nationally recognized organization for childbirth education or meet State-approved childbirth education program requirements; and be a licensed practitioner operating within the scope of their practice as defined under State law or
- be under the personal supervision of an individual licensed under State law to practice medicine.

TN No.: 10-035A  
Supersedes  
TN No.: NEW

Approval Date: 03-21-11

Effective Date: 3/01/2011

### **Dietary Evaluation and Counseling**

Dietary Evaluation and Counseling, when provided by a qualified nutritionist to Medicaid eligible pregnant and postpartum women identified as having high risk conditions by their prenatal care provider include but is not limited to:

- Nutrition assessment
- Development of an individualized care plan
- Diet therapy
- Counseling, education about needed nutrition habits/skills and follow-up
- Communication with the WIC Program, Baby Love Program and prenatal care provider as appropriate.

The high risk indicators used to assess pregnant and postpartum women's medical need for the services are as follows:

1. conditions that impact the length of gestation or the birth weight, where nutrition is an underlying cause, such as:
  - a. severe anemia (HGB<10M/DL or HCT<30)
  - b. pre-conceptionally underweight (<90% standard weight for height)
  - c. inadequate weight gain during pregnancy
  - d. intrauterine growth retardation
  - e. very young maternal age (under the age of 16)
  - f. multiple gestation
  - g. substance abuse
2. metabolic disorders such as diabetes, thyroid dysfunction, maternal PKU, or other inborn errors of metabolism
3. chronic medical conditions such as cancer, heart disease, hypertension, hyperlipidemia, inflammatory bowel disease, malabsorption syndromes, or renal disease
4. auto-immune diseases of nutritional significance such as systemic lupus erythematosus
5. eating disorders such as severe pica, anorexia nervosa, or bulimia nervosa
6. obesity when the following criteria are met:
  - BMI >30 in same woman pre-pregnancy and post partum
  - BMI >35 at 6 weeks of pregnancy
  - BMI >30 at 12 weeks of pregnancy
7. a documented history of a relative of the first degree with cardiovascular disease and/or possessing factors that significantly increase the risk of cardiovascular disease such as a sedentary lifestyle, elevated cholesterol, smoking, high blood pressure, greater than ideal body weight

Provider Qualifications

Medicaid enrolled providers who employ licensed dietitians/nutritionists or registered dietitians are eligible to provide dietary evaluation and counseling. It is the responsibility of the provider agency to verify in writing that staff meet the following qualifications:

1. a dietitian/nutritionist, currently licensed by the N.C. Board of Dietetics/Nutrition (provisional license is not acceptable)
2. a registered dietitian, currently registered with the Commission of Dietetic Registration (registration eligibility is not acceptable).

Coordination with WIC

This nutrition service is not intended to replace WIC nutrition education contacts. All individuals receiving this service must be referred to WIC to receive the two WIC nutrition education contacts.

Other Services

Other services described in this attachment and restrictions described in Attachment 3.1-A.1 apply to all pregnant women except those that are entitled as optionally categorically needy pregnant women. For this latter category of pregnant women only pregnancy-related services and family planning services are available.

State/Territory: North Carolina

AMOUNT, DURATION, AND SCOPE OF SERVICES PROVIDED  
MEDICALLY NEEDY GROUP(S): All

---

22. Respiratory care services (in accordance with section 1902(e)(9)(A) through (C) of the Act).
- Provided:  No limitations  With limitations\*
- Not provided.
23. Any other medical care and any other type of remedial care recognized under State law, specified by the Secretary.
- a. Transportation.
- Provided:  No limitations  With limitations\*
- b. Services of Christian Science nurses
- Provided:  No limitations  With limitations\*
- c. Care and services provided in Christian Science sanatoria.
- Provided:  No limitations  With limitations\*
- d. Skilled nursing facility services provided for patients under 21 years of age.
- Provided:  No limitations  With limitations\*
- e. Emergency hospital services.
- Provided:  No limitations  With limitations\*
- f. Personal care services in recipient's home, prescribed in accordance with a plan of treatment and furnished by a qualified person under supervision of a registered nurse.
- Provided:  No limitations  With limitations\*

State/Territory: North Carolina

AMOUNT, DURATION, AND SCOPE OF SERVICES PROVIDED  
MEDICALLY NEEDY GROUP(S): ALL

24. Home and Community Care for Functionally Disabled Elderly Individuals, as defined, described and limited in Supplement 2 to Attachment 3.1-A, and Appendices A-G to Supplement 2 to Attachment 3.1-A.

Provided  Not Provided

25. Personal care services furnished to an individual who is not an inpatient or resident of a hospital, nursing facility, intermediate care facility for the mentally retarded, or institution for mental disease that are (A) authorized for the individual by a physician in accordance with a plan of treatment, (B) provided by an individual who is qualified to provide such services and who is not a member of the individual's family, and (C) furnished in a home.

Provided:  State Approved (Not Physician) Service Plan Allowed

Services Outside the Home Also Allowed

Limitations Described on Attachment

Not Provided

26. Program of All-Inclusive Care for the Elderly (PACE) services, as described in Supplement 3 to Attachment 3.1-A.

Election of PACE: By virtue of this submittal, the State elects PACE as an optional State Plan service.

No election of PACE: By virtue of this submittal, the State elects to not add PACE as an optional State Plan service.

LIMITATIONS ON AMOUNT  
DURATION AND SCOPE OF SERVICES  
MEDICALLY NEEDY

Services covered for medically needy individuals are equal in amount, duration and scope to services covered for the categorically needy. Limitations are described in Attachment 3.1-A.1.

State Plan Under Title XIX of the Social Security Act  
Medical Assistance Program  
State: NORTH CAROLINA

Medicaid Program: Requirements Relating to Covered Outpatient Drugs for the Medically Needy  
**12.a. PRESCRIBED DRUGS**

---

---

Citation (s)	Provision (s)
USC 1935(d)(1)	Effective January 1, 2006, the Medicaid agency will not cover any Part D drug for full-benefit dual eligible individuals who are entitled to receive Medicare benefits under Part A or Part B.



State Plan Under Title XIX of the Social Security Act  
Medical Assistance Program  
State: NORTH CAROLINA

Medicaid Program: Requirements Relating to Covered Outpatient Drugs for the Medically Needy

**12.a. PRESCRIBED DRUGS** *continued*

Citation (s)	Provision (s)
USC 1927(d)(2) and 1935(d)(2)	<p>The Medicaid agency provides coverage for the following excluded or otherwise restricted drugs or classes of drugs, or their medical uses to all Medicaid recipients, including full benefit dual eligible beneficiaries under the Medicare Prescription Drug Benefit – Part D.</p> <p>(1) The following excluded drugs are covered:</p> <p><input checked="" type="checkbox"/> (a) Non-prescription drugs</p> <p>North Carolina (NC) will only cover selected rebateable over the counter (OTC) products when not covered by the prescription drug plans (PDPs). Examples of OTC drugs covered are: Non-sedating antihistamines e.g. Loratadine OTC and Claritin OTC, proton pump inhibitors e.g. Prilosec OTC</p>

TN No.: 14-011  
Supersedes  
TN No.: 13-005

Approval Date: 05-29-14

Effective Date: 01/01/2014

State Plan Under Title XIX of the Social Security Act  
Medical Assistance Program  
State: NORTH CAROLINA

Medicaid Program: Requirements Relating to Covered Outpatient Drugs for the Medically Needy

**12.a. PRESCRIBED DRUGS** *continued*

Citation (s)	Provision (s)
	(2) The following excluded drugs are not covered: <ul style="list-style-type: none"><li>(a) Agents when used for anorexia, weight loss, weight gain</li><li>(b) Agents when used to promote fertility</li><li>(c) Agents when used for cosmetic purposes or hair growth</li><li>(d) Covered outpatient drugs which the manufacturer seeks to require as a condition of sale that associated tests or monitoring services be purchased exclusively from the manufacturer or its designee</li><li>(e) Agents when used for the symptomatic relief of cough and colds. All legend products that contain expectorants or cough suppressants. Examples are: expectorant/antitussive combination, antihistamine/decongestant/antitussive combination, antihistamine/decongestant/ expectorant combination, antihistamine/decongestant/ expectorant/antitussive combination, antihistamine/expectorant combination, antihistamine/antitussive, antitussive/decongestant/ analgesic/expectorant, and antitussive/decongestant/ analgesic.</li><li>(f) All legend vitamins and mineral products, except prenatal vitamins and fluoride.</li></ul>

TN No.: 12-021  
Supersedes  
TN No.: 09-026

Approval Date: 02-07-13

Effective Date: 01-01-2013

STATE PLAN UNDER TITLE XIX OF THE SOCIAL SECURITY ACT  
MEDICAL ASSISTANCE PROGRAM

Attachment 3.1-C

State North Carolina

STANDARDS AND METHODS TO ASSURE HIGH QUALITY CARE

---

---

Institutional care will be provided by facilities qualified to participate in Title XVIII and/or Title XIX.

Physicians' services are those services provided within the scope of practice, as defined by State law, by or under the personal supervision of an individual licensed under State law to practice medicine, osteopathy, podiatry, and optometry. Those services, as required by State statute, performed by a licensed optometrist or podiatrist which fall within the scope of services performed by a doctor of medicine are the only podiatric and optometric services which may be covered.

Drugs will be provided only on the written prescription of a licensed practitioner qualified to prescribe and will be dispensed through registered or licensed pharmacies except for remote areas where pharmaceutical services are not available, except when dispensed by the physician.

Independent laboratories and x-ray facilities, including such facilities in a physician's office, furnishing outpatient diagnostic services must meet the standards prescribed for participation under Title XVIII.

Home health agencies must meet the standards prescribed for participation in Title XVIII.

Consultants in pharmacy, dentistry, nursing, and medicine, with advice and counsel of committees representing professional provider groups and advisory council, will participate in program planning, establishing standards, and program evaluations.

Provisions will be made for obtaining recommended medical care and services regardless of geographic boundaries.

Long term care of patients in medical institutions will be provided in accordance with procedures and practices that are based on the patient's medical and social needs and requirements.

Standards in other specialized high quality programs such as Crippled Children's Services will be incorporated as appropriate.

Rec'd 12/26/73

OPC-11# 73-45

Dated 12/21/73

R.O. Action 7/19/74

Eff. Date 10/1/73

Obsoleted by \_\_\_\_\_

Dated \_\_\_\_\_

State Plan Under Title XIX of the Social Security Act  
Medical Assistance Program  
State: NORTH CAROLINA

AMOUNT DURATION AND SCOPE OF MEDICAL AND REMEDIAL CARE AND SERVICES PROVIDED

Limitations in the Amount, Duration and Scope of Certain Items of Provided Medical and Remedial Care and Services are Described Below:

<u>CITATION</u>	Medical and Remedial	Methodologies for medically necessary ambulance
42 CFR	Care and Services	transportation are found in Attachment 3.1-A.1, page 18.
431.53	Item 24.a	Transportation services for categorically needy are
	Transportation	defined in Attachment 3.1-A and transportation services
		for medically needy are defined in Attachment 3.1-B.

An amount to reimburse nursing facilities, ICF-MR and Adult Care Homes for non-ambulance non-emergency transportation is included in Medicaid payments to those facilities.

Methods of Assuring Transportation

The North Carolina Division of Medical Assistance, or its designated agent, shall assure that necessary NEMT services are provided for beneficiaries who have a need for assistance with transportation. The designated agent is the county departments of social services. The distance to be traveled, transportation methods available, treatment facilities available, and the physical condition and welfare of the beneficiary shall determine the type of NEMT authorized. The type of transportation available may vary by region because of rural and urban conditions.

State Plan Under Title XIX of the Social Security Act  
Medical Assistance Program  
State: NORTH CAROLINA

AMOUNT DURATION AND SCOPE OF MEDICAL AND REMEDIAL CARE AND SERVICES PROVIDED

Any appropriate means of transportation which can be secured without charge through volunteer organizations, public services, recipient relatives or friends will be used. If transportation is not available without charge, payment will be made for the least expensive appropriate means of transportation available, including personal vehicle, multi-passenger van, wheelchair van, bus, taxi, train, ambulance, and other forms of public and private conveyance. Beneficiaries, family members and volunteers using their own vehicles to provide transportation are provided gas vouchers or mileage reimbursement. Mileage costs incurred shall not exceed the current IRS business rate. Mileage costs incurred by recipients and financially responsible persons shall not exceed half the current IRS business rate. Payments to beneficiaries, financially responsible individuals and volunteers are provided as an administrative service and reimbursement for these services is claimed at the administrative rate.

Transportation to in-state or out-of-state locations, that are not within the beneficiary's normal service area, shall be covered when it has been determined, on the basis of medical advice, that the needed medical services, or necessary supplementary resources, are not able to be provided by a provider/facility within the state or within the beneficiary's normal service area.

Services ancillary to NEMT shall include meals and lodging. Reimbursement for related travel expenses may not exceed the state mileage, subsistence and lodging reimbursement rates.

State Plan Under Title XIX of the Social Security Act  
Medical Assistance Program  
State: NORTH CAROLINA

AMOUNT DURATION AND SCOPE OF MEDICAL AND REMEDIAL CARE AND SERVICES PROVIDED

Attendants, including family members, are entitled to reimbursement of expenses incurred during transportation at the least expensive rate that is appropriate to the beneficiary's circumstances. Attendants, other than family members, may charge for their time when an attendant is medically necessary. Maximum reimbursement for an attendant's time shall not exceed the state hourly wage rate, nor shall an attendant be reimbursed for time spent in travel without the beneficiary. A medical professional who serves as an attendant and administers medical services during the trip may bill Medicaid for that service, but cannot also charge for his time.

Applicants/ beneficiaries are made aware of NEMT services by the following methods:

- Information on applications/re-enrollment forms
- Rights and Responsibilities Handout/Mailing
- Department of Social Services contact
- Beneficiary Handbook
- DMA Website

Compliance with NEMT policy is assured through county and state monitoring and state auditing.

Counties are required to track each trip request from intake through disposition. Effective April 1, 2012, counties are required by policy to audit 2% of the trips made each month using a state compliance monitoring tool. Reports are maintained at the county and must be provided to the state upon request and at a time of state audits.

In March 2012, a contract was executed by the state with a vendor to perform audits of the county NEMT programs based on policy. The state meets at minimum biweekly with the vendor to review

State Plan Under Title XIX of the Social Security Act  
Medical Assistance Program  
State: NORTH CAROLINA

AMOUNT DURATION AND SCOPE OF MEDICAL AND REMEDIAL CARE AND SERVICES PROVIDED

findings and take action. Counties are required to submit a corrective action plan for issues identified through the audits and to payback funds as necessary. Implementation of corrective action plan is monitored and can result in withholding of funding or termination of provider status. The audit does not affect the recipients' coverage.

---

TN No. 12-011  
Supersedes  
TN No. NEW

Approval Date: 12-07-12

Eff. Date 10/01/2012

State/Territory: North Carolina

I. Coverage of Transplant Services

Subject to the specifications, conditions, and limitations established by the State Medicaid Agency, transplant services are covered as follows:

- Coverage is limited to transplant services that are specified in the North Carolina Division of Medical Assistance Medicaid Clinical Coverage Policies. Additionally, the criteria for determining a recipient's clinical eligibility for transplantation are specified in the Medicaid Clinical Coverage Policies as well. The North Carolina Division of Medical Assistance Medicaid Clinical Coverage Policies can be located on the web at [www.dhhs.state.nc.us/dma/mp/mpindex.htm](http://www.dhhs.state.nc.us/dma/mp/mpindex.htm).
- Organs procured from outside the transplanting facility must be obtained from an organ procurement organization meeting the standards described in Section 1138 of the Social Security Act. The North Carolina Division of Medical Assistance Medicaid Clinical Coverage Policies further specifies organ procurement requirements. These policies are available on the Division's website located at [www.dhhs.state.nc.us/dma/mp/mpindex.htm](http://www.dhhs.state.nc.us/dma/mp/mpindex.htm).
- The transplant facility must meet the requirements contained in Section 1138 of the Social Security Act.
- Donor expenses are covered for certain transplants as specified in the North Carolina Division of Medical Assistance Medicaid Clinical Coverage Policies that are available on the Division's website located at [www.dhhs.state.nc.us/dma/mp/mpindex.htm](http://www.dhhs.state.nc.us/dma/mp/mpindex.htm).



State/Territory: North Carolina

II. Solid Organ Transplants

A. Medically necessary solid organ transplants and other related procedures are covered for adults and children, with prior approval. These include the following:

- Heart transplant
- Heart/lung transplant
- Lung transplant
- Liver transplant
- Kidney transplant
- Pancreas transplant
- Islet cell transplant
- Small bowel, small bowel/liver and multi-visceral transplant
- Ventricular assist device (VAD)
- Extracorporeal membrane oxygenation (ECMO), Extracorporeal life support (ECLS)
- Implantable cardioverter defibrillator (ICD)
- Biventricular Pacemaker for congestive heart failure (CHF)

Revision: HCFA-PM-87-4 (BERC)  
March 1987

Attachment 3.1-E  
Page 3  
OMB No. 0938-0193

State/Territory: North Carolina

B. Definitions

1. Cadaveric/deceased donor is a person who has been declared dead and his/her family has offered one or more organs to be used for transplantation or is a dying person that has self-declared that he/she will offer one or more organs to be used for transplantation.
2. Living donor is a living person who donates an organ or part of an organ to another person.
3. Xenotransplantation refers to the surgical transfer of cells, tissues or whole organs from one species to another.

State/Territory: North Carolina

C. Clinical Packet requirements for Prior Approval

All clinical transplant packets submitted for review should include the documentation delineated below. Incomplete clinical transplant packets will not be approved. Documentation should include:

1. Letter from recipient's physician requesting solid organ transplant and summarizing the recipient's clinical history.
2. All lab results including: Human Immunodeficiency Virus (HIV), Rapid Plasma Reagin (RPR), Hepatitis panel, Prothombin Time (PT), International Normalized Ratio (INR), infectious disease serology, inclusive of Cytomegalovirus (CMV) and Epstein-Barr Virus (EBV).
3. All diagnostic and procedure results.
4. Complete psychosocial evaluation with documentation of post-transplant care needs.
5. Psychiatric evaluation, if psychiatric history is documented.
6. Where the recipient has a history of substance abuse, completion of a substance abuse treatment program and sequential screenings for relevant substances. Specific requirements may be found in the Medicaid Clinical Coverage Policies for transplants located on the Division of Medical Assistance's website at [www.dhhs.state.nc.us/dma/mp/mpindex.htm](http://www.dhhs.state.nc.us/dma/mp/mpindex.htm).
7. Any additional clinical documentation that is requested by the North Carolina Division of Medical Assistance and/or that is required by specific Medicaid Clinical Coverage Policies.

Revision: HCFA-PM-87-4 (BERC)  
March 1987

Attachment 3.1-E  
Page 5  
OMB No. 0938-0193

State/Territory: North Carolina

D. Other

- The NC Division of Medical Assistance will consider coverage for other transplants based on clinical trials reported in peer reviewed journals, new technology assessments and medical necessity.
- Additional information regarding solid organ transplantation medical coverage criteria and donor fees has been specified in the North Carolina Division of Medical Assistance Medicaid Clinical Coverage Policies. These policies are available on the Division's website located at [www.dhhs.state.nc.us/dma/mp/mpindex.htm](http://www.dhhs.state.nc.us/dma/mp/mpindex.htm).

State/Territory: North Carolina

III. Stem Cell/Bone Marrow/Umbilical Cord Transplants

- A. Medically necessary Stem Cell/Bone Marrow/Umbilical Cord transplants and other related procedures are covered for adults and children, with prior approval. Current stem cell transplants and related procedures include:
- High Dose Chemotherapy (HDC) +/- Total Body Irradiation (TBI) including autologous/allogeneic stem cell for acute lymphocytic leukemia
  - HDC +/- TBI including autologous/allogeneic stem cell for acute myelogenous leukemia
  - HDC +/- TBI including autologous/allogeneic stem cell for chronic myelogenous leukemia
  - HDC +/- TBI including autologous/allogeneic stem cell for germ cell tumors
  - HDC +/- TBI including autologous/allogeneic stem cell for Hodgkins disease
  - HDC +/- TBI including autologous/allogeneic stem cell for Multiple Myeloma and Primary Amyloidosis
  - HDC +/- TBI including /allogeneic stem cell for Myelodysplastic diseases
  - HDC +/- TBI including /allogeneic stem cell for genetic diseases and acquired anemias
  - HDC +/- TBI including autologous stem cell for Primitive Neuroectodermal Tumors (PNET) and Ependymoma
  - HDC +/- TBI including autologous/allogeneic stem cell for Non-Hodgkins Lymphoma
  - HDC +/- TBI including autologous for ovarian cancer and germ cell tumors arising in the ovaries
  - HDC +/- TBI including autologous/allogeneic stem cell for solid tumors of childhood
  - Placental and Umbilical Cord Blood as a source of stem cells
  - Non-Myeloablative Allogeneic stem cell (Mini-Transplant, Mini-Allograft Reduced Intensity Conditioning) for the treatment of malignancies
  - Donor Leukocyte, Donor Lymphocyte or Buffy Coat Infusion for hematologic malignancies that relapse or are at high risk for relapse after allogeneic stem cell transplant
  - Photophresis for Solid Organ Rejection, Autoimmune Disease and Graft-Versus Host Disease (GVHD)
  - Bone Morphogenic Protein-2 Allograft

State/Territory: North Carolina

B. Definitions

1. Autologous means the new marrow comes from the patient/recipient. The marrow or stem cells are collected, stored and reinfused to the patient/recipient.
2. Allogeneic refers to new cells which arise from an appropriately matched donor.
3. Bone marrow transplant means a technique in which bone marrow is transplanted from one individual to another or removed from and transplanted to the same individual in order to stimulate production of blood cells. It is used to treat malignancies, certain forms of anemia and immunologic deficiencies.
4. Stem cell transplant restores stem cells, also called peripheral stem cell. The donor can be related or unrelated. The stem cells used in peripheral blood stem cell transplantation (PBSCT) come from the bloodstream. A process called apheresis or leukapheresis is used to obtain peripheral blood stem cells (PBSCs) for transplantation.
5. Mini-transplant is a type of allogeneic transplant and uses lower, less toxic doses of chemotherapy and/or radiation. It may also be called a non-myeloablative or reduced-intensity transplant.
6. Tandem transplant is a type of autologous transplant. The patient/recipient receives two sequential courses of high-dose chemotherapy with stem cell transplant.
7. Umbilical cord blood transplant is the injection of umbilical cord blood to restore an individual's own blood production system suppressed by anticancer drugs, radiation therapy.

State/Territory: North Carolina

C. Clinical Packet requirements for Prior Approval:

All clinical transplant packets submitted for review should include the documentation delineated below. Incomplete clinical transplant packets will not be approved. Documentation should include:

1. Letter from recipient's physician requesting solid organ transplant and summarizing the recipient's clinical history.
2. All prior chemotherapy regimen and dates
3. All lab results including: HIV, RPR, Hepatitis panel, PT, INR, infectious disease serology, inclusive of CMV and EBV.
4. All diagnostic and procedure results inclusive of bone marrow aspiration.
5. Complete psychosocial evaluation with documentation of post-transplant care needs.
6. Psychiatric evaluation, if psychiatric history is documented.
7. Where the recipient has a history of substance abuse, completion of a substance abuse treatment program and sequential screenings for relevant substances. Specific requirements may be found in the Medicaid Clinical Coverage Policies for transplants located on the Division of Medical Assistance's website at [www.dhhs.state.nc.us/dma/mp/mpindex.htm](http://www.dhhs.state.nc.us/dma/mp/mpindex.htm).
8. Any additional clinical documentation that is requested by the North Carolina Division of Medical Assistance and/or that is required by specific Medicaid Clinical Coverage Policies.

Revision: HCFA-PM-87-4 (BERC)  
March 1987

Attachment 3.1-E  
Page 9  
OMB No. 0938-0193

State/Territory: North Carolina

D. Other

- The NC Division of Medical Assistance will consider coverage for other transplants based on clinical trials reported in peer reviewed journals, new technology assessments and medical necessity.
- Additional information regarding stem cell/bone marrow/umbilical cord transplantation medical coverage criteria and donor fees has been specified in the North Carolina Division of Medical Assistance Medicaid Clinical Coverage Policies. These policies are available on the Division's website located at [www.dhhs.state.nc.us/dma/mp/mpindex.htm](http://www.dhhs.state.nc.us/dma/mp/mpindex.htm).



STATE PLAN UNDER TITLE XIX OF THE SOCIAL SECURITY ACT

STATE North Carolina

COORDINATION OF TITLE XIX WITH PART A AND PART B OF TITLE XVIII

---

---

The following method is used to provide benefits under Part A and Part B of title XVIII to the groups of Medicare-eligible individuals indicated:

A. Part B buy-in agreements with the Secretary of HHS. This agreement covers:

1.  Individuals, receiving SSI under title XVI or State supplementation, who are categorically needy under the State's approved title XIX plan.

Persons receiving benefits under title II of the Act or under the Railroad Retirement System are included:

Yes  No

2.  Individuals receiving SSI under title XVI, State supplementation, or a money payment under the State's approved title IV-a plan, who are categorically needy under the State's approved title XIX plan.

Persons receiving benefits under title II of the Act or under the Railroad Retirement System are included:

Yes  No

3.  All individuals eligible under the State's approved title XIX plan.

4.  Qualified Medicare beneficiaries provided by section 301 of P.L. 100-360 as amended by section 8434 of P.L. 100-647.

B. Part A group premium payment arrangement entered into with the Social Security Administration. This arrangement covers the following groups:

Qualified Medicare beneficiaries provided by section 301 of P.L. 100-360 as amended by section 8434 of P.L. 100-647.

C. Payment of Part A and Part B deductible and coinsurance costs. Such payments are made in behalf of the following groups:

1. Qualified Medicare beneficiaries provided by section 301 of P.L. 100-360 as amended by section 8434 of P.L. 100-647.
2. Categorically and Medically Needy
- 3.

TITLE VI  
MONITORING REPORT

Name of Provider \_\_\_\_\_ Date of Visit \_\_\_\_\_  
Address \_\_\_\_\_ Monitor's Name \_\_\_\_\_  
City \_\_\_\_\_ State \_\_\_\_\_ Monitor's Title \_\_\_\_\_

Information Desired:

1. The use of signs:  
\_\_\_\_\_  
\_\_\_\_\_

2. Dual Facilities:  
\_\_\_\_\_  
\_\_\_\_\_

3. The Provider's policy with respect to the order of seeing patients:  
 Appointments Only  
 Walk-in Only  
 Appointments and Walk-in  
 Procedure for logging walk-in patients? \_\_\_\_\_  
\_\_\_\_\_

Comments: \_\_\_\_\_  
\_\_\_\_\_

4. Does the Provider have a policy regarding the use of courtesy titles?  
\_\_\_\_\_  
\_\_\_\_\_

ADDITIONAL COMMENTS: \_\_\_\_\_  
\_\_\_\_\_  
\_\_\_\_\_  
\_\_\_\_\_

Effective Date 10/1/75

TITLE VI  
MONITORING REPORT

Name of Provider \_\_\_\_\_ Date of Visit \_\_\_\_\_  
Address \_\_\_\_\_ Monitor's Name \_\_\_\_\_  
City \_\_\_\_\_ State \_\_\_\_\_ Monitor's Title \_\_\_\_\_

Information Desired:

1. The use of signs:

\_\_\_\_\_  
\_\_\_\_\_

2. Dual Facilities:

\_\_\_\_\_  
\_\_\_\_\_

3. The Provider's policy with respect to the order of seeing patients:

- \_\_\_ Appointments Only
- \_\_\_ Walk-in Only
- \_\_\_ Appointments and Walk-in
- \_\_\_ Procedure for logging walk-in patients? \_\_\_\_\_

\_\_\_\_\_

Comments: \_\_\_\_\_

\_\_\_\_\_

4. Does the Provider have a policy regarding the use of courtesy titles?

\_\_\_\_\_  
\_\_\_\_\_

ADDITIONAL COMMENTS: \_\_\_\_\_

\_\_\_\_\_

\_\_\_\_\_

\_\_\_\_\_

\_\_\_\_\_

Effective Date 10/1/75

STATE PLAN UNDER TITLE XIX OF THE SOCIAL  
SECURITY ACT MEDICAL ASSISTANCE PROGRAM

Attachment 4.11-A

State North Carolina

STANDARDS FOR INSTITUTIONS

---

---

Institutions must meet standards prescribed for participation in Titles XVIII and XIX. Those standards are specified by State licensing law and by Federal law or regulations and are kept on file in the single State agency and are available on request.

Rec'd 12-26-73

OPC-11# 73-45 Dated 12-21-73

R.O. Action 7-19-78

Eff. Date 10-1-73

Obsoleted by \_\_\_\_

Dated \_\_\_\_\_

State/Territory North Carolina

A Memorandum of Understanding Agreement exists between the Division of Medical Assistance and the Division of Vocational Rehabilitation Services of the North Carolina Department of Health and Human Services.

TN No. 00-03  
Supercedes  
TN No. 94-14

Approval Date **Aug 02 2000**

Eff. Date 04/01/00

A Memorandum of Understanding Agreement exists between the Division of Medical Assistance and the Division of Public Health within the Department of Health and Human Services.

TN No. 00-03  
Supersedes  
TN No. 92-36

Approval Date Aug 02 2000

Eff. Date 04/01/00

State/Territory North Carolina

A Memorandum of Understanding Agreement exists between the Division of Medical Assistance and the Division of Mental Health, Developmental Disabilities and Substance Abuse Services of the North Carolina Department of Health and Human Services.

TN No. 00-03  
Supercedes  
TN No. 94-14

Approval Date Aug 02 2000

Eff. Date 04/01/00

State/Territory North Carolina

A Memorandum of Understanding Agreement exists between the Division of Medical Assistance and the Division of Facility Services of the North Carolina Department of Health and Human Services.

TN No. 00-03  
Supercedes  
TN No. 94-14

Approval Date Aug 02 2000

Eff. Date 04/01/00



State/Territory North Carolina

A Memorandum of Understanding Agreement exists between the Division of Medical Assistance and the Division of Aging of the North Carolina Department of Health and Human Services.

TN No. 00-03  
Supercedes  
TN No. 94-14

Approval Date Aug 02 2000

Eff. Date 04/01/00

State/Territory North Carolina

A Memorandum of Understanding Agreement exists between the Division of Medical Assistance and the Division of Services for the Blind of the North Carolina Department of Health and Human Services.

TN No. 00-03  
Supercedes  
TN No. 94-14

Approval Date Aug 02 2000

Eff. Date 04/01/00

State/Territory North Carolina

A Memorandum of Understanding Agreement exists between the Division of Medical Assistance and the Division of Social Services of the North Carolina Department of Health and Human Services.

TN No. 00-03  
Supersedes  
TN No. 94-18

Approval Date Aug 02 2000

Eff. Date 04/01/00

STATE PLAN UNDER TITLE XIX OF THE SOCIAL SECURITY ACT

State/Territory: North Carolina

LIENS AND ADJUSTMENTS OR RECOVERIES

---

1. The State uses the following process for determining that an institutionalized individual cannot reasonably be expected to be discharged from the medical institution and return home:  
  
Review of documentary evidence (level of care documentation, plan of care, hospital discharge summary, discharge planner's records, or physician's statement) indicates no plans or date for discharge or specific dates that institutional care is needed. When an individual continues to be institutionalized beyond the plans for discharge, it is presumed to be permanent.
2. The following criteria are used for establishing that a permanently institutionalized individual's son or daughter provided care as specified under regulations at 42 CFR §433.36(f):  
  
Not Applicable. State does not impose liens.
3. The State defines the terms below as follows:  
  
Not applicable. State does not impose liens.
  - o estate
  - o individual's home
  - o equity interest in the home
  - o residing in the home for at least one or two years on a continuous basis, and
  - o lawfully residing.

STATE PLAN UNDER TITLE XIX OF THE SOCIAL SECURITY ACT

State/Territory: North Carolina

4. The State defines undue hardship as follows:

When an heir is dependent on assets in the estate of the deceased for financial support or residence.

5. The following standards and procedures are used by the State for waiving estate recoveries when recovery would cause an undue hardship, and when recovery is not cost-effective:

1. Real or personal property included in the estate is the sole source of income for a surviving heir and his or her spouse and related family members in his or her household and the gross income available to the surviving heir and his or her spouse and related family members in his or her household is below 200 percent of the federal poverty level.
2. Recovery would result in forced sale of the residence of a surviving heir who is living in and has continuously lived in the property since the decedent's death and who lived in the property for at least 12 months immediately prior to and on the date of the decedent's death and who would be unable to obtain an alternate residence because the gross income available to the surviving heir and his or her spouse and related family members in his or her household is below 200 percent of the federal poverty level and assets of the surviving heir and his or her spouse and related family members of his or her household are valued below twelve thousand dollars (\$12,000).

6. The State defines cost-effective as follows (include methodology/thresholds used to determine cost-effectiveness):

The total assets in the estate are below \$5,000 or the amount of Medicaid payments subject to recovery is less than \$3,000.

7. The State uses the following collection procedures (include specific elements contained in the advance notice requirement, the method for applying for a waiver, hearing and appeals procedures, and time frames involved):

At the time the claim is filed, the administrator of the estate is notified in writing that recovery will be waived when any of the following conditions are met:

- There is a surviving legal spouse, child(ren) under age 21, or a blind or disabled child(ren) of any age.
- Total assets in the estate are less than \$5,000 or the total Medicaid payments subject to recovery are less than \$3,000.
- Recovery will cause undue or substantial hardship to a surviving heir.

A claim of undue hardship must be made within 60 days of date of notice of the Medicaid claim. Each claim of undue hardship will be evaluated within 90 calendar days from the date of receipt. A written decision will be made within 10 calendar days after completing the review. If the heir disagrees, he may further appeal to the Office of Administrative Hearings (OAH) within 60 calendar days from receipt of the decision.

STATE PLAN UNDER TITLE XIX OF THE SOCIAL SECURITY ACT

State: North Carolina

- A. The following charges are imposed on the categorically needy for services other than those provided under Section 1905(a)(1) through (5) and (7) of the Social Security Act:

Service	Type Charge			Amount and Basis for Determination
	Deductible	Coinsurance	Co-Pay	
Podiatrists			X	\$3.00 per visit, based on the State's average payment of \$94.07 per visit
Outpatient			X	\$3.00 per outpatient visit, based on the State's average payment of \$311.13 per outpatient visit
Physicians			X	\$3.00 per visit, based on the State's average payment of \$110.61 per visit
Drugs			X	\$3.00 per prescription for Brand Name and Generic drugs, based on the State's average payment of \$66.93 per prescription
Dental			X	\$3.00 per visit, based on the State's average payment of \$202.56 per visit
Chiropractic			X	\$2.00 per visit, based on the State's average payment of \$33.73 per visit
Optical Supplies and Services			X	\$2.00 per visit, based on the State's average payment of \$25.21 per visit
Optometrists			X	\$3.00 per visit, based on the State's average payment of \$79.72 per visit
Non-Emergency Visit in Hospital ER			X	\$3.00 per visit, based on the State's average payment of \$247.30 per visit

TN No.: 05-016

Supersedes

TN No.: 01-26

Approval Date: 02/06/06

Effective Date: 11/01/05

STATE PLAN UNDER TITLE XIX OF THE SOCIAL SECURITY ACT

State: North Carolina

B. The method used to collect cost sharing charges for categorically needy individuals:

Providers are responsible for collecting the cost sharing charges from individuals.

The agency reimburses providers the full Medicaid rate for services and collects the cost sharing charges from individuals.

C. The basis for determining whether an individual is unable to pay the charge, and the means by which such an individual is identified to providers, is described below:

Federal limits on the services for which co-payment applies and State limits on the number of covered physicians' services and prescription drugs restricts the maximum co-payment charges. The State's scope of services is broad and eligible recipients have relatively low, if any, out-of-pocket medical expenses; therefore, all recipients subject to co-payment are able to pay the minimal charges. Should a recipient claim to be unable to pay the required co-payment, the provider may not deny him service, but may arrange for the recipient to pay the co-payment at a later date.

STATE PLAN UNDER TITLE XIX OF THE SOCIAL SECURITY ACT

State: North Carolina

- D. The procedures for implementing and enforcing the exclusions from cost sharing contained in 42 CFR 447.53(b) are described below:

Providers must bill total charges on the claim form. The claims processing system deducts the appropriate amount of co-payment. Services excluded from co-payment are:

ICF, SNF, ICF-MR	Non-hospital Dialysis
Home Health	State-owned mental hospitals
Rural Health	Services to children under age 21
Hearing Aid	Services related to pregnancy
Ambulance	Hospital inpatient and emergency room
EPSDT	HMO and Prepaid Plan
Family Planning	
Home Community-Based Alternative Program services	
Services covered by both Medicare and Medicaid	
Other diagnostic, screening, preventive and rehabilitative services	

- E. Cumulative maximums on charges:

State policy does not provide for cumulative maximums.

Cumulative maximums have been established as described below:



STATE PLAN UNDER TITLE XIX OF THE SOCIAL SECURITY ACT

State: North Carolina

- A. The following charges are imposed on the medically needy for services other than those provided under Section 1905(a)(1) through (5) and (7) of the Social Security Act:

Service	Type Charge			Amount and Basis for Determination
	Deductible	Coinsurance	Co-Pay	
Podiatrists			X	\$3.00 per visit, based on the State's average payment of \$94.07 per visit
Outpatient			X	\$3.00 per outpatient visit, based on the State's average payment of \$311.13 per outpatient visit
Physicians			X	\$3.00 per visit, based on the State's average payment of \$110.61 per visit
Drugs			X	\$3.00 per prescription for Brand Name and Generic drugs, based on the State's average payment of \$66.93 per prescription
Dental			X	\$3.00 per visit, based on the State's average payment of \$202.56 per visit
Chiropractic			X	\$2.00 per visit, based on the State's average payment of \$33.73 per visit
Optical Supplies and Services			X	\$2.00 per visit, based on the State's average payment of \$25.21 per visit
Optometrists			X	\$3.00 per visit, based on the State's average payment of \$79.72 per visit
Non-Emergency Visit in Hospital ER			X	\$3.00 per visit, based on the State's average payment of \$247.30 per visit

TN No.: 05-016

Supersedes

TN No.: 01-26

Approval Date: 02/06/06

Effective Date: 11/01/05

STATE PLAN UNDER TITLE XIX OF THE SOCIAL SECURITY ACT

State: North Carolina

B. The method used to collect cost sharing charges for medically needy individuals:

X Providers are responsible for collecting the cost sharing charges from individuals.

— The agency reimburses providers the full Medicaid rate for services and collects the cost sharing charges from individuals.

C. The basis for determining whether an individual is unable to pay the charge, and the means by which such an individual is identified to providers, is described below:

Federal limits on the services for which co-payment applies and State limits on the number of covered physicians' services and prescription drugs restricts the maximum co-payment charges. The State's scope of services is broad and eligible recipients have relatively low, if any, out-of-pocket medical expenses; therefore, all recipient subject to co-payment are able to pay the minimal charges. Should a recipient claim to be unable to pay the required co-payment, the provider may not deny him service, but may arrange for the recipient to pay the co-payment at a later date.

STATE PLAN UNDER TITLE XIX OF THE SOCIAL SECURITY ACT

State: North Carolina

- D. The procedures for implementing and enforcing the exclusions from cost sharing contained in 42 CFR 447.53(b) are described below:

Providers must bill total charges on the claim form. The claims processing system deducts the appropriate amount of co-payment. Services excluded from co-payment are:

ICF, SNF, ICF-MR	Non-hospital Dialysis
Home Health	State-owned mental hospitals
Rural Health	Services to children under age 21
Hearing Aid	Services related to pregnancy
Ambulance	Hospital inpatient and emergency room
EPSDT	HMO and Prepaid Plan
Family Planning	
Home Community-Based Alternative Program services	
Services covered by both Medicare and Medicaid	
Other diagnostic, screening, preventive and rehabilitative services	

- E. Cumulative maximums on charges:

State policy does not provide for cumulative maximums.

Cumulative maximums have been established as described below:

State: North Carolina

---

Citation	Condition or Requirement
----------	--------------------------

---

1932(a)(1)(A)

A. Section 1932(a)(1)(A) of the Social Security Act.

The State of North Carolina enrolls Medicaid beneficiaries on a mandatory basis into managed care entities. (managed care organization (MCOs) and/or primary care case managers (PCCMs) in the absence of section 1115 or section 1915(b) waiver authority. This authority is granted under section 1932(a)(1)(A) of the Social Security Act (the Act). Under this authority, a state can amend its Medicaid state plan to require certain categories of Medicaid beneficiaries to enroll in managed care entities and/or primary care case management entities without being out of compliance with provisions of section 1902 of the Act on state wideness (42 CFR 431.50), freedom of choice (42 CFR 431.51) or comparability (42 CFR 440.230). This authority may *not* be used to mandate enrollment in Prepaid Inpatient Health Plans (PIHPs), Prepaid Ambulatory Health Plans (PAHPs), nor can it be used to mandate the enrollment of Medicaid beneficiaries who are Medicare eligible, who are Indians (unless they would be enrolled in certain plans—see D.2.ii. below), or who meet certain categories of “special needs” beneficiaries (see D.2.iii. - vii. below)

B. General Description of the Program and Public Process.

For B.1 and B.2, place a check mark on any or all that apply.

1932(a)(1)(B)(i)  
1932(a)(1)(B)(ii)  
42 CFR 438.50(b)(1)

1. The State will contract with an

- i. MCO
- ii. PCCM (including capitated PCCMs that qualify as PAHPs)
- iii. Both

42 CFR 438.50(b)(2)  
42 CFR 438.50(b)(3)

2. The payment method to the contracting entity will be:

- i. fee for service;
- ii. capitation;
- iii. a case management fee;
- iv. a bonus/incentive payment;
- v. a supplemental payment, or
- vi. other. (Please provide a description below).

Providers serving as a Pregnancy Medical Home are paid an incentive pay for performing an initial prenatal screening using a standardized tool and for an incentive payment for a postpartum visit.

TN No.: 12-022  
Supersedes  
TN No.: 10-035A

Approval Date: 06-12-13

Effective Date: 01/01/2013

State: North Carolina

---

Citation

Condition or Requirement

---

In addition, providers are paid an enhanced fee for vaginal deliveries. Providers are exempted from the requirement to obtain prior approval for ultrasounds. Pregnancy Medical Home providers are not paid a PM/PM.

North Carolina is transitioning from a basic PCCM program, Carolina ACCESS, to an enhanced PCCM program, Community Care of North Carolina (CCNC). CCNC is a composite of regional networks operating statewide. The state currently contracts with each network to carry out the functions of the program. To operationalize this transition, the state will contract with North Carolina Community Care Networks, Inc. (NCCCN) to administratively oversee the networks, and by holding NCCCN contractually responsible, to ensure regional networks and CCNC affiliated providers meet program goals and performance measures.

NCCCN is a physician-led private non-profit organization with the expertise and resources to ensure a healthcare delivery system that is cost efficient and driven to achieve patient centered quality health care. With this transition, the state will no longer contract directly with the networks. NCCCN will enter into contracts with each of the networks to continue operation of CCNC. Each network builds private and public partnerships where community providers and resources plan cooperatively for meeting patient needs. Health care management is provided at the community level, allowing local solutions to achieve desired outcomes. Because health care is planned and provided at the community level, larger community health issues can be addressed. NCCCN will ensure standardized performance and utilization metrics are implemented and achieved state-wide.

The state will continue to require a PCCM contract with providers to serve as health homes for Medicaid, Health Choice and targeted populations. To participate as a health home in CCNC, providers must also contract with NCCCN and the network with which it affiliates.

Providers serving as Carolina Access (CA) PCPs are encouraged to join a network to establish their role as a health home for Medicaid and Health Choice beneficiaries. If a CA provider chooses not to affiliate with a network, the enrolled beneficiaries who are in a mandatory group will be required to choose a CCNC provider. Beneficiaries who are voluntary for enrollment can choose to enroll with a network affiliated provider or can choose to opt out of CCNC. The state is sensitive to the possibility that this could create a temporary access to care issue and the state has created a process that identifies beneficiaries for whom there is no PCP available within 30 miles of their residence. In these situations, the state and NCCCN will work cooperatively to develop and ensure appropriate access; however, beneficiaries will remain exempt until access is available.

TN No.: 12-022  
Supersedes  
TN No.: 10-035A

Approval Date: 06-12-13

Effective Date: 01/01/2013

State: North Carolina

---

Citation

Condition or Requirement

---

NCCCN Responsibilities:

Using a patient centered team approach, NCCCN utilizes human and organizational resources to develop and implement a population management approach with enhanced and coordinated care for enrolled beneficiaries through:

- prevention and screenings;
- standardization of evidence-based best practices;
- community-based care coordination;
- care management;
- patient monitoring;
- investments in health information technology;
- health information exchange;
- data analytics for population stratification and prioritization;
- medication reconciliation;
- transitional care support;
- self-management coaching;
- reimbursement incentives to increase the quality and efficiency of care for patient populations;
- disease management; and
- linkages to community resources.

To accomplish this, NCCCN provides:

- Standardized, clinical, and budgetary coordination;
- Oversight and reporting;
- Locating, coordinating and monitoring the health care services of enrolled populations;
- Comprehensive statewide quantitative performance goals and deliverables;
- Utilization management;
- Quality of care analytics;
- Access to care measures;
- Financial budgeting, forecasting, and reporting methodologies;
- Predictable cost containment methodologies;
- Outcome driven clinical and financial metrics; and
- Training, education, mentorship and supervision.

State: North Carolina

---

Citation	Condition or Requirement
----------	--------------------------

---

Network Responsibilities:

Each network operates under the direction of a network director, clinical director, and network steering committee. The steering committee is composed of community leaders and organizations involved in planning for or providing services to Medicaid and Health Choice beneficiaries. Networks ensure that there is a sufficient panel of primary care providers to serve enrolled populations within the regional catchment area. A local medical director and board provide clinical direction and supervision to the network on initiatives agreed upon by DMA and NCCCN. Networks hire or contract with professionals who have expertise to lead and support each initiative. These experts include but are not limited to:

- Medical Director who chairs a Medical Management Committee;
- Care managers (nurses and social workers);
- Network and Clinical Pharmacists;
- Psychiatrists;
- Pregnancy Home Nurse Coordinator;
- CC4C Coordinator;
- Health Check program Coordinator; and
- Palliative Care Coordinator.

Networks establish uniform processes for functions that include but not limited to:

- Enrollee complaints;
- Performance measures;
- Use of CMIS and data reporting to identify patients at highest risk and who could benefit from care management services;
- Development of patient centered care plans in coordination with the primary care provider;
- Transitional support;
- Training of staff to develop skills to provide care management services; and
- Population management strategies (disease and care management pathways and expectations).

State: North Carolina

---

Citation	Condition or Requirement
----------	--------------------------

---

Provider Responsibilities:

Medicaid enrolled providers can qualify to be a primary care provider in the CCNC program when the conditions of the contract with the network and NCCCN are met and maintained. These requirements include but are not limited to the following:

- The provision of coordinated and comprehensive care;
- Compliance with CCNC initiatives and promotion of service integration and self-management;
- The application of evidence based best practice in coordination with network and care managers;
- Coordination with care managers in developing and carrying out patient plans of care;
- Cooperation and collaboration with NCCCN and networks to implement initiatives;
- Serving as a patient centered health home;
- Implementing strategies of population based strategies of care;
- Using the Informatics Center for reports and analytics to improve patient care;
- Carrying out disease management activities of NCCCN; and
- Demonstrating improvement in quality and cost of care.

To affect positive changes in the delivery of prenatal care and pregnancy outcomes; North Carolina established a medical home for pregnant Medicaid beneficiaries called a Pregnancy Medical Home (PMH). Case management services for Medicaid pregnant women are part of the managed care model. The CCNC networks receive a PM/PM to work directly with PMHs and to provide population management and care/case management for this population.

A PMH provider may also be a CCNC-PCP but it is not required. A PMH must agree to a set of performance measures which are different from the measures for CCNC PCPs. The following are examples and may change over time based on best practices and data-:

- Obtain and maintain a Cesarean Section rate of 20% or below;
- No elective inductions before 39 weeks;
- Engage in the 17 P program; and
- Complete high risk screenings on beneficiaries.



State: North Carolina

---

Citation

Condition or Requirement

---

A provider who agrees to be a PMH is paid fee for service and receives an incentive and enhanced delivery rate for each Medicaid beneficiary. The provider does not receive a PM/PM for being a PMH.

PMH providers are assigned a pregnancy care manager to work with their high risk pregnant population. These high risk pregnant women receive services based upon their level of need. This program is outcome driven and measured. The following are examples of the performance measures and may change over time:

- Increase number of high risk patients that receive a comprehensive assessment;
- Increase the postpartum visit rate; and
- Increase the percent of eligible at-risk women that receive the 17P injections.

Case management services for the pregnant woman population was previously fee for service and is now being moved to the managed care model.

CCNC operates the Care Coordination for Children program (CC4C) which provides care/case management for high risk and high cost children aged birth up to age 5, excluding Early Intervention. Eligible children receive population management, care management, and coordination of treatment and prevention. This program is outcome driven and measured. The following are examples of the performance measures and may change over time:

- Increase rate of first visits by NICU graduates within 1 month of discharge;
- Increase rate of comprehensive assessments completed; and
- Increase number of children who have a medical home that have special health care needs and/or are in foster care.

Case management services for high risk children aged birth up to age 5 was previously fee for service and is now being moved to the managed care model.

North Carolina expanded the use of the regional networks to provide these activities to high risk and high cost children or pregnant women not enrolled with a network. The networks are also paid a pm/pm for these services when provided to non-enrolled beneficiaries.

State: North Carolina

---

Citation	Condition or Requirement
----------	--------------------------

---

The PM/PM for care/case management of the pregnant women and children birth up to age 5 was based on the current fee for service cost of the maternal care coordination targeted case management program and the child service coordination case management program. The total expenditures in the base year were divided by the total beneficiary population to establish the PM/PM rate. These rates were actuarially certified as being developed in accordance with generally accepted actuarial practices and are appropriate for the Medicaid covered populations and services under the managed care contract and PMPM rates

DMA shall set forth all payments to the provider including enhanced services reimbursement and enhanced management fees and that the contracts must be reviewed and approved by CMS.

1905(t)  
42 CFR 440.168  
42 CFR 438.6(c)(5)(iii)(iv)

3. For states that pay a PCCM on a fee-for-service basis, incentive payments are permitted as an enhancement to the PCCM's case management fee, if certain conditions are met.

If applicable to this state plan, place a check mark to affirm the state has met *all* of the following conditions (which are identical to the risk incentive rules for managed care contracts published in 42 CFR 438.6(c)(5)(iv)).

- i. Incentive payments to the PCCM will not exceed 5% of the total FFS payments for those services provided or authorized by the PCCM for the period covered.
- ii. Incentives will be based upon specific activities and targets.
- iii. Incentives will be based upon a fixed period of time.
- iv. Incentives will not be renewed automatically.
- v. Incentives will be made available to both public and private PCCMs.
- vi. Incentives will not be conditioned on intergovernmental transfer agreements.
- vii. Not applicable to this 1932 state plan amendment.

TN No.: 12-022  
Supersedes  
TN No.: 10-035A

Approval Date: 06-12-13

Effective Date: 01/01/2013

State: North Carolina

---

Citation	Condition or Requirement
CFR 438.50(b)(4)	<p>4. Describe the public process utilized for both the design of the program and its initial implementation. In addition, describe what methods the state will use to ensure ongoing public involvement once the state plan program has been implemented. (<i>Example: public meeting, advisory groups.</i>)</p>
	<p>The PCCM program was founded with input from the medical provider community and other agencies involved in public service delivery. Physician and physician professional organizations have always been instrumental in developing initiatives and direction for the program. As community networks were being developed, social service agencies, physicians, and hospitals became participants in planning at the community level how Medicaid beneficiaries could best be served with quality medical care and care management. Each network has a steering committee whose membership includes representatives from the department of social services, physicians, etc. Networks also have local medical management committees whose membership is composed of representatives from the medical community, i.e., physicians, hospital etc. Each network medical director participates on the statewide Medical Management Committee that advises the PCCM program on a statewide level. A provider satisfaction survey using an external vendor will be conducted every two years to maintain continued input from providers who participate in the program but who may not be part of an advisory committee.</p>
	<p>Beneficiaries enrolled with the PCCM managed care program have public input through the state's toll free customer service phone center which is staffed from eight to five, Monday through Friday. The toll free number for the state customer service center is 1-800-662-7030.</p>
	<p>The local CCNC networks also work with their enrollees on self-management strategies for many of the chronic diseases that are managed through the program. This provides an opportunity for the beneficiary to have involvement in the care management plan being proposed. In addition, the health home/PCP works closely with the high risk enrollee and their family in the development of a health care team and patient-centered care plan to support the enrollee in managing their chronic condition(s), as appropriate.</p>

Citation

Condition or Requirement

Beneficiaries are also able to submit a concern about the program through a written complaint process.

Enrollees have public input through a Patient Satisfaction Survey. The survey is used to collect data on satisfaction, access, health status, utilization, and trust. The tool used to collect the data is the CAHPS survey for children and adults. A patient satisfaction survey will be conducted by an external vendor every three (3) years.

The NC Medical Care Advisory Committee reviews all major program changes for the Medicaid program. Beneficiaries have an opportunity to serve on this Committee.

1932(a)(1)(A)

5. The state plan program will X /will not\_\_\_ implement mandatory enrollment into managed care on a statewide basis. If not statewide, mandatory\_\_\_\_/ voluntary\_\_\_\_ enrollment will be implemented in the following county/area(s):
- i. county/counties (mandatory) \_\_\_\_\_
  - ii. county/counties (voluntary)\_\_\_\_\_
  - iii. area/areas (mandatory)\_\_\_\_\_
  - iv. area/areas (voluntary)\_\_\_\_\_

C. State Assurances and Compliance with the Statute and Regulations.

If applicable to the state plan, place a check mark to affirm that compliance with the following statutes and regulations will be met.

1932(a)(1)(A)(i)(I)  
1903(m)  
42 CFR 438.50(c)(1)

1. \_\_\_The state assures that all of the applicable requirements of section 1903(m) of the Act, for MCOs and MCO contracts will be met.

1932(a)(1)(A)(i)(I)  
1905(t)  
42 CFR 438.50(c)(2)  
1902(a)(23)(A)

2. X The state assures that all the applicable requirements of section 1905(t) of the Act for PCCMs and PCCM contracts will be met.

1932(a)(1)(A)

3. X The state assures that all the applicable requirements of section 1932.

State: North Carolina

---

Citation	Condition or Requirement
	(including subpart (a)(1)(A)) of the Act, for the state's option to limit freedom of choice by requiring recipient to receive their benefits through managed care entities will be met.
1932(a)(1)(A) 42 CFR 431.51 1905(a)(4)(C)	4. <u>X</u> The state assures that all the applicable requirements of 42 CFR 431.51 regarding freedom of choice for family planning services and supplies as defined in section 1905(a)(4)(C) will be met.
1932(a)(1)(A) 42 CFR 438 42 CFR 438.50(c)(4) 1903(m)	5. <u>X</u> The state assures that all applicable managed care requirements of 42 CFR Part 438 for MCOs and PCCMs will be met.
1932(a)(1)(A) 42 CFR 438.6(c) 42 CFR 438.50(c)(6)	6. ____ The state assures that all applicable requirements of 42 CFR 438.6(c) for payments under any risk contracts will be met.
1932(a)(1)(A) CFR 447.362 42 CFR 438.50(c)(6)	7. ____ The state assures that all applicable requirements of 42 CFR 447.362 for 42 payments under any nonrisk contracts will be met.
45 CFR 74.40	8. ____ The state assures that all applicable requirements of 45 CFR 92.36 for procurement of contracts will be met.

D. Eligible groups

- 1932(a)(1)(A)(i)
1. List all eligible groups that will be enrolled on a mandatory basis.
    - Work First for Family Assistance (formerly AFDC)
    - Family and Children's Medicaid without Medicaid deductibles (formerly AFDC-related)
    - Medicaid for the Aged, Blind and Disabled (MAA, MAB, MAD, MSB)
    - Residents of Adult Care Homes (SAD, SAA)
    - Special Assistance In-Home (SAIH)
    - Qualified Alien
    - Health Choice (North Carolina's S-CHIP program)

Children under age 19 identified as Children with Special Health Care Needs, dual eligibles, and Indians who are members of a Federally recognized tribes are mandatory exempt.
  2. Mandatory exempt groups identified in 1932(a)(1)(A)(i) and 42 CFR 438.50.

State: North Carolina

---

Citation	Condition or Requirement
1932(a)(2)(B) 42 CFR 438(d)(1)	<p data-bbox="589 422 1458 478">Use a check mark to affirm if there is voluntary enrollment any of the following mandatory exempt groups.</p> <p data-bbox="589 510 1203 543">i. <u>X</u> Recipients who are also eligible for Medicare.</p> <p data-bbox="646 573 1458 667"><i>If enrollment is voluntary, describe the circumstances of enrollment. (Example: Recipients who become Medicare eligible during mid-enrollment, remain eligible for managed care and are not disenrolled into fee-for-service.)</i></p> <p data-bbox="589 699 1458 940">North Carolina moved to an opt-out process for enrolling dual eligible beneficiaries. Dual beneficiaries receive a letter informing them of the name, address, and phone number of the health home to which they have been assigned unless they contact the local department of social services. Assignment is based on an historical relationship with a provider and if no relationship can be determined, the beneficiary is assigned to a health home within a 30 mile radius of the beneficiary's home. The letter also informs them of their right to disenroll, change their medical home, and enroll on a month to month basis.</p>
1932(a)(2)(C) 42 CFR 438(d)(2)	<p data-bbox="589 982 1458 1039">The State assures that beneficiaries will be permitted to change medical homes or disenroll from a managed care plan on a month to month basis.</p> <p data-bbox="589 1073 1458 1283">ii. <u>X</u> Indians who are members of Federally recognized Tribes except when the MCO or PCCM is operated by the Indian Health Service or an Indian Health program operating under a contract, grant or cooperative agreement with the Indian Health Service pursuant to the Indian Self Determination Act; or an Urban Indian program operating under a contract or grant with the Indian Health Service pursuant to title V of the Indian Health Care Improvement Act.</p> <p data-bbox="646 1314 1458 1434">Native Americans are not part of the opt-out process. When making application for medical assistance, they are informed that they may enroll, disenroll, or change their medical home on a month to month basis if they opt to enroll.</p>
1932(a)(2)(A)(i) 42 CFR 438.50(d)(3)(i)	<p data-bbox="589 1472 1458 1528">The State assures that beneficiaries will be permitted to change medical homes or disenroll from a managed care plan on a month to month basis.</p> <p data-bbox="589 1560 1458 1617">iii. <u>X</u> Children under the age of 19 years, who are eligible for Supplemental Security Income (SSI) under title XVI.</p>

State: North Carolina

---

Citation	Condition or Requirement
1932(a)(2)(A)(iii) 42 CFR 438.50(d)(3)(ii)	iv. ___ Children under the age of 19 years who are eligible under 1902(e)(3) of the Act.
1932(a)(2)(A)(v)	v. <u>X</u> Children under the age of 19 years who are in foster care or other out-of-the-home placement.
42 CFR 438.50(3)(iii) 1932(a)(2)(A)(iv) 42 CFR 438.50(3)(iv)	vi. <u>X</u> Children under the age of 19 years who are receiving foster care or adoption assistance under title IV-E.
1932(a)(2)(A)(ii) 42 CFR 438.50(3)(v)	vii. <u>X</u> Children under the age of 19 years who are receiving services through a family-centered, community based, coordinated care system that receives grant funds under section 501(a)(1)(D) of title V, and is defined by the state in terms of either program participation or special health care needs.

With the exception of children receiving foster care services or adoption assistance, North Carolina has moved to an-opt out process for enrolling children with special health care needs. Parents/guardians of these children receive a letter informing them of the name, address, and phone number of the health home to which assignment has been made unless they contact the local department of social services. Auto-assignment is made to a health home with which there is an historical relationship if that can be determined. If there is no relationship with a health home, the beneficiary is assigned to a health home within 30 miles of the beneficiary's residence. The letter also informs them of their right to disenroll, change their health home, and enroll at any time.

As a result of law P.L. 110-351/H.R.6893, Fostering Connections to Success and Increasing Adoption Act of 2008, the division works closely with the North Carolina Pediatric Society, practicing pediatricians and the North Carolina Division of Social Services to enroll foster children into health homes created by the PCCM program to plan for continued medical care of children with special health care needs.

The State assures that these beneficiaries will be permitted to change health homes or disenroll from the PCCM program on a month to month basis.

E. Identification of Mandatory Exempt Groups

- |                                |   |
|--------------------------------|---|
| 1932(a)(2)<br>42 CFR 438.50(d) | 1. Describe how the state defines children who receive services that are funded under section 501(a)(1)(D) of title V. ( <i>Examples: children receiving services at a specific clinic or enrolled in a particular program.</i> ) |
|--------------------------------|---|

State: North Carolina

---

Citation	Condition or Requirement
	The State defines these children in terms of special health care needs and program participation in a Children's Developmental Service Agency (CDSA) or Child Special Health Services (CSHS).
1932(a)(2) 42 CFR 438.50(d)	2. Place a check mark to affirm if the state's definition of title V children is determined by:  ___ i. program participation, ___ ii. special health care needs, or <u>X</u> iii. Both
1932(a)(2) 42 CFR 438.50(d)	3. Place a check mark to affirm if the scope of these title V services is received through a family-centered, community-based, and coordinated care system.  <u>X</u> i. yes ___ ii. no
1932(a)(2) 42CFR 438.50 (d)	4. Describe how the state identifies the following groups of children who are exempt from mandatory enrollment: ( <i>Examples: eligibility database, self-identification</i> )  i. Children under 19 years of age who are eligible for SSI under title XVI;  The State identifies this group by Medicaid eligibility category of assistance.  ii. Children under 19 years of age who are eligible under section 1902 (e)(3) of the Act;  The State does not enroll this population in the managed care programs.  iii. Children under 19 years of age who are in foster care or other out-of-home placement;  The State identifies this group by the Medicaid eligibility category of assistance or living arrangement code.  iv. Children under 19 years of age who are receiving foster care or adoption assistance.  The State identifies this group by the Medicaid eligibility category of assistance or living arrangement code.



State: North Carolina

---

Citation	Condition or Requirement
1932(a)(2) 42 CFR 438.50(d)	<p>5. Describe the state's process for allowing children to request an exemption from mandatory enrollment based on the special needs criteria as defined in the state plan if they are not initially identified as exempt. (<i>Example: self-identification</i>)</p> <p>The state has eliminated the self-identification for special needs. Children having special needs are identified according to CFR 438.50(d)(3)</p>
1932(a)(2) 42 CFR 438.50(d)	<p>6. Describe how the state identifies the following groups who are exempt from mandatory enrollments into managed care: (<i>Examples: usage of aid codes in the eligibility system, self-identification</i>)</p> <p>i. Beneficiaries who are also eligible for Medicare.</p> <p>These beneficiaries are identified by Medicaid eligibility category of assistance.</p> <p>ii. Indians who are members of Federally recognized Tribes except when the MCO or PCCM is operated by the Indian Health Service or an Indian Health program operating under a contract, grant or cooperative agreement with the Indian Health Service pursuant to the Indian Self Determination Act; or an Urban Indian program operating under a contract or grant with the Indian Health Service pursuant to title V of the Indian Health Care Improvement Act.</p> <p>There is no eligibility category group designated for the Native American population; they are eligible for Medicaid under existing program aid categories.</p>

---

Citation	Condition or Requirement
42 CFR 438.50	F. <u>List other eligible groups (not previously mentioned) who will be exempt from mandatory enrollment</u>  MQB, RRF/MRF, CAP cases with a monthly deductible, MAF-D, MAF-W, PACE enrollees, and Aliens eligible for emergency Medicaid only are not eligible to enroll.
42 CFR 438.50	G. <u>List all other eligible groups who will be permitted to enroll on a voluntary basis</u>  MPW (Medicaid for Pregnant Women) Benefit Diversion Beneficiaries Beneficiaries with end stage renal disease
1932(a)(4) FR 438.50	H. <u>Enrollment process.</u>  1. Definitions  i. An existing provider recipient relationship is one in which the provider was the main source of Medicaid services for the recipient during the previous year. This may be established through state records of previous managed care enrollment or fee-for-service experience or through contact with the recipient.  ii. A provider is considered to have "traditionally served" Medicaid beneficiaries if it has experience in serving the Medicaid population.
1932(a)(4) 42 CFR 438.50	2. State process for enrollment by default:  Describe how the state's default enrollment process will preserve:  i. The existing provider-beneficiary relationship (as defined in H.1.i).  Caseworkers at the local department of social services are the primary people who provide information about the program to potential enrollees and enroll them into the program.

State: North Carolina

---

Citation

Condition or Requirement

---

The state provides an enrollment form to the county departments of social services. It is required to be completed at enrollment or change of health home. It is signed by the beneficiary or beneficiary's guardian to verify that they were given freedom of choice and the primary care provider listed on the enrollment form is the provider of choice. If the beneficiary provides the name of their chosen health home by phone, the caseworker is permitted to complete the form and file it in the beneficiary's record without signature. The caseworkers in each local county Department of Social Services (DSS) are responsible for auto-assignments on an individual basis when beneficiaries have not selected a provider.

The State assures that default enrollment will be based first upon maintaining existing provider/patient relationships. Income maintenance caseworkers at the local department of social services are primarily responsible for linking beneficiaries to a health home; however, certain DMA staff and designees also have the ability to link beneficiaries. Inquiries are made for potential default enrollment as to current provider-patient relationships when beneficiaries do not select a PCP at the time of the visit. Some beneficiaries, particularly Supplemental Security Income (SSI) beneficiaries, do not visit the social services office for Medicaid application and/or reapplication. In these cases, written materials describing the managed care options are mailed to them along with a deadline for notification of their PCP selection.

Attempts are made to contact beneficiaries by telephone or letter if they do not respond within the time frame; inquiries are made about existing relationships with providers when contact is made. If the beneficiary cannot be contacted, they are auto-assigned and notified of their enrollment and rights. Assignments are based on an historical relationship with a health home. If no relationship can be determined, the beneficiary is assigned to a health home within a 30 mile radius of the beneficiary's residence.

Counties receive a monthly enrollment report that provides the name of the health home. EIS (Eligibility Information System) also maintains a history of enrollment (exemption or health home).

The state allows providers to have their patients complete an enrollment form which is then sent to the county department of social services, DMA managed care staff, or designee for enrollment.

TN No.: 12-022  
Supersedes  
TN No.: 10-035A

Approval Date: 06-12-13

Effective Date: 01/01/2013

State: North Carolina

---

Citation	Condition or Requirement
1932(a)(4) 42 CFR 438.50	<p>The provider is required to provide education about the PCCM program and explain freedom of choice.</p> <p>ii. the relationship with providers that have traditionally served Medicaid beneficiaries (as defined in H.2.ii).</p> <p>Beneficiaries are notified of managed care programs when they apply for Medicaid or when they are due for their eligibility review. Because SSI beneficiaries do not apply for Medicaid, they are listed on a report. When they become eligible for Medicaid, a letter is sent to them asking them to contact DSS to select a PCP. The report is monitored to determine if SSI beneficiaries are getting enrolled.</p> <p>The county DSS staff has the responsibility to review the SSI exempt report and auto-assign all beneficiaries over the age of 19 who have been on the report for 30 days or more. Counties then send a letter to the beneficiary informing them of their PCP along with a copy of the beneficiary handbook.</p> <p>iii. the equitable distribution of Medicaid recipients among qualified MCOs and PCCMs available to enroll them, (excluding those that are subject to intermediate sanction described in 42 CFR 438.702(a)(4)); and disenrollment for cause in accordance with 42 CFR 438.56 (d)(2). <i>(Example: No auto-assignments will be made if MCO meets a certain percentage of capacity.)</i></p> <p>If it is not possible to obtain provider-patient history, beneficiaries are assigned to a health home based upon equitable distribution among participating PCPs available in the beneficiary's county of residence and within a 30 mile radius of the beneficiary's home.</p> <p>Caseworkers are told to look at the provider restrictions, e.g. patients 21 and under or established patients only, listed in the State Eligibility Information System (EIS), and geographical proximity to the provider before auto assigning a beneficiary.</p> <p>3. As part of the state's discussion on the default enrollment process, include the following information:</p>

State: North Carolina

---

Citation	Condition or Requirement
i.	The state will ___/will not <u>X</u> use a lock-in for managed care managed care.
ii.	The time frame for recipients to choose a health plan before being auto-assigned will be 30 days.
iii.	Describe the state's process for notifying Medicaid recipients of their auto-assignment. ( <i>Example: state generated correspondence.</i> )  Beneficiaries are notified of managed care programs when they apply for Medicaid or when they are due for their eligibility review. Because SSI beneficiaries do not apply for Medicaid, they are listed on a report. When they become eligible for Medicaid, a letter is sent to them asking them to contact DSS to select a PCP. The report is monitored to determine if SSI beneficiaries are getting enrolled.  The county DSS staff has the responsibility to review the SSI exempt report and auto-assign all beneficiaries over the age of 19 who have been on the report for 30 days or more. Counties then send a letter to the beneficiary informing them of their PCP along with a copy of the beneficiary handbook.
iv.	Describe the state's process for notifying the Medicaid beneficiaries who are auto-assigned of their right to disenroll without cause during the first 90 days of their enrollment. ( <i>Examples: state generated correspondence, HMO enrollment packets etc.</i> )  The State assures that beneficiaries will be permitted to disenroll from a managed care plan on a month to month basis.
v.	Describe the default assignment algorithm used for auto-assignment. ( <i>Examples: ratio of plans in a geographic service area to potential enrollees, usage of quality indicators.</i> )  Caseworkers at the local DSS are trained to make every effort to support a Provider/ patient relationship with the auto-assignment. If a relationship is not present, caseworkers are instructed to auto-assign beneficiaries to a health home that is accepting new patients within a 30 mile radius. This is done on a case by case basis.

Citation	Condition or Requirement
1932(a)(4) 42 CFR 438.50	<p data-bbox="591 415 1471 506">i. Describe how the state will monitor any changes in the rate of default assignment. (Example: usage of the Medical Management Information System (MMIS), monthly reports generated by the enrollment broker.)</p> <p data-bbox="591 541 1471 625">MMIS produces a monthly provider availability report that is reviewed by the regional managed care consultant to determine if a provider is reaching his or her enrollment limit.</p> <p data-bbox="591 661 1471 720">Caseworkers are instructed to identify on the Medicaid enrollment application when a beneficiary is auto-assigned to a medical home.</p> <p data-bbox="475 751 987 779">I. <u>State assurances on the enrollment process</u></p> <p data-bbox="532 814 1471 873">Place a check mark to affirm the state has met all of the applicable requirements of choice, enrollment, and re-enrollment.</p> <ol data-bbox="532 909 1471 1633" style="list-style-type: none"><li data-bbox="532 909 1471 1024">1. <input checked="" type="checkbox"/> The state assures it has an enrollment system that allows beneficiaries who are already enrolled to be given priority to continue that enrollment if the MCO or PCCM does not have capacity to accept all who are seeking enrollment under the program.</li><li data-bbox="532 1060 1471 1171">2. <input checked="" type="checkbox"/> The state assures that, per the choice requirements in 42 CFR 438.52, Medicaid beneficiaries enrolled in either an MCO or PCCM model will have a choice of at least two entities unless the area is considered rural as defined in 42 CFR 438.52(b)(3).</li><li data-bbox="532 1186 1471 1245">3. <input checked="" type="checkbox"/> The state plan program applies the rural exception to choice requirements of 42 CFR 438.52(a) for MCOs and PCCMs. <p data-bbox="591 1276 1357 1304"><input type="checkbox"/> This provision is not applicable to this 1932 State Plan Amendment.</p></li><li data-bbox="532 1339 1471 1514">4. <input type="checkbox"/> The state limits enrollment into a single Health Insuring Organization (HIO), if and only if the HIO is one of the entities described in section 1932(a)(3)(C) of the Act; and the beneficiary has a choice of at least two primary care providers within the entity. (California only.) <p data-bbox="646 1486 1425 1514"><input checked="" type="checkbox"/> This provision is not applicable to this 1932 State Plan Amendment.</p></li><li data-bbox="532 1549 1471 1633">5. <input type="checkbox"/> The state applies the automatic reenrollment provision in accordance with 42 CFR 438.56(g) if the recipient is disenrolled solely because he or she loses Medicaid eligibility for a period of 2 months or less.</li></ol>

---

Citation	Condition or Requirement
----------	--------------------------

---

X This provision is not applicable to this 1932 State Plan Amendment.

1932(a)(4)  
42 CFR 438.50

J. Disenrollment

1. The state will \_\_\_/will not X use lock-in for managed care.
2. The lock-in will apply for \_\_\_ months (up to 12 months).
3. Place a check mark to affirm state compliance.

X The state assures that recipient requests for disenrollment (with and without cause) will be permitted in accordance with 42 CFR 438.56(c).

4. Describe any additional circumstances of “cause” for disenrollment (if any).

K. Information requirements for beneficiaries

Place a check mark to affirm state compliance.

1932(a)(5)  
42 CFR 438.50  
42 CFR 438.10

X The state assures that its state plan program is in compliance with 42 CFR 438.10(i) for information requirements specific to MCOs and PCCM programs operated under section 1932(a)(1)(A)(i) state plan amendments. (Place a check mark to affirm state compliance.)

1932(a)(5)(D)  
1905(t)

L. List all services that are excluded for each model (MCO & PCCM)

The following PCCM exempt services do not require PCP authorization:

- |                                  |   |
|----------------------------------|---|
| Ambulance                        | Services in hospital Emergency Department |
| Anesthesiology                   | Limited eye care services                 |
| At Risk Case Management          | Family Planning                           |
| CAP Services                     | Head Start Programs                       |
| Certified Nurse Anesthetist      | Hearing Aids                              |
| Dental                           | Hospice                                   |
| CDSAs                            | Laboratory Services                       |
| Mental Health for adults         | Optical Supplies/Visual Aids              |
| Pathology Services               | Pharmacy                                  |
| School Services                  |   |
| Inpatient care with ED admission |   |

---

Citation	Condition or Requirement
1932 (a)(1)(A)(ii)	<p data-bbox="532 422 1170 512">Care Management by CCNC network Services provided by health departments Radiology services billed with Radiologist provider number</p> <p data-bbox="472 541 1084 575">M. <u>Selective contracting under a 1932 state plan option</u></p> <p data-bbox="532 604 1472 663">To respond to items #1 and #2, place a check mark. The third item requires a brief narrative.</p> <ol data-bbox="532 695 1472 999" style="list-style-type: none"><li data-bbox="532 695 1472 756">1. The state will ____/will not <u>X</u> intentionally limit the number of entities it contracts under a 1932 state plan option.</li><li data-bbox="532 787 1472 848">2. ____ The state assures that if it limits the number of contracting entities, this limitation will not substantially impair recipient. access to services.</li><li data-bbox="532 879 1472 940">3. Describe the criteria the state uses to limit the number of entities it contracts under a 1932 state plan option. (<i>Example: a limited number of providers and/or enrollees.</i>)</li><li data-bbox="532 972 1472 999">4. ____ The selective contracting provision in not applicable to this state plan.</li></ol>



State Plan Under Title XIX of the Social Security Act  
Medical Assistance Program  
State: NORTH CAROLINA

Payments for Medical and Remedial Care and Services: Inpatient Hospital

---

## **HOSPITAL INPATIENT REIMBURSEMENT PLAN**

### **REIMBURSEMENT PRINCIPLES**

With respect to hospitals licensed by the State of North Carolina that are qualified to certify public expenditures in accordance with 42 CFR 433.51(b), other than hospitals owned or controlled by the University of North Carolina Health Care System, as defined in N.C. Gen. Stat. 116-37, State hospitals described in Paragraph (b) and hospitals described in Paragraph (a) of the Exceptions to DRG reimbursement and Critical Access Hospitals pursuant to 42 USC 1395i-4, the expenditures claimable for Federal Financial Participation (FFP) will be the hospitals' reasonable costs incurred in serving Medicaid inpatients, as determined in accordance with Medicare principles. Payments to these hospitals will be made in stages (the first stage payment will be based on the DRG methodology applicable to private hospitals; the second stage payment will be for the difference between the hospital's reasonable costs and the first stage payment). Each hospital's allowable inpatient costs will be determined on an interim basis by multiplying the hospital's Medicaid inpatient ratio of cost-to-charges (RCCs), as derived from the hospital's most recent available as-filed CMS 2552 cost report by the hospital's allowable Medicaid inpatient charges for services provided during the same fiscal year as the filed cost report and paid not less than six months after the end of that same fiscal year. This cost data will be brought forward to the mid-point of the period for which FFP is being claimed by applying the applicable CMS PPS Hospital Input Price Indices. Hospitals' final allowable costs for serving Medicaid inpatients will be determined using audited CMS 2552 cost reports for the year for which final FFP is being determined. The difference between the final and interim allowable Medicaid costs will be an adjustment(s) to the applicable period for which the cost was incurred and initial claim was made.

All hospitals that are state-owned and operated by the Department of Health and Human Services, all primary affiliated teaching hospitals for the University of North Carolina Medical Schools, freestanding rehabilitation hospitals that are qualified to certify public expenditures, and Critical Access Hospitals pursuant to 42 USC 1395i-4 will be reimbursed their allowable costs in accordance with the EXCEPTIONS TO DRG REIMBURSEMENT section of this plan.

All other hospitals will be paid for acute care general hospital inpatient services using the DIAGNOSIS RELATED GROUPS (DRG) RATE-SETTING METHODOLOGY described below, except as noted in the EXCEPTIONS TO DRG REIMBURSEMENT. Hospitals that are not qualified to certify public expenditures will also be paid using the enhanced payments for inpatient services methodologies described below.

---

TN. No. 14-013  
Supersedes  
TN. No. 11-003

Approval Date JUN 19 2014

Eff. Date 01/1/2014

State Plan Under Title XIX of the Social Security Act  
Medical Assistance Program  
State: NORTH CAROLINA

Payments for Medical and Remedial Care and Services: Inpatient Hospital

---

---

### **DRG RATE SETTING METHODOLOGY**

(a) Diagnosis Related Groups is a system of classification for hospital inpatient services. For each hospital admission, a single DRG category shall be assigned based on the patient's diagnosis, age, procedures performed, length of stay, and discharge status. For claims with dates of services prior to January 1, 1995 payments shall be based on the reimbursement per diem in effect prior to January 1, 1995. However, for claims related to services where the admission was prior to January 1, 1995 and the discharge was after December 31, 1994, then the greater of the total per diem for services rendered prior to January 1, 1995, or the appropriate DRG payment shall be made.

(b) The Division of Medical Assistance (Division) shall use the DRG assignment logic of the Medicare Grouper to assign individual claims to a DRG category. Medicare revises the Grouper each year in October. The Division shall install the most recent version of the Medicare Grouper implemented by Medicare to be effective October 1 of each following rate year. Effective October 1, 2012, the Division shall install the most recent version of the Medicare Grouper implemented by Medicare to be effective October 1 of each rate year. The initial DRG in Version 12 of the Medicare Grouper, related to the care of premature neonates and other newborns numbered 385 through 391, shall be replaced with the following classifications:

385	Neonate, died or transferred, length of stay less than 3 days
801	Birth weight less than 1,000 grams
802	Birthweight 1,000 – 1,499 grams
803	Birthweight 1,500 – 1,999 grams
804	Birthweight $\geq$ 2,000 grams, with Respiratory Distress Syndrome
805	Birthweight $\geq$ 2,000 grams premature with major problems
810	Neonate with low birthweight diagnosis, age greater than 28 days at admission
389	Birthweight $\geq$ 2,000 grams, full term with major problems
390	Birthweight $\geq$ 2,000 grams, full term with other problems or premature without major problems
391	Birthweight $\geq$ 2,000 grams, full term without complicating diagnoses

Effective October 1, 2008, the premature neonates and other newborn DRGs listed above are replaced by the premature neonates and other newborn DRGs in Version 25 of the Medicare Grouper (i.e. DRGs 789-795).

DRG 789 Neonate, died or transferred, length of stay less than 3 days.

---

TN. No: 12-020  
Supersedes  
TN. No: 08-012

Approval Date:02/05/2013

Eff. Date: 10/01/2012

State Plan Under Title XIX of the Social Security Act  
Medical Assistance Program  
State: NORTH CAROLINA

Payments for Medical and Remedial Care and Services: Inpatient Hospital

---

(c) DRG relative weights are a measure of the relative resources required in the treatment of the average case falling within a particular DRG category. The average DRG weight for all discharges from a particular hospital is known as the Case Mix Index (CMI). The statewide average CMI for all hospitals is utilized for out-of-state providers.

- (1) The Division shall establish relative weights for each utilized DRG based on a recent data set of historical claims submitted for Medicaid recipients. Charges on each historical claim shall be converted to estimated costs by applying the hospital specific cost to charge ratio from each hospital's submitted Medicaid cost report. Cost estimates are standardized by removing direct and indirect medical education costs at the appropriate rates for each hospital.
- (2) Relative weights shall be calculated as the ratio of the average cost in each DRG to the overall average cost for all DRGs combined. Prior to calculating these averages, low statistical outlier claims shall be removed from the data set, and the costs of claims identified as high statistical outlier shall be capped at the statistical outlier threshold. The Division of Medical Assistance shall employ criteria for the identification of statistical outliers which are expected to result in the highest number of DRGs with statistically stable weights.
- (3) The Division of Medical Assistance shall employ a statistically valid methodology to determine whether there are a sufficient number of recent claims to establish a stable weight for each DRG. For DRGs lacking sufficient volume, the Division shall set relative weights using DRG weights generated from the North Carolina Medical Data Base Commission's discharge abstract file covering all inpatient services delivered in North Carolina hospitals. For DRGs in which there are an insufficient number of discharges in the Medical Data Base Commission data set, the Division sets relative weights based upon the published DRG weights for the Medicare program.
- (4) Relative weights shall be recalculated when the new version of the DRG Grouper is installed by the Division of Medical Assistance to be effective October 1 of the rate year. When relative weights are recalculated, the overall average CMI will be kept constant. Then a two and one-tenth percent (2.1%) reduction factor shall be applied uniformly to the case weighting factor assigned to each DRG.

State Plan Under Title XIX of the Social Security Act  
Medical Assistance Program  
State: NORTH CAROLINA

Payments for Medical and Remedial Care and Services: Inpatient Hospital

- (d) The Division of Medical Assistance shall establish a unit value for each hospital which represents the DRG payment rate for a DRG with a relative weight of one. This rate is established as follows:
- (1) Using the methodology described in Paragraph (c) of this plan, the Division shall estimate the cost less direct and indirect medical education expense on claims for discharges occurring during calendar year 1993, using cost reports for hospital fiscal years ending during that period or the most recent cost report available. All cost estimates are adjusted to a common 1994 fiscal year and inflated to the 1995 rate year.  
  
The average cost per discharge for each provider is calculated. (See Exhibit page 25 of the plan). The state reserves the right to rebase based upon a year selected by the state.
  - (2) Using the DRG weights to be effective on January 1, 1995, a CMI is calculated for each hospital for the same population of claims used to develop the cost per discharge amount in Subparagraph (d)(1) of this plan. Each hospital's average cost per discharge is divided by its CMI to get the cost per discharge for a service with a DRG weight of one.
  - (3) The amount calculated in Subparagraph (d)(2) of this plan is reduced by 7.2% to account for outlier payments.
  - (4) For State Fiscal Year ending June 30, 2015, effective January 1, 2015, the individualized base DRG rates for hospital inpatient services are equal to the statewide median rate as of June 30, 2014. All primary affiliated teaching hospitals for the University of North Carolina Medical Schools' base rates shall not be included in the calculation of the statewide median rate and shall have their base rate equal to their respective base rate in effect June 30, 2014. New hospitals inpatient rates will be established based on the statewide median rate. Existing hospitals that enter into a Change of Ownerships (CHOW) shall have the hospital's rates established based on the previous hospital's rates. Critical Access Hospitals' (CAH) rates will be established based on the same hospital's Acute Care Hospital rates. The actual reimbursement amount for a DRG billing is the product of the hospital specific rate times the relative weight and unit value for that DRG exclusive of add-ons (i.e. DSH and outliers).
  - (5) The hospital unit values calculated in Subparagraph (d)(4) of this plan shall be updated annually by the National Hospital Market Basket Index as published by Medicare and applied to the most recent actual and projected cost data available from the North Carolina Office of State Budget, Planning, and Management. This annual update shall not exceed the update amount approved by the North Carolina General Assembly. Effective October 1, 1997, for fiscal year ended September 30, 1998 only the hospital unit values calculated in Subparagraph (d)(4) of this plan shall be updated by the lower of the National Hospital Market Basket Index as published by Medicare and applied to the most recent actual and projected cost data available from the North Carolina Office of State Budget, Planning, and Management or the Medicare approved Inpatient Prospective Payment update factor. Notwithstanding any other provision, if specified, these rates will be adjusted as shown on Attachment 4.19-A, Supplement 1, Page 3 of the Sate Plan.
  - (5) Allowable and reasonable costs will be reimbursed in accordance with the provisions of the Medicare Provider Reimbursement Manual referred to as CMS Publication 15-1.

State Plan Under Title XIX of the Social Security Act  
Medical Assistance Program  
State: NORTH CAROLINA

Payments for Medical and Remedial Care and Services: Inpatient Hospital

---

- (e) Reimbursement for capital expense is included in the DRG hospital rate described in Paragraph (d) of this plan.
- (f) Hospitals operating Medicare approved graduate medical education programs shall receive a DRG payment rate adjustment which reflects the reasonable direct and indirect costs of operating those programs.
- (1) The Division defines reasonable direct medical education costs consistent with the base year cost per resident methodology described in 42 CFR Part 413 Subpart F. The ratio of the aggregate approved amount for graduate medical education costs as determined in accordance with 42 CFR Part 413 Subpart F to total reimbursable costs (per Medicare principles) is the North Carolina Medicaid direct medical education factor. The direct medical education factor is based on information supplied in the 1993 cost reports and the factor will be updated annually as soon as practicable after July 1 based on the latest cost reports filed prior to July 1.
  - (2) Effective October 1, 2001, and for each subsequent year, the North Carolina Medicaid indirect medical education factor is equal to the Medicare indirect medical education factor in effect on October 1 each year.
  - (3) Hospitals operating an approved graduate medical education program shall have their DRG unit values increased by the sum of the direct and indirect medical education factors.
- (g) Cost outlier payments are an additional payment made at the time a claim is processed for exceptionally costly services. These payments shall be subject to retrospective review by the Division of Medical Assistance, on a case-by-case basis. Cost Outlier payments will be reduced if and to the extent that the preponderance of evidence on review supports a determination that the associated cost either exceeded the costs for services that were not medically necessary or was for services not covered by the North Carolina Medical Assistance program.
- (1) A cost outlier threshold shall be established for each DRG at the time DRG relative weights are calculated, using the same information used to establish those relative weights. The cost threshold is the greater of twenty-five thousand dollars (\$25000) or mean cost for the DRG plus 1.96 standard deviations.
  - (2) Charges for non-covered services and services not reimbursed under the inpatient DRG methodology (such as professional fees) shall be deducted from total billed charges. The remaining billed charges are converted to cost using a hospital specific total cost to total charge ratio not from the cost report but developed. The cost to charge ratio excludes medical education costs.
  - (3) If the net cost for the claim exceeds the cost outlier threshold, a cost outlier payment is made at 75% of the costs above the threshold.

State Plan Under Title XIX of the Social Security Act  
Medical Assistance Program  
State: NORTH CAROLINA

Payments for Medical and Remedial Care and Services: Inpatient Hospital

(h) Day outlier payments are an additional payment made for exceptionally long lengths of stay on services provided to children under six at disproportionate share hospitals and children under age one at non-disproportionate share hospitals. These payments shall be subject to retrospective review by the Division of Medical Assistance, on a case-by-case basis. Day outlier payments will be reduced if and to the extent that the preponderance of evidence on review supports a determination that the associated cost either exceeded the costs or was for services that were not medically necessary or for services not covered by the North Carolina Medical Assistance program.

- (1) A day outlier threshold shall be established for each DRG at the time DRG relative weights are calculated, using the same information used to establish the relative weights. The day outlier threshold is the greater of 30 days or the arithmetical average length of stay for the DRG plus 1.50 standard deviations.
- (2) A day outlier per diem payment may be made for covered days in excess of the day outlier threshold at 75% of the hospital's payment rate for the DRG rate divided by the DRG average length stay.

(i) Services which qualify for both cost outlier and day outlier payments under this plan shall receive the greater of the cost outlier or day outlier payment.

(j) Rates established under this Paragraph shall be prospectively determined and shall not be subject to retrospective settlement.

State Plan Under Title XIX of the Social Security Act  
Medical Assistance Program  
State: NORTH CAROLINA

Payments for Medical and Remedial Care and Services: Inpatient Hospital

---

**EXCEPTIONS TO DRG REIMBURSEMENT**

(a) Covered psychiatric and rehabilitation inpatient services provided in either specialty hospitals, Medicare recognized Long Term Acute Care Hospitals (LTCH), Medicare recognized distinct part units (DPU), or other beds in general acute care hospitals shall be reimbursed on a per diem methodology.

(1) Prior to October 1, 2008, psychiatric inpatient services are defined as admissions where the primary reason for admission would result in the assignment of a psychiatric DRG code in the range 424 through 437 and 521 through 523. Effective October 1, 2008, the assignment of a psychiatric DRG code is in the range 880 through 887 or 894 through 897 or 876. All services provided by specialty psychiatric hospitals are presumed to come under this definition.

Prior to October 1, 2008, rehabilitation inpatient services are defined as admissions where the primary reason for admissions would result in the assignment of DRG 462. Effective October 1, 2008, the assignment of a rehabilitation DRG code is 945 or 946. All services provided by specialty rehabilitation hospitals and Medicare recognized Long Term Acute Care Hospitals (LTCH) are presumed to come under this definition.

(2) When a patient has a medically appropriate transfer from a medical or surgical bed to psychiatric or rehabilitative distinct part unit within the same hospital or to a specialty hospital the admission to the distinct part unit or the specialty hospital shall be recognized as a separate service which is eligible for reimbursement under the per diem methodology.

Transfers occurring within general hospitals from acute care services to non-DPU psychiatric or rehabilitation services are not eligible for reimbursement under this Section. The entire hospital stay in these instances shall be reimbursed under the DRG methodology.

(3) The per diem base rate for psychiatric services is established at the lesser of the actual cost or the calculated median rate of all hospitals providing psychiatric services, as derived from the 2003 Medicaid cost report or the most recent as filed cost report, trended forward to the rate year. Providers that routinely provide psychiatric services and whose base rate trended forward to State Fiscal Year 2005 is less than their rate as of October 1, 2004, shall have their base rate established at the October 1, 2004 amount and trended forward in subsequent years.

(4) Hospitals that do not routinely provide psychiatric services shall have their rate set at the median rate for all other psychiatric hospitals in paragraph (3) above.

State Plan Under Title XIX of the Social Security Act  
Medical Assistance Program  
State: NORTH CAROLINA

Payments for Medical and Remedial Care and Services: Inpatient Hospital

- (5) The per diem rate for rehabilitation services is established at the lesser of the actual cost trended to the rate year or the calculated median rate of all hospitals providing rehabilitation services as derived from the most recent filed cost reports.
- (6) Rates established under this Paragraph are adjusted for inflation consistent with the methodology under Subparagraph (d)(5) of the DRG RATE SETTING METHODOLOGY.
- (7) Rates established under this Paragraph shall be prospectively determined and shall not be subject to retrospective settlement.

(b) Hospitals operated by the Department of Health and Human Services, all the primary affiliated teaching hospitals for the University of North Carolina Medical Schools will be reimbursed their reasonable costs in accordance with the provisions of the Medicare Provider Reimbursement Manual. Critical Access Hospital pursuant to 42 USC 1395i-4 will be reimbursed their reasonable costs for acute care services in accordance with the provision of the Medicare Provider Reimbursement Manual. This Manual referred to as (CMS Publication #15-1) is hereby incorporated by reference including any subsequent amendments and editions. Interim payment rates will be estimated by the hospital and provided to the Division of Medical Assistance (DMA) subject to DMA review. These rates will be set at a unit value that can best be expected to approximate 100% of reasonable cost. Interim payments made under the DRG methodology to these providers shall be retrospectively settled to reasonable cost.

(c) Hospitals operating Medicare approved graduate medical education programs shall receive a per diem rate adjustment which reflects the reasonable direct and indirect costs of operating these programs. The per diem rate adjustment will be calculated in accordance with the provisions of DRG Rate Setting Methodology.

---

TN. No. 12-020

Supersedes

Approval Date 02/05/2013

Eff. Date 10/01/2012

TN. No. 05 015

and TN. No. 05-008 with Approval Date: January 17, 2006 and Eff. Date: 6/30/2005

TN. No. 00-03 with Approval Date: December 15, 2005 and Eff. Date: 10/01/2005



State Plan Under Title XIX of the Social Security Act  
Medical Assistance Program

State: NORTH CAROLINA

Payments for Medical and Remedial Care and Services: Inpatient Hospital

---

Payment for Hospital Acquired Conditions:

Effective January 1, 2011 and in accordance with Title XIX of the Social Security Act – Sections 1902, 1903 and 42 CFRs 434, 438, and 447, Medicaid will make no payment to providers for services related to Provider Preventable Conditions (PPC) which includes Healthcare Acquired Condition (HCAC) and Never Events (NE).

In accordance with N.C. State Plan, Attachment 3.1-A, Page 1, Hospital Services payments are allowed except for the following conditions outlined below.

The above effective date and after, for all Medicaid patients, requests for Diagnosis Related Groups (DRGs) attributable to Present on Admission (POA) conditions will be reimbursed for allowable charges. Peer Review Organization (PRO) review for Present on Admission (POA) is not required.

Provider Preventable Conditions (PPC), which includes Healthcare Acquired Condition (HCAC), with diagnose codes with Y or W, or as defined by CMS, will be considered in the DRG calculation. Conversely, any diagnoses codes with N or U, or as defined by CMS, will not be considered in the DRG calculation. Provider Preventable Conditions (PPC) will not be approved by the Peer Review Organization (PRO). Providers must identify and report PPC occurrences.

Never Events (NE) are defined by the National Coverage Determination (NCD) manual for Inpatient Hospitals and practitioners, and these providers will be required to report NEs. Never Events (NE) for Inpatient Hospital claims will bill separate claims using by Bill Type 110 or as designated by the National Uniform Bill Committee for a non-payment/zero claim. The non-covered Bill Type 110 must have one of the ICD-9 diagnosis codes.

- E876.5 – Performance of wrong operation (procedure) on correct patient
- E876.6 – Performance of operation (procedure) on patient not scheduled for surgery
- E876.7 – Performance of correct operation (procedure) on wrong side/body part

The provider may file a separate claim for the same Medicaid recipient with the same dates of service to include the allowable charges for reimbursement. Providers must identify and report NE occurrences.

Prohibition on payments for PPCs, HCACs and NEs shall not result in a loss of access to care or services for Medicaid beneficiaries. This policy applies to all Medicaid reimbursement provisions, contained in 4.19A, including Medicaid supplemental or enhanced payments and Medicaid disproportionate share hospital payments.

State Plan Under Title XIX of the Social Security Act  
Medical Assistance Program  
State: NORTH CAROLINA

Payments for Medical and Remedial Care and Services: Inpatient Hospital

---

## **ENHANCED PAYMENTS FOR INPATIENT HOSPITAL SERVICES**

(e) Hospitals that are licensed by the State of North Carolina, are not qualified to certify expenditures and that received payment for more than 50 percent of their Medicaid inpatient discharges under the DRG methodology for the most recent 12-month period ending September 30, shall be entitled to the following enhanced payments, for inpatient services for the 12-month period ending September 30 of each year, paid annually in up to four installments.

(e.1) Base Enhanced Payment

(1) The base enhanced payment to hospitals shall equal a percent, not to exceed the State's federal financial participation rate in effect for the period for which the payment is being calculated, of the hospital's inpatient "Medicaid deficit." At least 10 calendar days in advance of the first payment of the payment plan year, the Division will determine, and notify eligible hospitals of, the percent of the inpatient "Medicaid deficit" to be paid as the base enhanced payment for inpatient services.

(2) The "Medicaid deficit" is calculated by subtracting Medicaid payments from reasonable Medicaid costs as follows:

(A) Reasonable costs of inpatient hospital Medicaid services including the reasonable direct and indirect costs attributable to inpatient Medicaid services of operating Medicare approved graduate medical education programs shall be determined annually by:

- i. Calculating a hospital's inpatient charge to cost conversion factor, based on the Medicaid per diems and the ancillary cost-to-charge ratios, using the Medicaid cost from the Title XIX D-1, Part II worksheet using the most recent available CMS 2552 cost report,
- ii. Multiplying the Medicaid inpatient charge to cost conversion factor calculated above by the hospital's Medicaid allowable charges for inpatient services provided during the same fiscal year as the filed cost report and paid not less than six months after the end of the fiscal year,
- iii. Applying the applicable CMS PPS Hospital Input Price Indices to bring the cost data forward to the mid-point of the payment period.

(B) Subtracting from the reasonable Medicaid costs for inpatient services, Medicaid payments received (excluding all Medicaid disproportionate share hospital payments received) for the same fiscal year covered by the cost report and the Medicaid allowable charges for inpatient services referred to in 2. A. ii above. The payments shall be brought forward to the end of the payment period using the same percentage by which the Division increased Medicaid DRG and per diem payment rates between the year to which the DRG and per diem payments apply and the payment year for which the enhanced payments are being calculated.

---

TN. No. 14-013  
Supersedes  
TN. No. 11-003

Approval Date JUN 19 2014

Eff. Date 01/1/2014

State Plan Under Title XIX of the Social Security Act  
Medical Assistance Program  
State: NORTH CAROLINA

Payments for Medical and Remedial Care and Services: Inpatient Hospital

---

(e.2) Equity Enhanced Payments

- (1) The Equity enhanced payment shall, when added to the Base enhanced payment described above in this Section equal one hundred percent of the hospital's inpatient "Medicaid deficit".
- (2) Assessments collected under this section are considered an allowable cost and are not subject to cost settlement.

---

TN. No. 11-003  
Supersedes  
TN. No. 06-008

Approval Date 03/26/2012

Eff. Date 1/1/2011

State Plan Under Title XIX of the Social Security Act  
Medical Assistance Program  
State: NORTH CAROLINA

Payments for Medical and Remedial Care and Services: Inpatient Hospital

---

**ENHANCED PAYMENTS TO TEACHING HOSPITALS FOR INPATIENT HOSPITAL SERVICES**

(f) Hospitals that are not qualified to certify public expenditures, are licensed by the State of North Carolina, qualify for disproportionate share hospital status under Paragraph (c) of this Section, and, for the fiscal year immediately preceding the period for which payments under this Paragraph are being calculated:

- i. Qualify to receive inpatient hospital rate adjustment payments described in Paragraph (g) of the section of this plan entitled “INPATIENT HOSPITAL RATE ADJUSTMENT PAYMENT TO HOSPITALS SERVING HIGH PORTIONS OF LOW INCOME PATIENTS;” and
  - ii. Operate at least two Medicare approved graduate medical education programs and report on cost reports filed with the Division, Medicaid costs attributable to such programs shall be entitled to additional enhanced payments for inpatient services paid annually in up to four installments.
- (1) The additional enhanced payment for Medicaid inpatient services shall satisfy the portion of the inpatient “Medicaid deficit” equal to 7.22 percent of the hospital’s estimated uncompensated care cost of providing inpatient and outpatient services to uninsured.
- (2) The “Medicaid deficit” shall be calculated by subtracting Medicaid payments from reasonable Medicaid costs as follows:
- (A) Reasonable costs of inpatient hospital Medicaid services including the reasonable direct and indirect costs attributable to inpatient Medicaid services of operating Medicare approved graduate medical education programs shall be determined annually by:
- i. Calculating a hospital’s Medicaid inpatient cost-to-charge ratio using the most recent available as-filed CMS 2552 cost report,
  - ii. Multiplying the Medicaid inpatient cost-to-charge ratio by the hospital’s Medicaid allowable inpatient charges for inpatient services provided during the same fiscal year as the filed cost report, and paid not less than six months after the end of the fiscal year,
  - iii. Applying the applicable CMS PPS Hospital Input Price Indices to bring the cost data forward to the mid-point of the payment period.

State Plan Under Title XIX of the Social Security Act  
Medical Assistance Program  
State: NORTH CAROLINA

Payments for Medical and Remedial Care and Services: Inpatient Hospital

---

- (B) Subtracting from the reasonable Medicaid costs for inpatient services, Medicaid payments received (excluding all Medicaid disproportionate share hospital payments received) for the same fiscal year covered by the cost report and the Medicaid allowable charges for inpatient services referred to in 2.A.i and ii above. The payments shall be brought forward to the mid-point of the payment period using the same percentage by which the State increased Medicaid DRG and per diem payment rates between the year to which the DRG and per diem payments apply and the payment year for which the enhanced payments are being calculated.
- (3) Uncompensated care costs are calculated using hospitals' gross charges for services provided to uninsured patients as filed with and certified to the Division for the same fiscal year as the CMS cost report used in determining reasonable costs in 2. A. i and ii above. The Division shall convert hospitals' gross charges for uninsured patients to costs by multiplying them by the facility cost-to-charge ratio determined using hospitals' CMS 2552 cost reports for the same fiscal year used in determining reasonable cost in 2.A. i through ii above and then subtracting payments hospitals received from uninsured patients.
- (4) Payments calculated under Paragraph (f) (when added to Medicaid payments received or to be received for these services) shall not cause aggregate payments to any category of hospitals as specified in 42 CFR 447.272(a) to exceed the maximum allowed aggregate upper limits for that category established by applicable federal law and regulation.
- (5) The payments authorized under Paragraph (f) shall be effective in accordance with GS 108A-55(c).

State Plan Under Title XIX of the Social Security Act  
Medical Assistance Program  
State: NORTH CAROLINA

Payments for Medical and Remedial Care and Services: Inpatient Hospital

---

**Inpatient Hospital Rate Adjustment Payment to Hospitals Serving High Portions of Low Income Patients**

(g) Hospitals that are not qualified to certify public expenditures, that are not Critical Access Hospitals pursuant to 42 USC 1395i-4, and that, based on the most recent fiscal year data available at the time of data collection, qualify for disproportionate share status under Paragraph (c) of the “Disproportionate Share Hospital Payment” section of this plan and meet at least one of the criteria outlined in Subparagraphs (d)(1) through (4) of the disproportionate share hospital payment section of this plan shall receive an inpatient rate adjustment payment for the 12-month period ending September 30 each year. This inpatient rate adjustment payment shall be calculated annually and paid monthly. The rate adjustment is equal to 2.5 percent plus one fourth of one percent for each percentage point that the hospital’s Medicaid inpatient utilization rate exceeds one standard deviation of the mean Medicaid inpatient utilization rate in the state. The rate adjustment payment shall be calculated as follows:

- i. For Medicaid inpatient cases paid on a per case basis under the DRG methodology, the Division will multiply the Medicaid inpatient unit or hospital-specific payment rate in effect for the period for which the rate adjustment applies, by each eligible hospital’s DRG case-mix index for Medicaid inpatients served during the most recent 12-month period available before the rate adjustment payment is calculated. The Division will then multiply each hospital’s case-mix adjusted per case payment amount by its rate adjustment, and then multiply this product by the hospital’s total number of Medicaid inpatient cases for the most recent 12-month period available before the rate adjustment payment is calculated.
- ii. For Medicaid inpatient cases paid on a per diem basis, the Division will multiply the Medicaid inpatient per diem payment in effect for the period for which the rate adjustment applies by each hospital’s rate adjustment. The Division will then multiply each hospital’s adjusted per diem payment amount by the hospital’s Medicaid inpatient days for the most recent 12-month period available before the rate adjustment payment is calculated.

Payments calculated under Paragraph (g) (when added to Medicaid payments received or to be received for these services) shall not cause aggregate payments to any category of hospitals as specified in 42 CFR 447.272(a) to exceed the maximum allowed aggregate upper limits for that category established by applicable federal law and regulation.

State Plan Under Title XIX of the Social Security Act  
Medical Assistance Program  
State: NORTH CAROLINA

Payments for Medical and Remedial Care and Services: Inpatient Hospital  
University of North Carolina Hospital Adjustment

---

(h) In addition to the payments made elsewhere in this plan, hospitals owned or controlled by the University of North Carolina Health Care System, as defined in N.C. Gen. Stat. § 116-37, are eligible for a supplemental payment for inpatient hospital services. For a hospital eligible under this Paragraph, the payment in this Paragraph supersedes the requirement, in the REIMBURSEMENT PRINCIPLES and in Paragraph (b) of this Section, that such a hospital be paid allowable costs.

The total payment available for hospitals eligible under this Paragraph will be determined by aggregating the difference between what Medicare would pay for each eligible hospital's Medicaid fee-for-service reimbursement as otherwise calculated under this State Plan. For purposes of calculating this difference, each unit in a hospital with a different Medicare payment system (e.g. acute, psychiatric, rehabilitation) will be treated separately. The difference between what Medicare would pay and inpatient Medicaid payments will be calculated as follows (for exact calculations and cost report references, refer to Exhibit 1, 4.19 –A, page 19):

(1) Using the most current available Medicare cost report data, Medicare payments to each hospital shall be divided into Medicare Payments Subject to the Case Mix Index (including base rate, IME, DSH, high percentage of ESRD beneficiary discharges, capital payments, and SCH or MDH payments), Medicare Payments Not Subject to the Case Mix Index (including GME, organ acquisition, costs associated with teaching physicians, and routine service and other ancillary pass-through payments) and outlier payments.

(2) Medicare Payments Subject to the Case Mix Index shall be divided by the transfer-adjusted Medicare case mix index for the hospital, obtained from the Medicare PS&R for the appropriate time period, to obtain Case Mix Adjusted Medicare Payments Subject to the Case Mix Index.

(3) An Outlier Adjustment will be computed by applying the percentage of Medicaid payments from the Medicaid PS&R that are attributable to outlier payments to the total Medicare Payments Not Subject to the Case Mix Index.

(4) The Outlier Adjustment and Case Mix Adjusted Medicare Payments Subject to the Case Mix Index shall be added to Medicare Payments Not Subject to the Case Mix Index to obtain Case Mix Adjusted Medicare Payments.

(5) Case Mix Adjusted Medicare Payments shall be divided by the number of Medicare discharges (from the Medicare cost report) to obtain the Adjusted Medicare Payments Per Discharge. The Adjusted Medicare Payment Per Discharge shall be inflated into the current year using the CMS PPS hospital market basket index.

(6) The Medicaid Payment Per Discharge shall be calculated using data from a Medicaid PS&R for the same year as the Medicare cost report and run no less than nine (9) months after the close of the cost report year. Total Medicaid Inpatient Fee-For-Service Payments from the Medicaid PS&R shall be divided by Total Medicaid Discharges from the Medicaid PS&R to obtain the Unadjusted Medicaid Payment Per Discharge.

(7) The Unadjusted Medicaid Payment Per Discharge shall be divided by the Case Mix Index for the Medicaid population calculated using MMIS data to obtain the Adjusted Medicaid Payment Per Discharge. The Adjusted Medicaid Payment Per Discharge shall be inflated into the current year using the CMS PPS hospital market basket index.

(8) The inflated Adjusted Medicaid Payment Per Discharge shall be subtracted from the inflated Adjusted Medicare Payment Per Discharge to obtain the Per Discharge Differential.

(9) The Per Discharge Differential shall be multiplied by the Case Mix Index for the Medicaid population and Total Medicaid Discharges to calculate the Available Room Under the UPL.

(10) The Available Room Under the UPL for each eligible hospital will be aggregated to create the Supplemental Payment Amount. The total calculated Supplemental Payment Amount will be paid to eligible hospitals in payments made no more frequently than each quarter.

If payments in this section would result in payments to any category of hospitals in excess of the upper payment limit calculation required by 42 C.F.R. 447.272, payments for each eligible hospital receiving payments under this section will be reduced proportionately to ensure compliance with the upper payment limit.

State Plan Under Title XIX of the Social Security Act  
Medical Assistance Program  
State: NORTH CAROLINA

Payments for Medical and Remedial Care and Services: Inpatient Hospital

---

---

**Upper Payment Limit Payment for Inpatient Services (Private Hospitals)**

(i) In addition to the payments made elsewhere in this plan, except for hospitals owned or controlled by the University of North Carolina Health Care System, as defined in N.C. Gen. Stat. §116-37, hospitals that are not qualified to certify public expenditures and are licensed by the State of North Carolina that received payment for more than 50 percent of their Medicaid inpatient discharges under per discharge DRG methodology for the most recent 12-month period ending September 30, are eligible for a supplemental payment for inpatient hospital services (the “UPL Payment”) that is calculated annually and paid in up to four (4) installments. The UPL Payment for each hospital shall equal that hospital’s Medicaid Inpatient costs times a fraction, the numerator of which is the aggregate UPL Payment for all hospitals qualified to receive payments under this section and the denominator of which is the aggregate Medicaid Inpatient costs for all such hospitals. Medicaid inpatient costs are the reasonable costs of inpatient hospital services as defined in Section (e.1)(2)(A) of this Attachment 4.19-A. The aggregate UPL Payment for all hospitals qualified to receive payments under this section will be determined by adding for each hospital the difference between what Medicare would pay for the hospital’s Medicaid fee-for-service inpatient services and the hospital’s Medicaid inpatient costs. The amount that Medicare would pay shall be calculated as follows (for exact calculations and cost report references, refer to Exhibit 1, 4.19 –A, page 19):

(1) Using the most current available Medicare cost report data, Medicare payments to each hospital shall be divided into Medicare Payments Subject to the Case Mix Index (including base rate, IME, DSH, high percentage of ESRD beneficiary discharges, capital payments, and SCH or MDH payments), Medicare Payments Not Subject to the Case Mix Index (including GME, organ acquisition, costs associated with teaching physicians and routine service and other ancillary pass-through’s) and outlier payments.

(2) Medicare Payments Subject to the Case Mix Index shall be divided by the transfer-adjusted Medicare case mix index for the group, obtained from the Medicare Case Mix Index published by CMS for the appropriate time period, to obtain Medicare Payments without the Case Mix Index adjustment.

(3) An Outlier Adjustment will be computed by applying the percentage of Medicaid payments from the Medicaid PS&R that are attributable to outlier payments to the total Medicare Payments Not Subject to the Case Mix Index.

(4) The Outlier Adjustment and Medicare Payments without the Case Mix Index adjustment shall be added to Medicare Payments Not Subject to the Case Mix Index for the group to obtain Base Medicare Payments.

(5) Base Medicare Payments for the group shall be divided by the number of Medicare discharges (from the Medicare cost report) to obtain the Base Medicare Payments Per Discharge. The Base Medicare Payment Per Discharge shall be inflated into the current year using the CMS PPS hospital market basket index.

(6) The inflated Base Medicare Payment Per Discharge shall be multiplied by the Case Mix Index for the hospital’s Medicaid population times the hospital’s current year Medicaid Discharges to calculate what Medicare would pay.

If payments in this section would result in payments to all hospitals qualified to receive payments under this section in excess of the upper payment limit calculation required by 42 C.F.R. 447.272, payments for each eligible hospital receiving payments under this section will be reduced proportionately to ensure compliance with the upper payment limit.

Assessments collected under this section are considered an allowable cost and are not subject to cost settlement.



State Plan Under Title XIX of the Social Security Act  
Medical Assistance Program  
State: NORTH CAROLINA

Payments for Medical and Remedial Care and Services: Inpatient Hospital

---

---

**Upper Payment Limit Payment for Inpatient Services (Non-State Governmental Hospitals)**

(j) In addition to the payments made elsewhere in this plan, except for hospitals owned or controlled by the University of North Carolina Health Care System, as defined in N.C. Gen. Stat. §116-37, hospitals that are qualified to certify public expenditures and are licensed by the State of North Carolina that received a first-stage interim payment for more than 50 percent of their Medicaid inpatient discharges under per discharge DRG methodology for the most recent 12-month period ending September 30, are eligible for a supplemental payment for inpatient hospital services (the “UPL Payment”) that is calculated annually and paid in up to four (4) installments. The UPL Payment for each hospital shall equal that hospital’s Medicaid Inpatient costs times a fraction, the numerator of which is the aggregate UPL Payment for all hospitals qualified to receive payments under this section and the denominator of which is the aggregate Medicaid Inpatient costs for all such hospitals. Medicaid inpatient costs are the reasonable costs of inpatient hospital services as defined in Section (e)(2)(A) of this Attachment 4.19-A. The aggregate UPL Payment for all hospitals qualified to receive payments under this section will be determined by adding for each hospital the difference between what Medicare would pay for the hospital’s Medicaid fee-for-service inpatient services and the hospital’s Medicaid inpatient costs. The amount that Medicare would pay shall be calculated as follows (for exact calculations and cost report references, refer to Exhibit 1, 4.19 –A, page 19):

(1) Using the most current available Medicare cost report data, Medicare payments to each hospital shall be divided into Medicare Payments Subject to the Case Mix Index (including base rate, IME, DSH, high percentage of ESRD beneficiary discharges, capital payments, and SCH or MDH payments), Medicare Payments Not Subject to the Case Mix Index (including GME, organ acquisition, costs associated with teaching physicians and routine service and other ancillary pass-through’s) and outlier payments.

(2) Medicare Payments Subject to the Case Mix Index shall be divided by the transfer-adjusted Medicare case mix index for the group, obtained from the Medicare Case Mix Index published by CMS for the appropriate time period, to obtain Medicare Payments without the Case Mix Index adjustment.

(3) An Outlier Adjustment will be computed by applying the percentage of Medicaid payments from the Medicaid PS&R that are attributable to outlier payments to the total Medicare Payments Not Subject to the Case Mix Index.

(4) The Outlier Adjustment and Medicare Payments without the Case Mix Index adjustment shall be added to Medicare Payments Not Subject to the Case Mix Index for the group to obtain Base Medicare Payments.

(5) Base Medicare Payments for the group shall be divided by the number of Medicare discharges (from the Medicare cost report) to obtain the Base Medicare Payments Per Discharge. The Base Medicare Payment Per Discharge shall be inflated into the current year using the CMS PPS hospital market basket index.

(6) The inflated Base Medicare Payment Per Discharge shall be multiplied by the Case Mix Index for the hospital’s Medicaid population times the hospital’s current year Medicaid Discharges to calculate what Medicare would pay.

If payments in this section would result in payments to all hospitals qualified to receive payments under this section in excess of the upper payment limit calculation required by 42 C.F.R. 447.272, payments for each eligible hospital receiving payments under this section will be reduced proportionately to ensure compliance with the upper payment limit.

Assessments collected under this section are considered an allowable cost and are not subject to cost settlements.

State Plan Under Title XIX of the Social Security Act  
Medical Assistance Program

State: NORTH CAROLINA

Payments for Medical and Remedial Care and Services: Inpatient Hospital

---

### **DISPROPORTIONATE SHARE HOSPITAL (DSH) PAYMENT**

With respect to hospitals that are licensed by the State of North Carolina, that are qualified to certify public expenditures (CPEs) and do certify in accordance with 42 CFR 433.51(b), that qualify for disproportionate share hospital status under Paragraph (c) of the "Disproportionate Share Hospital Payment" Section and that do not meet the criteria described in Subparagraph (d)(5) of the "Disproportionate Share Hospital Payment" Section, the expenditures claimable for Federal Financial Participation (FFP) for the 12-month period ending September 30 each year will be (i) the hospitals' uncompensated care expenditures for serving uninsured patients up to the State's available DSH allotment after allowing for DSH payments for the State-owned Institutes for Mental Diseases, Division of Vocational Rehabilitation Services DSH, Basic DSH, HMO DSH, and Teaching Hospital DSH; plus (ii) the State's expenditures for Medicaid Health Maintenance Organization (HMO) DSH payments as described below; plus (iii) Division of Vocational Rehabilitation Services' DSH expenditures as described below. Each hospital's allowable uncompensated care costs for the rate year will be determined on an interim basis by calculating the hospital's inpatient and outpatient cost-to-charge ratios determined from the hospitals' most recent available as-filed CMS 2552 cost report and multiplying the ratios by the hospital's inpatient and outpatient charges, respectively, for uninsured patients as filed with and certified to the Division for the fiscal year. The Division will then subtract payments hospitals received from uninsured patients for services rendered during the fiscal period to which the gross charges referred to in the preceding sentence relate. The Division will bring the uncompensated care cost data forward to the end of the payment period by applying the applicable CMS PPS Hospital Input Price Indices. Hospitals' final allowable costs for services provided to uninsured patients will be determined in accordance with Medicare cost principles by using the hospitals' routine per diems and ancillary cost-to-charge ratios for inpatient cost and outpatient cost-to-charge ratios for outpatient costs from audited CMS 2552 cost reports for the year for which final FFP is being determined by hospitals' inpatient and outpatient charges, respectively, for uninsured patients as filed with and certified to the Division for the same fiscal year and then subtracting payments hospitals received from uninsured patients for services rendered during the fiscal year. The difference between the final and interim allowable Medicaid costs will be an adjustment(s) to the applicable period for which the cost was incurred and initial claim was made. Final cost is determined in accordance with Attachment A beginning on page 19c of this section.

(a) In accordance with the Social Security Act, Title XIX, Section 1923(g)(1) total disproportionate share payments to a hospital shall not exceed the percentage specified by the Social Security Act, Title XIX, Section 1923(g) of the total costs of providing inpatient and outpatient services to Medicaid and uninsured patients for the fiscal year in which such payments are made, less all payments received for services to Medicaid and uninsured patients. The total of all disproportionate share hospital payments shall not exceed the limits on disproportionate share hospital funding as established for this State by CMS in accordance with the provisions of the Social Security Act, Title XIX, Section 1923(f).

(b) The payments authorized by this section shall be effective in accordance with GS 108A-55(c).

State Plan Under Title XIX of the Social Security Act  
Medical Assistance Program  
State: NORTH CAROLINA

Payments for Medical and Remedial Care and Services: Inpatient Hospital

---

---

- (c) No hospital may receive disproportionate share hospital payments unless it:
- (1) Has a Medicaid inpatient utilization rate of not less than one percent, defined as the percentage resulting from dividing Medicaid patient days by total patient days, based on the most current available information; and
  - (2) Has at least two obstetricians with staff privileges at the hospital who have agreed to provide obstetric services to individuals eligible for Medicaid. In the case of a hospital located in a rural area, the term obstetrician includes any physician with staff privileges at the hospital to perform non-emergency obstetric services procedures. This requirement does not apply to a hospital which did not offer non-emergency obstetric services as of December 21, 1987 or to a hospital that predominantly serves individuals under 18 years of age.
- (d) The following Subparagraphs describe additional criteria, at least one of which a hospital must meet to be eligible for disproportionate share hospital payments under certain paragraphs of this Section, as specified in those paragraphs.
- (1) The hospital's Medicaid inpatient utilization rate is at least one standard deviation above the mean Medicaid inpatient utilization rate for all hospitals that receive Medicaid payments in the state; or
  - (2) The hospital's low income utilization rate exceeds 25 percent. The low-income utilization rate is the sum of:
    - (A) The ratio of the sum of Medicaid net revenues for patient services plus cash subsidies received from the State and local governments divided by the hospital's net patient revenues; and
    - (B) The ratio of the hospital's gross inpatient charges for charity care less the cash subsidies for inpatient care received from the State and local governments, divided by the hospital's total inpatient charges; or
  - (3) The sum of the hospital's total Medicaid gross revenues, bad debts allowance net of recoveries, and charity care exceeds 20 percent of total gross patient revenues; or
  - (4) The hospital, in ranking of hospitals in the state from most to least in number of Medicaid patient days provided, is among the top group that accounts for 50 percent of the total Medicaid patient days provided by all hospitals in the state; or
  - (5) The hospital is a Psychiatric Hospital operated by the North Carolina Department of Health and Human Services, Division of Mental Health, Developmental Disabilities, Substance Abuse Services (DMH/DD/SAS) or a hospital owned or controlled by the University of North Carolina Health Care System (UNCHCS), as defined in N.C. Gen. Stat. § 116-37.

State Plan Under Title XIX of the Social Security Act  
Medical Assistance Program  
State: NORTH CAROLINA

Payments for Medical and Remedial Care and Services: Inpatient Hospital

---

---

### **BASIC DISPROPORTIONATE SHARE HOSPITAL (DSH) PAYMENT**

- (e) Each hospital that qualifies for disproportionation share status under Paragraph (c) of the "Disproportionate Share Hospital Payment" section of this plan and (i) is described in subparagraph (d)(5) of the DISPROPORTIONATE SHARE HOSPITAL section of this plan, except for hospitals owned or controlled by the University of North Carolina Health Care System (UNCHCS), as defined in N.C. Gen. Stat. § 116-37; (ii) is a Critical Access Hospital pursuant to 42 USC 1395i-4 that is not qualified to certify public expenditures or a hospital owned or controlled by UNCHCS that meets at least one of the criteria outlined in subparagraphs (d)(1)-(4) of the DISPROPORTIONATE SHARE HOSPITAL section of this plan; (iii) prior to October 1, 2006, meets at least one of the criteria outlined in subparagraphs (d) (1)-(4) of the DISPROPORTIONATE SHARE HOSPITAL section of this plan and is qualified to certify public expenditures but does not certify; or (iv) Effective October 1, 2006, meets at least one of the criteria outlined in subparagraphs (d)(1)-(4) of the DISPROPORTIONATE SHARE HOSPITAL section of this plan and is qualified to certify public expenditures, shall receive a payment for the 12-month period ending September 30 each year, that is calculated annually and paid monthly. The basic DSH rate adjustment is equal to 2.5 percent plus one fourth of one percent for each percentage point that the hospital's Medicaid inpatient utilization rate exceeds one standard deviation of the mean Medicaid inpatient utilization rate in the state. The basic DSH payment shall be calculated as follows:
- (1) For Medicaid inpatient cases paid on a per case basis under the DRG system, the Division will multiply the Medicaid inpatient unit or hospital-specific payment rate in effect for the period for which the basic DSH payment applies, by each eligible hospital's DRG case-mix index for Medicaid inpatients served during the most recent 12-month period available before the rate adjustment payment is calculated. The Division will then multiply each hospital's case-mix adjusted per case payment amount by its basic DSH rate adjustment, and then multiply this product by the hospital's total number of Medicaid inpatient cases for the most recent 12-month period available before the basic DSH payment is calculated.
  - (2) For Medicaid inpatient cases paid on a per diem basis, the Division will multiply the Medicaid inpatient per diem payment in effect for the period for which the basic DSH payment applies, by each hospital's basic DSH rate adjustment. The Division will then multiply each hospital's adjusted per diem payment amount by the hospital's Medicaid inpatient days for the most recent 12-month period available before the basic DSH payment is calculated.

If a payment to a hospital under this section would cause a hospital to exceed the hospital-specific limits on disproportionation share hospital payments at 42 U.S.C. § 1396r-4(g)(1)(A), payments under this section will be reduced to ensure compliance with the hospital-specific limit.

State Plan Under Title XIX of the Social Security Act  
Medical Assistance Program  
State: NORTH CAROLINA

Payments for Medical and Remedial Care and Services: Inpatient Hospital

---

**STATE-OWNED INSTITUTIONS FOR MENTAL DISEASES DSH PAYMENT**

(f) Hospitals operated by the Department of Mental Health that qualify for disproportionate share hospital status under Subparagraph (d)(5) will be eligible for disproportionate share payments, in addition to other payments made under the North Carolina Medicaid Hospital reimbursement methodology, based on bed days of service to low income persons.

- (1) Payment shall equal the facility-specific average per diem cost from its most recent cost report available at the time of data collection multiplied by bed days of service to low income persons.
- (2) “Bed days of service to low income persons” is defined as the number of bed days provided to individuals that have been determined by the hospital as:
  - i. Patients who do not possess the financial resources to pay portions or all charges associated with care provided; and
  - ii. Who do not possess health insurance which would apply to the service for which the individual sought treatment; or
  - iii. Who have insurance but are not covered for the particular service rendered or for the procedure or treatment.
- (3) Payments to Institutes for Mental Diseases under Paragraph (f) shall not exceed the State’s DSH limit for Institutes for Mental Disease.

---

TN. No: 10-001  
Supersedes  
TN. No: 08-012

Approval Date: 04-08-10

Eff. Date 01/08/10

State Plan Under Title XIX of the Social Security Act  
Medical Assistance Program  
State: NORTH CAROLINA

Payments for Medical and Remedial Care and Services: Inpatient Hospital

---

Audit of Disproportionate Share Payments:

As required by Section 1923(j) of the Social Security Act related to auditing and reporting of disproportionate share hospital payments, the Division of Medical Assistance will implement procedures to comply with the Disproportionate Share Hospital Payments final rule issued in the December 19, 2008, Federal Register, with effective date of January 19, 2009, to ensure that the hospital specific DSH limits have not been exceeded.

Any funds recouped as a result of audits or other corrections shall be redistributed to other eligible hospitals within the state, provided each hospital remains below their hospital specific DSH limit. Funds shall be redistributed to the state hospital with the highest Medicaid Inpatient Utilization Rate (MIUR). Any remaining funds available for redistribution shall be redistributed first to other state hospitals in the order of MIUR from highest to lowest, then to government non-state hospitals in the order of MIUR from highest to lowest, then to private hospitals in the order of MIUR from highest to lowest.

---

TN. No. 10-028  
Supersedes  
TN. No. 05-015

Approval Date: 02/02/2011

Eff. Date 10/01/2010

State Plan Under Title XIX of the Social Security Act  
Medical Assistance Program  
State: NORTH CAROLINA

Payments for Medical and Remedial Care and Services: Inpatient Hospital

Exhibit 1

This exhibit contains a table which defines the calculation and source documents for the adjustments based on the difference between what Medicare would pay and inpatient Medicaid payments as otherwise calculated under this state. All cost report line references are based upon the Medicare Cost Report (MCR) CMS 2552 - 10 and should be adjusted for any CMS approved successor Medicare Cost Report (MCR). Table 1 identifies the calculation for acute care hospitals, excluding any psychiatric and rehabilitation distinct part units.

Table 1

Hospital – Specific UPL Calculation – per case method; inpatient only	Data Source: MCR – 2552 – 10 or its successor; if a calculation, defines the line(s) and operation; other documents.	
Step 1: Find the Medicare per case rate with case mix removed.	Include all Medicare payments from the most recent as filed cost report.	
<b>1. Portions of Medicare payments for most recent year subject to Case Mix Index.</b>		
a. Other than Outlier payments (base rate)	Wksht E; Part A; Line 1 (may be total of a number of lines)	\$
b. IME Adjustment	Wksht E; Part A; Line 29	\$
c. DSH Adjustment (include Medicare DSH)	Wksht E; Part A; Line 34	\$
d. Total Uncompensated Care	Wksht E; Part A; Line 36	\$
e. Additional payment for high percentage of ESRD Beneficiary Discharges	Wksht E, Part A; Line 46	\$
f. Capital Adjustment	Wksht E; Part A; Line 50	\$
g. SCH or MDH Hospital Payment	Wksht E; Part A; Line 48	\$
h. Total Medicare payments subject to case mix index	Total lines 1a through 1g	\$
<b>2. Adjustment for Case Mix Index.</b>		
a. Medicare Case Mix Index	From the CMS website for the MCR period	0.0000
b. Case mix adjusted total payments	Line 1h ÷ 2a	\$
<b>3. Medicare Payments not subject to case mix index.</b>		
a. GME adjustment	Wksht E; Part A; Line 52	\$
b. Organ Acquisition cost	Wksht E; Part A; Line 55	\$
c. Cost of Teaching Physicians	Wksht E; Part A; Line 56	\$
d. Routine service pass-through	Wksht E; Part A; Line 57	\$

State Plan Under Title XIX of the Social Security Act  
Medical Assistance Program  
State: NORTH CAROLINA

Payments for Medical and Remedial Care and Services: Inpatient Hospital

Exhibit 1 Continued	Table 1 Continued	
e. Other ancillary other pass-through	Wksht E; Part A; Line 58	\$
f. Exception Payment for IP Program Capital	Wksht E; Part A; Line 51	\$
g. Special Add-On for New Technologies	Wksht E, Part A, Line 54	\$
h. Nursing and Allied Health Managed Care Payment	Wksht E; Part A; Line 53	\$
i. Manufacturer Credit on Replacement Devices	Wksht E; Part A; Line 68	\$
j. Total Medicare payments not subject to case mix index	Total lines 3a through 3i	\$
4. Total Medicare payment with case mix removed and outliers omitted	Line 2b + Line 3j	\$
5. Medicaid Outlier Payment Adjustment		
a. Total Medicaid Outlier Pymts	Medicaid PS&R and Fiscal Agent	\$
b. Total inpatient Medicaid payments included on the Medicaid PS&R	Medicaid PS&R	\$
c. Percentage of Medicaid Outlier Payments to Total Medicaid Payments exclusive of outliers	Line 5a ÷ (Line 5b – Line 5a)	0.00%
6. Calculation of Medicare payment including Medicaid Outlier Payment Adjustment	Line 4 x (1+Line 5c)	\$
7. Calculate per case payment		
a. Medicare Discharges	From MCR	0000
b. Per case Medicare rate with case mix removed.	Line 6 ÷ Line 7a	\$
c. CMS supplied inflation factor 2009	CMS website; Market Basket Data	0.00%
d. CMS supplied inflation factor 2010	CMS website; Market Basket Data	0.00%
e. Inflation adjusted per case Medicare rate with case mix removed.	Line 7b x Line 7c x Line 7d	\$
Step 2. Find the Medicaid per case rate with case mix removed.	Include all Medicaid payments made directly by the Medicaid agency (i.e. exclude Medicaid managed care)	
8. Medicaid Rate per case		
a. Total Medicaid inpatient FFS payments (exclude DSH)	Medicaid PS&R and Fiscal Agent	\$
b. Number of Medicaid Cases	Medicaid PS&R	0000
c. Rate per case	Line 8a ÷ Line 8b	\$



State Plan Under Title XIX of the Social Security Act  
Medical Assistance Program  
State: NORTH CAROLINA

Payments for Medical and Remedial Care and Services: Inpatient Hospital

Exhibit 1 Continued

Table 1 Continued

9. Adjusted for Case Mix		
a. Medicaid case mix	Annual Medicaid Calculation for Recalibration of DRG Weights	0.000
b. Medicaid rate per case with case mix removed	Line 8c ÷ Line 9a	\$
c. CMS supplied inflation factor 2009	CMS website; Market Basket Data	0.00%
d. CMS supplied inflation factor 2010	CMS website; Market Basket Data	0.00%
e. Inflation adjusted per case Medicaid rate with case mix removed	Line 9b x Line 9c x Line 9d	\$
Step 3: Calculate UPL Gap		
10. Per Case Differential from Medicare Payments	Line 7e – Line 9e	\$
11. Per Case differential adjusted for Medicaid case Mix	Line 10 x Line 9a	\$
12. Available Room under UPL for UPL payment	Line 11 x Line 8b	\$

Exhibit 1 – Notes

General Notes for Tables 1

- The payments must also be in compliance with 42 CFR 447.271 – charge limits.
- The table uses two years of inflation to trend 2009 cost report data to 2011. The inflation calculation would be adjusted based upon the year of the MCR used and the year of the payments being calculated.
- The cost report data used to calculate the Upper Payment Limit will be the latest available as filed or desk reviewed version.
- The table uses Medicaid payments and cases from the latest available Medicaid PS&R produced by the DMA Fiscal Agent for the cost report year.
- Cost of Teaching Physicians, Line 3c, shall include only the cost of the teaching component and exclude the professional component.

UPL calculation for Psychiatric and Rehabilitation Distinct Part Units

- The Upper Payment Limit for psychiatric and rehabilitation distinct part units will be calculated by taking each distinct part unit's Medicaid cost per discharge multiplied by the Medicaid distinct part unit discharges.

UPL calculation for Critical Access Hospitals (CAH)

- The Upper Payment Limit for CAH facilities will be 101% of the Medicare allowed cost per discharge multiplied by the Medicaid discharges for the cost report period.

State Plan Under Title XIX of the Social Security Act  
Medical Assistance Program  
State: NORTH CAROLINA

Payments for Medical and Remedial Care and Services: Inpatient Hospital

---

Attachment A

Certified Public Expenditures incurred in Providing services to Medicaid and Uninsured Patients

With respect to hospitals that the State of North Carolina determines eligible to certify public expenditures, and do certify, in accordance with 42 CFR 433.51(b), the expenditures claimable for Federal Financial Participation (FFP) will be the hospital's allowable costs incurred in serving Medicaid inpatients, as determined in accordance with Medicare cost principles. This computation of establishing interim Medicaid hospital payments must be performed on an annual basis.

Medicaid Hospital Costs:

(Effective January 1, 2011, this methodology will no longer apply for public hospitals with the approval of SPA 11.003.)

Inpatient Hospital Services—CPE Protocol

Rate Computation for Governmental Facilities – First and Final Reconciliation

For the payment year, the routine per diems and ancillary cost-to-charge ratios for the cost centers are determined using the hospital's most recently filed Medicare cost report (CMS 2552), as filed with the Medicare fiscal intermediary. The per diems and cost-to-charge ratios are calculated as follows:

Step 1:

Total hospital costs are identified from Worksheet B Part I Column 25. These are the costs that have already been reclassified, adjusted, and stepped down through the A and B worksheet series.

Step 2:

The hospital's total inpatient days by routine cost center are identified from Worksheet S-3 Part 1 Column 6. The hospital's total charges by ancillary cost center are identified from Worksheet C Part I Column 8.

Step 3:

For each inpatient routine cost center, a per diem is calculated by dividing total costs from Step 1 by total days from Step 2. For each ancillary cost center, a cost to charge ratio is calculated by dividing the total costs from Step 1 by the total charges from Step 2. The Adult and Pediatric (A&P) routine per diem, in accordance with CMS-2552 worksheet D-1, should be computed by including observation bed days in the total A&P patient day count and excluding swing bed nursing facility costs and non medically necessary private room differential costs from the A&P costs.

The inpatient per diems and cost to charge ratios determined through the above process (steps 1-3) for the filed cost report year are used to determine the hospital's costs for the payment year. The hospital costs for Medicaid for the payment year are determined as follows:

Step 4:

To determine the inpatient routine cost center costs for the payment year, the hospital's inpatient Medicaid days by cost center, as obtained from MMIS and other applicable sources for the period covered by the as-filed cost report will be used. The days are multiplied by the inpatient per diems from Step 3 for each routine respective cost center to determine the Medicaid allowable inpatient costs for each routine cost center. Only hospital routine cost centers and their associated costs and days are used. Other routine cost centers such as nursing facility, skilled nursing facility, and long term care services are excluded.

TN. No. 10-029  
Supersedes  
TN. No. NEW

Approval Date 03/26/2012

Eff. Date 10/01/2010

State Plan Under Title XIX of the Social Security Act  
Medical Assistance Program  
State: NORTH CAROLINA

Payments for Medical and Remedial Care and Services: Inpatient Hospital

---

Step 5:

To determine ancillary cost center costs for the payment year, the hospital's inpatient Medicaid allowable charges, as obtained from MMIS for the period covered by the as-filed cost report will be used. Medicaid allowable charges for observation beds must be included in line 62. These Medicaid allowable charges are multiplied by the cost to charge ratios from Step 3 for each respective ancillary cost center to determine the Medicaid allowable costs for each cost center. The Medicaid allowable charges used should only pertain to inpatient hospital services, and should exclude charges pertaining to outpatient hospital services, any professional services, or non-hospital component services such as hospital-based providers.

Step 6:

The Medicaid allowable share of organ acquisition costs is determined by first finding the ratio of Medicaid usable organs to total usable organs as identified from provider records by the hospital's total usable organs from Worksheet D-6 Part III under the Part B cost column line 54. This ratio is then multiplied by total organ acquisition costs from Worksheet D-6 Part III under the Part A cost column line 53. For this calculation, a usable organ is defined as the number of organs transplanted into a recipient, plus the number of organs excised and furnished to an organ procurement organization. "Medicaid usable organs" are counted as the number of Medicaid patients (recipients) who received an organ transplant. "Uninsured usable organs" are counted as the number of patients who received an organ transplant and had no insurance and no payment (self pay or free care). A donor's routine days and ancillary charges shall not be duplicative of any Medicaid or uninsured days and charges in Steps 4 and 5 above or from Steps 4 and 5 of the Uninsured portion of this protocol.

Step 7:

The Medicaid allowable costs eligible as certified public expenditures are determined by adding the Medicaid routine costs from Step 4, the Medicaid ancillary costs from Step 5 and the Medicaid organ acquisition costs from Step 6. Medicaid payments that are made independent of the Medicaid inpatient hospital per diem for Medicaid inpatient hospital services of which the costs are already included in the Medicaid inpatient hospital cost computation described above, must be offset against the computed Medicaid inpatient hospital cost before a per diem is calculated.

Step 8:

Net Cost is trended forward to payment year based on the Global Insight.

Step 9:

The projected annual cost will be claimed not more than four times during a federal fiscal year.

Step 10:

Medicaid provider assessments, as defined by 42 CFR 433.55, paid by the hospital shall be considered an allowable cost when determining the total allowable cost.

First Interim Payment Reconciliation:

The CMS 2552 costs determined through the method described for the payment year will be reconciled to the as-filed CMS 2552 cost report for the payment year once the cost report has been filed with the Medicare fiscal intermediary (FI). If, at the end of the interim reconciliation process, it is determined that a hospital received an overpayment, the overpayment will be properly credited to the federal government and if an underpayment is determined, the state will make the applicable claim from the federal government. For purposes of this reconciliation the same steps as outlined for the payment year method are carried out except for the changes noted below:

State Plan Under Title XIX of the Social Security Act  
Medical Assistance Program  
State: NORTH CAROLINA

Payments for Medical and Remedial Care and Services: Inpatient Hospital

---

Steps 1 – 3:

Days, costs, and charges from the as-filed CMS 2552 cost report for the payment year are used.

Steps 4, 5:

Actual Medicaid paid days and charges from the MMIS Provider Statistical an Reimbursement (PS&R) report for services furnished during the payment year are used.

Step 6:

Organ acquisition costs and total usable organs from the as-filed CMS 2552 cost report for the payment year are used.

Step 7:

Medicaid payments that are made independent of the Medicaid inpatient hospital per diem for Medicaid inpatient services of which the costs are already included in the Medicaid inpatient hospital cost computation described above, must be included in the total Medicaid payments (along with the interim Medicaid payments based on the Medicaid inpatient hospital per diem) under this interim reconciliation process. Adjustments made to the MMIS data mentioned above may address outstanding Medicaid claims for which the hospital has not received payment. The State will take steps to ensure that payments associated with the pending claims, when paid, for Medicaid costs included in the current spending year cost report are properly accounted.

Final Cost Report Reconciliation:

Once the CMS 2552 cost report for the payment year has been finalized by the Medicare FI with the issuance of a Notice of Program Reimbursement, a reconciliation of the finalized amounts will be carried out. Subsequent reconciliations and adjustments to the CPE claims are also performed for any cost report appeal resolution (including PRRB appeals and intermediary hearings) or cost report reopening that impacts the CPE computation as prescribed in this protocol. As well, any Supplement Enhancements related to payment year are offset. The same method as described for the interim reconciliation will be used except that the updated Medicaid program and payment data and finalized CMS 2552 amounts will be substituted as appropriate.

In the final reconciliation, Medicaid cost is computed using the methodology as prescribed by the CMS-2552 Worksheet D series. Worksheet D series include:

- 1) computing a per diem for each routine cost center and applying the applicable Medicaid inpatient days from MMIS data to the per diem amount;
- 2) using the appropriate Worksheet D-1 lines to compute the per diem for the routine cost centers, particularly the Adults & Pediatrics cost center; and
- 3) applying Worksheet C cost center-specific cost-to-charge ratios to the applicable Medicaid hospital charges for each ancillary cost center.

Use of Worksheet D series also includes the application of all Medicare cost report adjustments (including swing bed and private room differential adjustments) unless expressly exempt for Medicaid.

If, at the end of the final reconciliation process, it is determined that a hospital received an overpayment, the overpayment will be properly credited to the federal government and if is determined that a hospital received an underpayment, the underpayment will be properly claimed from the federal government.

The Medicaid allowable costs eligible as certified public expenditures are determined by adding the Medicaid routine costs from Step 4, the Medicaid ancillary costs from Step 5 and the Medicaid organ acquisition costs from Step 6. Medicaid payments that are made independent of the Medicaid inpatient hospital per diem for Medicaid inpatient hospital services of which the costs are already included in the Medicaid inpatient hospital cost computation described above must be offset against the computed Medicaid inpatient hospital cost.

State Plan Under Title XIX of the Social Security Act  
Medical Assistance Program  
State: NORTH CAROLINA

Payments for Medical and Remedial Care and Services: Inpatient Hospital

For hospitals whose cost report year is different from the State's fiscal year, the State will proportionally allocate to the State plan rate year the costs of two cost report periods encompassing the State Plan payment year. To do so, the State will obtain the actual Medicaid FFS days and charges for the hospital's cost reporting periods, and compute the aggregate Medicaid FFS cost for the reporting periods; this Medicaid FFS cost will then be proportionally allocated to the State plan rate year. All allocations will be made based upon number of months. (For example, for a hospital reporting period ending 12/31/07, the Medicaid FFS cost and days/charges from that period encompass three-fourths of the State plan rate year ending 9/30/2007, and one-fourth of the State plan rate year ending 9/30/2008. To fulfill reconciliation requirements for State plan rate year 2007, the hospital would match three-fourths of the Medicaid FFS costs from its reporting period ending 12/31/2007, and one-fourth of the Medicaid FFS costs from its reporting period ending 12/31/2006, to the State plan rate year.) The State will ensure that the total costs claimed in a State plan rate year will not exceed the costs justified in the underlying hospital cost reports for the applicable years.

Outpatient Hospital Services—CPE Protocol  
Rate Computation for Governmental Facilities – First and Final Reconciliation

For the payment year, ancillary cost-to-charge ratios for the cost centers are determined using the hospital's most recently filed Medicare cost report (CMS 2552), as filed with the Medicare fiscal intermediary. The cost-to-charge ratios are calculated as follows:

Step 1:

Total hospital costs are identified from Worksheet B Part I Column 25. These are the costs that have already been reclassified, adjusted, and stepped down through the A and B worksheet series.

Step 2:

The hospital's total charges by ancillary cost center are identified from Worksheet C Part I Column 8.

Step 3:

For each ancillary cost center, a cost to charge ratio is calculated by dividing the total costs from Step 1 by the total charges from Step 2.

The cost to charge ratios determined through the above process (steps 1-3) for the filed cost report year are used to determine the hospital's costs for the payment year. The hospital costs for Medicaid for the payment year are determined as follows:

Step 4:

To determine ancillary cost center costs for the payment year, the hospital's outpatient Medicaid FFS allowable charges, as obtained from MMIS for the period covered by the as-filed cost report will be used. These Medicaid allowable charges are multiplied by the cost to charge ratios from Step 3 for each respective ancillary cost center to determine the Medicaid allowable costs for each cost center. (Note that for the computation of the cost-to-charge ratio for cost center #62/Observation Beds, the cost amount is reported on worksheet C, Part I, column 1, instead of worksheet B.

State Plan Under Title XIX of the Social Security Act  
Medical Assistance Program  
State: NORTH CAROLINA

Payments for Medical and Remedial Care and Services: Inpatient Hospital

---

Medicaid allowable hospital outpatient charges for observation beds are then applied to this cost-to-charge ratio to compute the Medicaid outpatient observation bed costs.) The Medicaid allowable FFS charges used should only pertain to outpatient hospital services, and should exclude charges pertaining to inpatient hospital services, any professional services, or non-hospital component services.

Step 5:

The Medicaid allowable costs eligible as certified public expenditures are determined by adding the Medicaid ancillary costs from Step 4. All payments for Medicaid FFS outpatient services that are made independent of the process described in this cost computation section must be offset against the computed Medicaid FFS outpatient hospital cost.

Step 6:

Net Cost is trended forward to payment year based on the Global Insight factor.

Step 7:

The projected annual cost will be claimed not more than four times during a federal fiscal year.

Step 8:

Medicaid provider assessments, as defined by 42 CFR 433.55, paid by the hospital shall be considered an allowable cost when determining the total allowable cost.

First Interim Payment Reconciliation:

The CMS 2552 costs determined through the method described for the payment year will be reconciled to the as-filed CMS 2552 cost report for the payment year once the cost report has been filed with the Medicare fiscal intermediary (FI). If, at the end of the interim reconciliation process, it is determined that a hospital received an overpayment, the overpayment will be properly credited to the federal government and if an underpayment is determined, the state will make the applicable claim from the federal government. For purposes of this reconciliation the same steps as outlined for the payment year method are carried out except for the changes noted below:

Steps 1 – 3:

Costs and charges from the as-filed CMS 2552 cost report for the payment year are used.

Steps 4:

Actual Medicaid charges from the MMIS Provider Statistical and Reimbursement (PS&R) report for services furnished during the payment year are used.

State Plan Under Title XIX of the Social Security Act  
Medical Assistance Program  
State: NORTH CAROLINA

Payments for Medical and Remedial Care and Services: Inpatient Hospital

Step 5:

All payments for Medicaid FFS outpatient hospital services that are made independent of the process described in this cost computation section must be offset against the computed Medicaid FFS outpatient hospital cost (along with the interim Medicaid payments) under this interim reconciliation process. Adjustments made to the MMIS data mentioned above may address outstanding Medicaid claims for which the hospital has not received payment. The State will take steps to ensure that payments associated with the pending claims, when paid, for Medicaid costs included in the current spending year cost report are properly accounted.

Final Cost Report Reconciliation:

Once the CMS 2552 cost report for the payment year has been finalized by the Medicare FI with the issuance of a Notice of Program Reimbursement, a reconciliation of the finalized amounts will be carried out. Subsequent reconciliations and adjustments to the CPE claims are also performed for any cost report appeal resolution (including PRRB appeals and intermediary hearings) or cost report reopening that impacts the CPE computation as prescribed in this protocol. As well, any Supplement Enhancements related to payment year are offset. The same method as described for the interim reconciliation will be used except that the updated Medicaid program and payment data and finalized CMS 2552 amounts will be substituted as appropriate.

In the final reconciliation, Medicaid cost is computed using the methodology as prescribed by the CMS-2552 Worksheet D series. Worksheet D series include applying Worksheet C cost center-specific cost-to-charge ratios to the applicable Medicaid outpatient hospital charges for each ancillary cost center.

Use of Worksheet D series also includes the application of all Medicare cost report adjustments unless expressly exempt for Medicaid.

If, at the end of the final reconciliation process, it is determined that a hospital received an overpayment, the overpayment will be properly credited to the federal government and if it is determined that a hospital received an underpayment, the underpayment will be properly claimed from the federal government.

The Medicaid allowable costs eligible as certified public expenditures are determined by adding the Medicaid ancillary costs from Step 4. All payments for Medicaid FFS outpatient hospital services that are made independent of the process described in this cost computation section must be offset against the computed Medicaid FFS outpatient hospital cost.

For hospitals whose cost report year is different from the State's fiscal year, the State will proportionally allocate to the State plan rate year the costs of two cost report periods encompassing the State Plan payment year. To do so, the State will obtain the actual Medicaid FFS outpatient hospital charges for the hospital's cost reporting periods, and compute the aggregate Medicaid FFS outpatient hospital cost for the reporting periods; this Medicaid FFS outpatient hospital cost will then be proportionally allocated to the State plan rate year. All allocations will be made based upon number of months. (For example, for a hospital reporting period ending 12/31/07, the Medicaid FFS outpatient hospital cost and charges from that period encompass three-fourths of the State plan rate year ending 9/30/2007, and one-fourth of the State plan rate year ending 9/30/2008. To fulfill reconciliation requirements for State plan rate year 2007, the hospital would match three-fourths of the Medicaid FFS costs from its reporting period ending 12/31/2007, and one-fourth of the Medicaid FFS costs from its reporting period ending 12/31/2006, to the State plan rate year. The State will ensure that the total costs claimed in a State plan rate year will not exceed the costs justified in the underlying hospital cost reports for the applicable years.

TN. No. 10-029  
Supersedes  
TN. No. NEW

Approval Date 03/26/2012

Eff. Date 10/01/2010

State Plan Under Title XIX of the Social Security Act  
Medical Assistance Program  
State: NORTH CAROLINA

Payments for Medical and Remedial Care and Services: Inpatient Hospital

---

CPEs Incurred in Providing Services to Uninsured patients (Uncompensated Care):

The North Carolina Division of Medical Assistance collects information on hospitals' charges for services they provide to uninsured patients and any payments hospitals receive by or on behalf of those patients. The Division collects this information on a supplemental Schedule A for uncompensated care that the hospitals' CEO, CFO or their designee must sign and certify to the accuracy of the reported information.

The Division will determine the inpatient uncompensated care costs on an interim basis by multiplying the inpatient charges by a charge-to-cost conversion factor as calculated using Medicare cost principles and detailed in the protocol above for Medicaid inpatient cost.

The Division will determine the outpatient uncompensated care cost on an interim basis by multiplying the outpatient uncompensated charges by the outpatient cost-to-charge ratio as calculated in the above protocol for Medicaid outpatient cost.

Final Cost Report Reconciliation

The Division will use the protocol as outlined above for the final cost report reconciliation between the estimated CPEs and the actual CPEs incurred by the hospital for uncompensated care.



State Plan Under Title XIX of the Social Security Act  
Medical Assistance Program  
State: NORTH CAROLINA

Payments for Medical and Remedial Care and Services: Inpatient Hospital

---

---

**DIVISION OF VOCATIONAL REHABILITATION SERVICES DSH PAYMENTS**

(i) Effective with dates of payment beginning October 31, 1996, each hospital that provides services to clients of State Agencies are considered to be a Disproportionate Share Hospital (DSH) when the following conditions are met:

- (1) The hospital qualifies for disproportionate share hospital status under Paragraph (c) of this Section;
- (2) The State Agency has entered into a Memorandum of Understanding (MOU) with the Division of Medical Assistance (Division) for services provided after October 31, 1996; and
- (3) The inpatient and/or outpatient services are authorized by the State Agency for which the uninsured patient meets the program requirements

For purposes of this Paragraph uninsured patients are those clients of the State Agency who have no third parties responsible for any hospital services authorized by the State Agency.

- (4) DSH payments are paid for services to qualified uninsured patients on the following basis:
  - (A) For inpatient services the amount of the DSH payment is determined by the State Agency in accordance with the applicable Medicaid inpatient payment methodology as stated in Section 4.19-A of the State Plan.
  - (B) For outpatient services the amount of the DSH payment is determined by the State Agency in accordance with the applicable Medicaid outpatient payment methodology as stated in Section 4.19-B of this State Plan.
  - (C) No federal funds are utilized as the non-federal share of authorized payments unless the federal funding is specifically authorized by the federal funding agency as eligible for use as the non-federal share of payments.
- (5) Based upon this Subsection DSH payments as submitted by the State Agency are to be paid monthly in an amount to be reviewed and approved by the Division of Medical Assistance. The total of all payments may not exceed applicable limits on Disproportionate Share Hospital funding.

State Plan Under Title XIX of the Social Security Act  
Medical Assistance Program  
State: NORTH CAROLINA

Payments for Medical and Remedial Care and Services: Inpatient Hospital

**MEDICAID HMO DSH PAYMENTS**

(j) Additional disproportionate share hospital payments for the 12-month periods ending September 30 of each year shall be paid to hospitals licensed by the State of North Carolina that qualify for disproportionate share hospital status under Paragraph (c) of the “Disproportionate Share Hospital Payment” section of this Plan and provide inpatient or outpatient hospital services to Medicaid Health Maintenance Organizations (“HMO”) enrollees during the period for which payments under this Paragraph are being ascertained. For purposes of this Paragraph, a Medicaid HMO enrollee is a Medicaid beneficiary who receives Medicaid services through a Medicaid HMO; a Medicaid HMO is a Medicaid managed care organization, as defined in Section 1903(m)(1)(A), that is licensed as an HMO or operates under 42 CFR 438 as a Prepaid Inpatient Health Plan (PIHP), and provides or arranges for services for enrollees under a contract pursuant to Section 1903 (m)(2)(A)(i) through (xi). To qualify for a DSH payment under this Paragraph, a hospital must also file with and certify to the Division for the most recent fiscal year available at the time of data collection, its charges for inpatient and outpatient services provided to Medicaid HMO enrollees on a form prescribed by the Division.

- (1) The payments to qualified hospitals pursuant to this Paragraph shall be based on costs for inpatient and outpatient services provided to Medicaid HMO enrollees for the most recent available hospital fiscal year. Medicaid inpatient HMO costs will be calculated by multiplying the Medicaid charge-to-cost conversion factor calculated using the CMS 2552 cost report for the same fiscal year as used in determining hospitals’ Base Enhanced Payments for Inpatient Hospital Service in (e.1)(2)(A) of this plan, by inpatient charges for Medicaid HMO patients for the same fiscal year. Medicaid outpatient HMO cost will be determined by multiplying the Medicaid cost-to-charge ratio calculated using the CMS 2552 cost report for the same fiscal year as used in determining the hospitals’ Base Enhanced Payments for Outpatient Hospital Service in 4.19-B, 2.a.1(2)A. Each hospital’s payment shall then be determined as follows:
  - (A) The ratio of the sum of Base Enhanced Payment for Inpatient Hospital Services as calculated in accordance with (e.1) 1 and (e.1) 2 of this plan and Base Enhanced Payment for Outpatient Hospital Services as calculated in accordance with 2.a.1 of this plan to the sum of inpatient Medicaid costs as determined in (e.1) (2)(A) i through iii of the Base Enhanced Payment for Inpatient Hospital Services section of this plan and outpatient Medicaid costs as determined in 2.a.1(2).A. through B. of the Base Enhanced Payment for Outpatient Hospital Services section of this plan.
  - (B) Multiply the above ratio by the calculated Medicaid HMO costs as described in subparagraph (j) (1) of this Section.
- (2) Payments authorized by this Paragraph shall be made paid annually, in up to four installments.

State Plan Under Title XIX of the Social Security Act  
Medical Assistance Program  
State: NORTH CAROLINA

Payments for Medical and Remedial Care and Services: Inpatient Hospital

---

---

#### **UNIVERSITY OF NORTH CAROLINA DSH PAYMENT**

(k) Hospitals owned or controlled by the University of North Carolina Health Care System, as defined in N.C. Gen. Stat. § 116-37, and that qualify under Paragraph (c) of this Section shall be eligible to receive disproportionate share hospital payments that, when combined with other disproportionate share hospital payments described in this Section, will equal 100 percent of their unreimbursed uninsured except as otherwise provided for in (2) and (3) below, and as limited by Paragraph (a). These DSH payments shall be calculated after accounting for all other Medicaid payments, including payments under Paragraph (h) of the EXCEPTIONS TO DRG REIMBURSEMENT, and after accounting for all other DSH payments to hospitals in North Carolina, including the hospitals eligible for payments under this Paragraph. The aggregate payment to eligible hospitals under this Paragraph shall not exceed the total cost incurred by the University of North Carolina Hospitals at Chapel Hill dba UNC Hospitals for providing care to patients who have no insurance for the services provided.

- (1) Unreimbursed uninsured costs shall be calculated based on the hospitals' gross charges and payments for uninsured inpatient and outpatient hospital services as filed with and certified to the Division for the most recent fiscal year available at the time of data collection. The Division will convert hospitals' gross charges to costs by multiplying them by a cost-to-charge ratio determined from the hospitals' most recent cost reports available at the time of data collection and subtracting payments the hospitals received from uninsured patients. The Division will bring the unreimbursed uninsured cost data forward to the end of the payment period by applying an inflation factor calculated based on the most current information available at the time on the CMS website for the CMS PPS Hospital Input Price Index.
- (2) Effective January 1, 2004, for State fiscal years 2004 and 2005, these hospitals shall receive disproportionate share hospital payments that, when combined with other disproportionate share payments described in this Section, shall equal 150 percent of their unreimbursed uninsured costs.
- (3) To the extent the limits on disproportionate share hospital funding for this State established by CMS in accordance with 42 U.S.C. § 1396r-4(f) do not allow payments to all eligible hospitals up to 100 percent of each hospital's unreimbursed costs, this percentage shall be reduced to comply with such limits.

State Plan Under Title XIX of the Social Security Act  
Medical Assistance Program  
State: North Carolina

Payments for Medical and Remedial Care And Services: Inpatient Hospital

**OUT-OF-STATE-HOSPITALS**

- (a) Except as noted in Paragraph (c) below, the Division of Medical Assistance shall reimburse out-of-state hospitals using the DRG methodology. Effective January 1, 2015, the DRG hospital unit value for all out-of state hospitals shall be equal to the unit value of the North Carolina hospitals' statewide median rate as of June 30, 2014. Out-of-state providers are eligible to receive cost and day outlier payments, but not direct medical education payment adjustments.
- (b) Hospitals that are certified for indirect medical education by Medicare may apply for an indirect medical education adjustment to its North Carolina rate.
- (c) Hospitals certified as disproportionate share hospitals by the Medicaid agency in their home state may apply for a disproportionate share adjustment to their North Carolina Medicaid rate. The North Carolina disproportionate share hospital rate adjustment shall be the hospital's home state DSH adjustment, not to exceed 2.5 percent of the DRG or per diem payment. The Division will apply the disproportionate share hospital rate adjustment to Medicaid inpatient claims submitted by qualified out-of-state hospitals.
- (d) The Division of Medical Assistance may enter into contractual relationships with certain hospitals providing highly specialized inpatient services, i.e. transplants in which case reimbursement for inpatient services shall be based upon a negotiated rate.

State Plan Under Title XIX of the Social Security Act  
Medical Assistance Program  
State: North Carolina

Payments for Medical and Remedial Care and Services: Inpatient Hospital

---

**SPECIAL SITUATIONS**

(a) In order to be eligible for inpatient hospital reimbursement under this hospital inpatient reimbursement plan, a patient must be admitted as an inpatient and stay past midnight in an inpatient bed. The only exceptions to this requirement are those admitted inpatients who die or are transferred to another acute care hospital on the day of admission. Hospital admissions prior to 72 hours after a previous inpatient hospital discharge are subject to review by the Division of Medical Assistance.

Services for patients admitted and discharged on the same day and who are discharged to home or to a non-acute care facility must be billed as outpatient services. In addition patients who are admitted to observations status do not qualify as inpatients, even when they stay past midnight. Patients in observation status for more than 30 hours must either be discharged or converted to inpatient status.

(b) Outpatient services provided by a hospital to patients within the 24 hour period prior to an inpatient admission in the same hospital that are related to the inpatient admission shall be bundled with the inpatient billing.

(c) When a patient is transferred between hospitals, the transferring hospital shall receive a pro-rated payment equal to the normal DRG payment multiplied by the patient's actual length of stay divided by the geometric mean length of stay for the DRG. When the patient's actual length of stay equals or exceeds the geometric mean length of stay for the DRG, the transferring hospital receives full DRG payment. Transfers are eligible for cost outlier payments. The final discharging hospital shall receive the full DRG payment.

(d) For discharges occurring on October 1, 2001 through September 30, 2008, a discharge of a hospital inpatient is considered to be a transfer under paragraph (c) above when the patient's discharge is assigned to one of the following qualifying diagnosis-related groups, DRGs 14, 113, 209, 210, 211, 236, 263, 264, 429, and 483 and the discharge is made under any of the following circumstances in (d)(1), (d)(2) or (d)(3) listed below. For discharges occurring on or after October 1, 2008, a discharge of a hospital inpatient is considered to be a transfer under paragraph (c) above when the patient's discharge is assigned to one of the following qualifying diagnosis-related groups, DRGs 28, 29, 30, 40, 41, 42, 219, 220, 221, 477, 478, 479, 480, 481, 482, 492, 493, 494, 500, 501, 502, 515, 516, 517, and 956 and the discharge is made under any of the following circumstances in (d)(1), (d)(2) or (d)(3) listed below:

- (1) To a hospital or distinct part hospital unit excluded from the DRG reimbursement system;
- (2) To a skilled nursing facility; or
- (3) To home under a written plan of care for the provision of home health services from a home health agency and those services begin within 3 days after the date of discharge.

---

TN. No: 08-012  
Supersedes  
TN. No: 05-015

Approval Date: 04/09/09

Eff. Date 10/01/2008

State Plan Under Title XIX of the Social Security Act  
Medical Assistance Program  
State: North Carolina

Payments for Medical and Remedial Care And Services: Inpatient Hospital

---

(e) Days for authorized nursing facility level of care rendered in an acute care hospital shall be reimbursed at a rate equal to the average rate for all such Medicaid days based on the rates in effect for the long term care plan year beginning each October 1. Notwithstanding any other provision, if specified, these rates will be adjusted as shown on Attachment 4.19-A, Supplement 1, Page 1 of the Sate Plan.

Days for lower than acute level of care for ventilator dependent patients in swing-bed hospitals or that have been down-graded through the utilization review process may be paid for up to 180 days at a lower level ventilator-dependent rate if the hospital is unable to place the patient in a lower level facility. An extension may be granted if in the opinion of the Division of Medical Assistance the condition of the patient prevents acceptance of the patient. A single all inclusive prospective per diem rate is paid, equal to the average rate paid to nursing facilities for ventilator-dependent services. The hospital must actively seek placement of the patient in an appropriate facility.

(f) The Division of Medical Assistance may make a retrospective review of any transfers to a lower level of care prior to the expiration of the average length of stay for the applicable DRG. The Division of Medical Assistance may adjust the DRG payment if the transfer is deemed to be inappropriate, based on the preponderance of evidence of a case by case review.

(g) In state-operated hospitals, the appropriate lower level of care rates equal to the average rate paid to state operated nursing facilities, are paid for nursing facility level of care patients awaiting placement in a nursing facility bed.

(h) For an inpatient hospital stay where the patient is Medicaid eligible for only part of the stay, the Medicaid program shall pay the DRG payment less the patient's liability or deductible, if any, as provided by 10 NCAC 50B .0406 and .0407. (see page 28-28(c) of this plan)

State Plan Under Title XIX of the Social Security Act  
Medical Assistance Program  
State: North Carolina

Payments for Medical and Remedial Care And Services: Inpatient Hospital

**COST REPORTING AND AUDITS**

(a) Annual cost reports shall be filed as directed by the Division of Medical Assistance in accordance with 42 CFR 447.253 (f) and (g).

(b) The Medicaid Cost Report is due five (5) months after the provider's fiscal year end or 37 days from the date of the PS&R letter, which ever is later. Hospitals that fail to fully and accurately complete Medicaid cost reports within the time period specified by the Division of Medical Assistance or that fail to furnish required documentation and disclosures for Medicaid cost reports required under this Plan within the time period specified by the Division, may be subject to penalties for non-compliance. A penalty of 20% withhold of Medicaid payments will be imposed upon the delinquent hospital 30 days after the Medicaid cost report filing deadline unless the hospital has made a written request for an extension of the Medicaid cost report filing due date to the Division of Medical Assistance and has received a written approval from the Division of Medical Assistance. The withholding of monies will continue until the Medicaid cost report filing requirements have been satisfied. Any monies withheld as penalty will not accrue interest to the benefit of the hospital.

State Plan Under Title XIX of the Social Security Act  
Medical Assistance Program  
State: North Carolina

Payments for Medical and Remedial Care And Services: Inpatient Hospital

#### **ADMINISTRATIVE RECONSIDERATION REVIEWS**

Reconsideration reviews of rate determinations shall be processed in accordance with the provisions of 10 NCAC 26K (See page 29 – 29(a) of this plan). Requests for reconsideration reviews shall be submitted to the Division of Medical Assistance within 60 days after rate notification, unless unexpected conditions causing intense financial hardship arise, in which case a reconsideration review may be considered at any time.

---

TN. No. 05-015  
Supersedes  
TN. No. 94-33

Approval Date December 15, 2005

Eff. Date 10/01/2005



State Plan Under Title XIX of the Social Security Act  
Medical Assistance Program  
State: North Carolina

Payments for Medical and Remedial Care And Services: Inpatient Hospital

**BILLING STANDARDS**

(a) Providers shall use codes from the International Classification of Diseases, 9th Revision, Clinical Modification (ICD-9-CM) to report diagnoses and procedures. This material is hereby incorporated by reference including any subsequent amendments and editions and is available for inspection at the Division of Medical Assistance, 1985 Umstead Drive, Raleigh, NC. Copies may be obtained from the American Medical Association, 515 North State Street, Chicago, IL 60610 at a cost of fifty nine dollars and ninety five cents (\$59.95). Tel: 800-621-8335. Providers shall use the codes which are in effect at the time of discharge. The reporting of ICD-9-CM diagnosis and procedure codes shall follow national coding guidelines promulgated by the Centers for Medicare and Medicaid Services.

(b) Providers shall generally bill only after discharge. However, interim billings may be submitted on or after 60 days after an admission and on or after every 60 days thereafter.

(c) The discharge claim is required for Medicaid payment. The purpose of this Rule is to assure a discharge status claim is filed for each Medicaid stay.

- (1) An interim billing must be followed by a successive interim billing or discharge (final) billing within 180 days of the date of services on the most recent claim. When an interim claim is not followed by an additional interim or discharge (final) claim within 180 days of the "to date of services" on the most recent paid claim, all payments made for all claims for the stay will be recouped.
- (2) After a recoupment is made according to this plan, a subsequent "admit through discharge" or interim claim for payment will be considered for normal processing and payment unless the timely filing requirements of 10 NCAC 26D .0012 are exceeded (See page 30 of this plan).

State Plan Under Title XIX of the Social Security Act  
Medical Assistance Program  
State: North Carolina

Payments for Medical and Remedial Care And Services: Inpatient Hospital

---

**PAYMENT OF MEDICARE PART A DEDUCTIBLES**

For payment of Medicare Part A claims, the Division of Medical Assistance shall pay the Medicaid DRG payment less the amount paid by Medicare not to exceed the sum of the Medicare Coinsurance and Deductible. For payment of Medicare Part A claims for psychiatric and rehabilitation services, the Division of Medical Assistance shall pay the Medicaid per diem less the amount paid by Medicare not to exceed the sum of Medicare Coinsurance and Deductible.

**PAYMENT ASSURANCES**

The state shall pay each hospital the amount determined for inpatient services provided by the hospital according to the standards and methods set forth in this plan. In all circumstances involving third party payment, Medicaid shall be the payor of last resort.

**PROVIDER PARTICIPATION**

Payments made according to the standards and methods described in this plan are designed to enlist the participation of a majority of hospitals in the program so that eligible persons can receive medical care services covered by the North Carolina Medicaid program at least to the extent these services are available to the general public.

**PAYMENT IN FULL**

Participation in the North Carolina Medicaid program shall be limited to hospitals who accept the amount paid in accordance with this plan as payment in full for services rendered to Medicaid recipients.

State Plan Under Title XIX of the Social Security Act  
Medical Assistance Program  
State: North Carolina

Payments for Medical and Remedial Care And Services: Inpatient Hospital

---

These changes to the payment for general hospital inpatient services reimbursement plan will become effective when:

The Centers for Medicare and Medicaid Services, U.S. Department of Health and Human Services, approves amendment submitted to CMS by the Director of the Division of Medical Assistance on or about January 1, 1995 as #MA 94-33, wherein the Director proposes amendments of the State Plan to amend payment for general hospital inpatient services.

---

TN. No. 05-015  
Supersedes  
TN. No. 94-33

Approval Date December 15, 2005

Eff. Date 10/01/2005

State Plan Under Title XIX of the Social Security Act  
Medical Assistance Program  
State: NORTH CAROLINA

Payments for Medical and Remedial Care And Services: Inpatient Hospital

During the process of estimating costs on a claim by claim basis, all costs were inflated to State Fiscal Year 1994 using the North Carolina hospital market basket rates of 5.1% for SFY 1993 and 4.7% for SFY 1994. For routine services, this was done by inflating the per diem rate from the cost report fiscal year to SFY 1994. For example:

Assume a routine per diem of \$600 with a hospital cost report fiscal year end of 12/31/93 and an inflation rate of 4.4% per annum.

June 31, 1994 – December 31, 1993 – 181 days

$$\$600 * (1 + (181/365 * 0.047)) = \$613.98$$

For ancillary services, the starting point for any inflation adjustment is the date of service on the claim. This practice assumes that hospitals regularly increase their ancillary charges in response to increased costs, such that the use of the cost to charge ratio from last year's cost report applied to this year's charge should result in a close approximation of costs.

The costs for all ancillary service line items on all claims were adjusted to the midpoint of SFY 1994 (January 1, 1994) using the NC Hospital market basket rates<sup>2</sup>. For example:

- (1) Assume that the discharge date on a claim is 12/15/93, with charges of \$600:

January 1, 1994 - July 15, 1993 = 199 days

$$\$600 * (1 + (199/365) * .047) = \$615.37$$

- (2) Assume that the discharge date on a claim is 3/15/94 with charges of \$600:

January 1, 1994 – March 15, 1994 = 73 days

$$\$600 * (1 + (-73/365) * .047) = \$594.36$$

<sup>2</sup>Cost estimates for claims with dates of services after the fiscal year midpoint were deflated back to January 1, 1994. However, to avoid biases due to completion rates, we ultimately decided not to use these claims in rate setting.

State Plan Under Title XIX of the Social Security Act  
Medical Assistance Program  
State: NORTH CAROLINA

Payments for Medical and Remedial Care and Services: Inpatient Hospital

Exhibit 5.1

North Carolina DRG Project Data Model      Option 1: Statewide DRG Rates      *Hospitals below 45th Percentile Receive 75/25 Blend of their Rate and 45th %ile Rate*  
Transfers: Prorated      Combined Operating & Capital Rate      *Hospitals above 45th Percentile Receive 45th %ile Rate with Medical Education Adjustments*  
Stat. Outliers: Included  
Transplant DRGs: Included  
ych/Rehab: Excluded

Provider Number	Provider Name	IME Factor	DME Factor	No. of Disch	No. of Days	Medicaid Cost	Cost Less Med Ed	Proj. Decline in Days	Routine Daily Cost	DRG Cost Less Med Ed	Vers. 12 CMI	Cost per CMI-Adj Disch.	Less Out @ 7.2%	Base Rate	Rate with Med Ed
i	b	d	e	f	g	h	inh(1-e)(1+d)	j/g*.08	k	luj'K	m	n-e\$1m	o=n*0.928	p	q=p'(1+d*e)
1%	3400045	Blowing Rock Hospital		7	16	7,759	7,759	1.3	\$220.23	7,473	0.9546	1,118	\$1,038	1,394	1,394
2%	3400101	Bertie Memorial Hospital		39	144	78,831	78,831	11.5	\$280.20	75,609	1.2387	1,565	\$1,452	1,705	1,705
3%	3400054	District Memorial Hospital		69	242	123,998	123,998	19.4	\$232.03	119,497	1.0475	1,653	\$1,534	1,766	1,766
3%	3400036	Franklin Regional Medical Ctr		113	410	236,664	236,664	32.8	\$294.09	227,018	1.1421	1,759	\$1,632	1,840	1,840
4%	3400036	Beaufort County Hospital		197	752	432,342	432,342	60.2	\$379.24	409,511	1.1332	1,834	\$1,702	1,892	1,892
5%	3400044	Alleghany County Hospital		71	181	108,340	108,340	14.5	\$393.80	102,630	0.7543	1,916	\$1,778	1,949	1,949
6%	3400022	Bladen County Hospital		385	1,093	593,042	593,042	87.4	\$321.28	564,962	0.7373	1,990	\$1,847	2,001	2,001
7%	3400063	Montgomery Memorial Hospital		260	728	375,589	375,589	58.2	\$353.06	355,041	0.6786	2,012	\$1,867	2,016	2,016
8%	3400097	Hugh Chatham Memorial		143	443	246,358	246,358	35.4	\$278.73	236,491	0.8133	2,033	\$1,887	2,031	2,031
8%	3400089	Pungo District Hospital		99	325	204,911	204,911	26.0	\$397.85	194,566	0.9624	2,042	\$1,895	2,037	2,037
9%	3400124	Good Hope Hospital		75	411	194,098	194,098	32.9	\$308.88	183,936	1.1032	2,055	\$1,907	2,048	2,048
0%	3400120	Duplin General Hospital		472	1,321	676,473	676,473	105.7	\$317.95	642,866	0.6538	2,083	\$1,933	2,065	2,065
1%	3400072	Ashe Memorial Hospital		161	441	271,123	271,123	35.3	\$287.29	262,040	0.8253	2,103	\$1,951	2,079	2,079
2%	3400013	Rutherford County Hospital		658	1,729	959,388	959,388	138.3	\$310.08	916,504	0.6545	2,128	\$1,975	2,097	2,097
3%	3400035	Richmond Memorial Hospital		588	1,703	905,815	905,815	136.2	\$298.33	865,183	0.6877	2,139	\$1,985	2,104	2,104
4%	3400017	Pardee Memorial Hospital		377	1,465	788,842	788,842	117.2	\$316.66	751,729	0.9319	2,140	\$1,986	2,104	2,104
4%	3400148	Medical Park Hospital		20	90	79,974	79,974	7.2	\$321.03	77,662	1.8003	2,157	\$2,002	2,116	2,116
5%	3400132	Maria Parham Hospital		610	1,818	1,089,200	1,089,200	145.4	\$311.03	1,043,977	0.7904	2,165	\$2,009	2,122	2,122
6%	3400106	Hamlet Hospital		149	558	316,838	316,838	44.6	\$284.02	304,171	0.9394	2,173	\$2,017	2,128	2,128
7%	3400052	Davie County Hospital		37	150	85,897	85,897	12.0	\$298.13	82,320	1.0237	2,173	\$2,017	2,128	2,128
8%	3400015	Rowan Memorial Hospital		1,032	3,140	1,609,749	1,609,749	251.2	\$384.51	1,513,160	0.6685	2,193	\$2,036	2,142	2,142
9%	3400093	Pender Memorial Hospital		75	312	175,080	175,080	25.0	\$252.85	168,759	1.0205	2,205	\$2,046	2,150	2,150
9%	3400090	Johnston Memorial Hospital		662	2,183	1,107,285	1,107,285	174.6	\$288.58	1,056,899	0.7185	2,222	\$2,062	2,162	2,162
10%	3400085	Community General Hospital		593	1,914	964,121	964,121	153.1	\$264.86	923,571	0.7000	2,225	\$2,065	2,164	2,164
11%	3400122	Our Community Hospital		1	4	3,311	3,311	0.3	\$566.88	3,141	1.3904	2,259	\$2,096	2,187	2,187
12%	3400065	Chowan Hospital		476	1,442	735,490	735,490	115.4	\$329.56	697,459	0.6495	2,256	\$2,094	2,185	2,185
13%	3400003	Northern Hospital of Surry		434	1,244	755,036	755,036	99.5	\$308.49	724,342	0.7351	2,270	\$2,107	2,196	2,196
14%	3400080	Sloop Memorial Hospital		131	363	216,893	216,893	29.0	\$363.29	206,358	0.6918	2,277	\$2,113	2,200	2,200
15%	3400098	Columbus County Hospital		929	2,820	1,722,173	1,722,173	225.6	\$258.83	1,663,781	0.7833	2,286	\$2,122	2,207	2,207
15%	3400159	Person County Hospital		50	218	142,861	142,861	17.4	\$298.89	137,460	1.1969	2,297	\$2,132	2,214	2,214
16%	3400007	Annie Penn Memorial Hosp		436	1,714	833,003	833,003	137.1	\$251.09	798,579	0.7913	2,315	\$2,148	2,226	2,226
17%	3400075	Grace Hospital		742	2,387	1,239,311	1,239,311	191.0	\$364.18	1,169,752	0.6779	2,326	\$2,158	2,234	2,234
18%	3400099	Roanoke Chowan Hospital		947	3,824	1,711,259	1,711,259	305.9	\$224.25	1,642,661	0.7410	2,341	\$2,172	2,245	2,245
19%	3400020	Central Carolina Hospital		688	1,933	1,188,370	1,188,370	154.6	\$288.38	1,143,787	0.7051	2,358	\$2,188	2,256	2,256
10%	3400119	Stanly Memorial Hospital		429	1,348	859,084	859,084	107.8	\$337.52	822,700	0.8072	2,376	\$2,205	2,269	2,269
11%	3400037	Kings Mountain Hospital		60	325	149,235	149,235	26.0	\$320.18	140,911	0.9814	2,393	\$2,221	2,281	2,281
11%	3400019	Stokes Reynolds Memorial Hospi		50	256	150,340	150,340	20.5	\$285.88	144,480	1.2066	2,395	\$2,222	2,282	2,282
12%	3400098	Lexington Memorial		558	1,243	931,899	931,899	99.4	\$431.60	888,998	0.6637	2,400	\$2,227	2,286	2,286
13%	3400016	C. J. Harris Community Hospital		791	2,220	1,372,653	1,372,653	177.6	\$317.71	1,316,228	0.6895	2,413	\$2,239	2,295	2,295
14%	3400084	Anson County Hospital		101	390	256,393	256,393	31.2	\$392.21	244,156	0.9876	2,448	\$2,271	2,319	2,319
15%	3400011	Blue Ridge Hospital System		205	556	420,850	420,850	44.5	\$329.47	406,189	0.8024	2,469	\$2,292	2,334	2,334
16%	3400145	Lincoln County Hospital		679	2,049	1,221,480	1,221,480	163.9	\$361.61	1,162,212	0.6878	2,489	\$2,310	2,347	2,347
16%	3400121	Dosher Memorial Hospital		44	186	119,701	119,701	14.9	\$385.42	113,958	1.0390	2,493	\$2,313	2,350	2,350

Myers and Stauffer, 06/12/2000

1\_model.xls SW2

Page 1

TN No. 05-015  
Supersedes  
TN No. 00-23

Approval Date December 15, 2005

Eff. Date 10/01/2005

State Plan under Title XIX of the Social Security Act  
Medical Assistance Program  
State: NORTH CAROLINA

Payments for Medical and Remedial Care and Services: Inpatient Hospital

Exhibit 5.1

Provider Number		IME Factor	DME Factor	No. of Disch	No. of Days	Medicaid Cost	Cost Less Med Ed	Proj Decline in Days	Routine Daily Cost	DRG Cost Less Med Ed	Vers. 12 CMI	Cost per CMI-Adj Disch	Less Out @ 7.2%	Base Rate	Rate with Med Ed
a	b	c	d	e	f	g	h=(g)-(e)+f	i=8g-20f	j	k	l	m	n=(10.98g)-p	o	q=(l)-(n)
37%	3400071			602	1,988	1,168,977	1,168,977	159.0	\$296.72	1,121,481	0.7436	2,505	\$2,325	2,359	2,359
38%	3400024			622	2,155	1,269,002	1,269,002	172.4	\$364.93	1,206,088	0.7644	2,537	\$2,354	2,381	2,381
39%	3400127			286	878	616,778	616,778	70.2	\$324.06	594,029	0.8103	2,563	\$2,379	2,399	2,399
40%	3400042			1,046	3,496	2,198,916	2,198,916	279.7	\$364.67	2,096,918	0.7789	2,574	\$2,388	2,407	2,407
41%	3400018			15	43	37,718	37,718	3.4	\$373.05	36,450	0.9418	2,580	\$2,394	2,411	2,411
42%	3400129			135	524	335,844	335,844	41.9	\$297.30	323,387	0.9167	2,613	\$2,425	2,434	2,434
42%	3400031			36	157	119,939	119,939	12.6	\$402.13	114,872	1.2090	2,639	\$2,449	2,452	2,452
43%	3400021			1,011	3,448	2,121,168	2,121,168	275.8	\$415.62	2,006,940	0.7514	2,641	\$2,451	2,454	2,454
44%	3400111			21	76	60,651	60,651	6.1	\$403.47	58,190	1.0455	2,648	\$2,457	2,458	2,458
45%	3400028	0.0281	0.0056	3,548	14,591	8,586,654	8,586,334	1167.3	\$251.23	8,273,073	0.8792	2,652	\$2,461	2,461	2,544
46%	3400115			1,278	5,192	3,720,968	3,720,968	415.4	\$325.67	3,585,684	1.0422	2,692	\$2,498	2,461	2,461
47%	3400025			477	1,585	1,026,348	1,026,348	126.8	\$343.79	982,756	0.7544	2,731	\$2,534	2,461	2,461
47%	3400160			191	556	419,532	419,532	44.5	\$315.62	405,487	0.7680	2,764	\$2,565	2,461	2,461
48%	3400060			516	1,722	1,118,894	1,118,894	137.8	\$256.39	1,083,563	0.7535	2,787	\$2,586	2,461	2,461
49%	3400112			73	307	182,679	182,679	24.6	\$294.37	175,438	0.8560	2,807	\$2,605	2,461	2,461
50%	3400051			999	1,117	849,393	849,393	89.4	\$360.01	817,208	0.7432	2,827	\$2,623	2,461	2,461
51%	3400069	0.0420	0.0180	3,488	14,635	10,203,114	9,625,032	1170.8	\$379.38	9,180,854	0.9305	2,829	\$2,625	2,461	2,608
52%	3400126			1,200	3,997	2,694,684	2,694,684	319.8	\$327.22	2,590,039	0.7617	2,834	\$2,630	2,461	2,461
53%	3400040	0.2095	0.0867	3,567	17,926	16,747,298	12,741,021	1434.1	\$514.30	12,003,463	1.1857	2,838	\$2,634	3,700	3,700
53%	3400034			668	2,265	1,606,161	1,606,161	181.2	\$367.38	1,537,968	0.7560	3,045	\$2,826	2,461	2,461
54%	3400006			41	127	114,222	114,222	10.2	\$506.87	109,052	0.9311	2,859	\$2,651	2,461	2,461
55%	3400010			1,202	4,880	2,977,427	2,977,427	390.4	\$308.52	2,856,960	0.8319	2,857	\$2,651	2,461	2,461
56%	3400156			154	573	515,464	515,464	45.8	\$548.76	490,361	1.1137	2,859	\$2,653	2,461	2,461
57%	3400131			1,249	4,970	3,101,950	3,101,950	397.6	\$322.01	2,973,919	0.8316	2,863	\$2,657	2,461	2,461
58%	3400055			231	836	653,764	653,764	66.9	\$373.56	628,772	0.9487	2,869	\$2,663	2,461	2,461
58%	3400023			390	1,086	735,893	735,893	86.9	\$402.12	700,949	0.6229	2,885	\$2,678	2,461	2,461
59%	3400151			1,348	4,719	3,040,497	3,040,497	377.5	\$335.66	2,913,785	0.7423	2,912	\$2,702	2,461	2,461
60%	3400064			716	2,257	1,505,742	1,505,742	180.6	\$323.51	1,447,316	0.6940	2,912	\$2,703	2,461	2,461
61%	3400067			272	853	619,272	619,272	68.2	\$406.63	591,526	0.7424	2,929	\$2,718	2,461	2,461
62%	3400050			1,788	7,361	4,490,982	4,490,982	588.9	\$240.70	4,349,233	0.8289	2,935	\$2,723	2,461	2,461
63%	3400130			843	2,549	1,669,333	1,669,333	203.9	\$382.33	1,591,376	0.6401	2,949	\$2,737	2,461	2,461
64%	3400088			238	710	521,365	521,365	56.8	\$247.61	507,301	0.7094	3,005	\$2,788	2,461	2,461
64%	3400109			686	2,547	1,576,499	1,576,499	203.8	\$285.43	1,518,329	0.7907	3,029	\$2,811	2,461	2,461
65%	3400147			1,098	4,692	3,246,142	3,246,142	375.4	\$294.64	3,135,534	0.9253	3,086	\$2,864	2,461	2,461
66%	3400104			2	9	4,667	4,667	0.7	\$274.46	4,475	0.7214	3,101	\$2,878	2,461	2,461
67%	3400027			1,191	4,912	3,063,743	3,063,743	393.0	\$336.00	2,931,695	0.7944	3,099	\$2,875	2,461	2,461
68%	3400053			513	2,341	1,966,394	1,966,394	187.3	\$497.97	1,873,124	1.1734	3,112	\$2,888	2,461	2,461
69%	3400039			692	2,379	1,814,368	1,814,368	190.3	\$440.73	1,730,497	0.8006	3,124	\$2,899	2,461	2,461
69%	3400158			264	899	636,064	636,064	71.9	\$381.46	608,637	0.7371	3,128	\$2,903	2,461	2,461
70%	3400041			602	1,762	1,391,438	1,391,438	141.0	\$377.11	1,338,265	0.7086	3,137	\$2,911	2,461	2,461
71%	3400047			1,805	13,833	15,594,040	10,832,847	1106.6	\$383.25	10,408,743	1.8307	3,150	\$2,923	2,461	3,475
72%	3400014	0.0324	0.0077	3,090	13,003	9,164,320	8,909,053	1040.2	\$336.52	8,459,005	0.8674	3,156	\$2,929	2,461	2,550
73%	3400004			1,469	5,518	3,955,418	3,955,418	441.4	\$360.66	3,796,223	0.8010	3,226	\$2,994	2,461	2,461
74%	3400143			976	2,751	2,467,864	2,467,864	220.1	\$445.53	2,369,803	0.7472	3,250	\$3,016	2,461	2,461
75%	3400009			2	5	6,368	6,368	0.4	\$683.72	6,095	0.9355	3,258	\$3,023	2,461	2,461
75%	3400146			4	17	18,976	18,976	1.4	\$876.96	17,748	1.3550	3,275	\$3,039	2,461	2,461
76%	3400032			1,633	5,976	4,285,104	4,285,104	478.1	\$361.84	4,112,108	0.7623	3,303	\$3,066	2,461	2,461

State Plan under Title XIX of the Social Security Act  
Medical Assistance Program  
State: NORTH CAROLINA

Payments for Medical and Remedial Care and Services: Inpatient Hospital

Exhibit 5.1

Psych/Rehab: Excluded

Provider Number	Provider Name	IME Factor	DME Factor	No. of Disch	No. of Days	Medicaid Cost	Cost Less Med Ed	Proj. Decline in Days	Routine Daily Cost	DRG Cost Less Med Ed	Vers. 12 CMI	Cost per CMI-Adj Disch.	Less Outl @ 7.2%	Base Rate	Rate with Med Ed
a	b	c	d	e	f	g	h=(1+e)(1+g)	i=j/g	k	l=j/k	m	n=k/m	o=(10.000) p	q	r=p*(1+q)
77% 3400012	Angol Community Hospital			88	409	280,544	280,544	32.7	\$374.37	268,302	0.9214	3,309	\$3,071	2,461	2,461
78% 3400142	Carteret General Hospital			562	2,179	1,563,094	1,563,094	174.3	\$287.98	1,512,899	0.8123	3,314	\$3,076	2,461	2,461
79% 3400005	C.A. Cannon Memorial Hospital			104	443	342,397	342,397	35.4	\$292.96	332,027	0.9601	3,325	\$3,086	2,461	2,461
80% 3400105	St. Joseph's Hospital	0.0081	0.0031	278	1,641	1,628,452	1,610,322	131.3	\$404.82	1,557,169	1.6502	3,394	\$3,150	2,461	2,489
81% 3400141	New Hanover Memorial Hospital	0.0609	0.0113	2,422	9,810	8,279,062	7,716,713	784.8	\$374.43	7,422,860	0.9024	3,396	\$3,152	2,461	2,639
81% 3400034	Alamance County Hospital			668	2,265	1,608,161	1,608,161	181.2	\$362.29	1,542,514	0.7560	3,054	\$2,834	2,461	2,461
82% 3400164	Highsmith-Rainey Hospital			191	1,216	1,030,803	1,030,803	97.3	\$436.46	988,336	1.5023	3,444	\$3,196	2,461	2,461
83% 3400116	Frye Regional Medical Center			312	1,439	1,416,275	1,416,275	115.1	\$356.62	1,375,205	1.2716	3,466	\$3,217	2,461	2,461
84% 3400114	Flex Hospital			172	897	775,302	775,302	71.8	\$386.92	752,957	1.2600	3,474	\$3,224	2,461	2,461
85% 3400030	Duke Univ. Medical Center	0.3681	0.0512	3,233	21,462	23,673,724	16,461,360	1717.0	\$442.73	15,701,193	1.3967	3,477	\$3,227	2,461	3,493
86% 3400144	Davis Hospital			536	1,537	1,272,845	1,272,845	123.0	\$390.56	1,224,606	0.6564	3,481	\$3,231	2,461	2,461
86% 3400155	Durham Regional Hospital	0.0483	0.0100	1,061	4,811	3,884,115	3,666,490	384.9	\$389.10	3,518,725	0.9502	3,490	\$3,239	2,461	2,604
87% 3400098	Mercy Hospital			353	1,651	1,551,913	1,551,913	132.1	\$438.08	1,494,042	1.2124	3,491	\$3,239	2,461	2,461
88% 3400091	Moses Cone Memorial	0.0357	0.0183	2,756	12,919	10,316,488	9,781,331	1033.5	\$427.89	9,339,106	0.9707	3,491	\$3,240	2,461	2,594
89% 3400002	Memorial Mission Hospital	0.0466	0.0070	2,436	11,025	9,765,507	9,265,817	882.0	\$458.71	8,861,234	1.0322	3,524	\$3,271	2,461	2,593
90% 3400107	Heritage Hospital			892	3,589	2,391,991	2,391,991	287.1	\$359.61	2,298,747	0.7270	3,524	\$3,271	2,461	2,461
91% 3400006	Scotland Health Group			950	4,785	2,780,168	2,780,168	382.8	\$371.72	2,637,674	0.7769	3,574	\$3,317	2,461	2,461
92% 3400162	Community Hospital-Rocky Mour			66	490	392,420	392,420	39.2	\$327.61	379,578	1.6028	3,588	\$3,330	2,461	2,461
92% 3400123	Randolph Hospital			384	992	966,715	966,715	79.4	\$414.60	933,795	0.6764	3,595	\$3,336	2,461	2,461
93% 3400067	Alexander County Hospital			42	133	158,460	158,460	10.6	\$460.69	153,577	1.0169	3,596	\$3,337	2,461	2,461
94% 3400125	Wesley Long Community			162	671	555,978	555,978	53.7	\$421.52	533,342	0.9121	3,610	\$3,350	2,461	2,461
95% 3400061	UNC Hospital	0.3813	0.0882	3,391	21,779	27,761,047	18,469,070	1742.3	\$503.30	17,592,170	1.4260	3,638	\$3,376	2,461	4,535
96% 3400094	Cape Fear Memorial			132	543	523,075	523,075	42.4	\$401.95	505,631	1.0402	3,683	\$3,417	2,461	2,461
97% 3400153	Orthopedic Hospital			29	163	259,185	259,185	13.0	\$425.65	253,652	2.3051	3,794	\$3,521	2,461	2,461
97% 3400113	Carolinas Medical	0.1420	0.0481	4,932	25,978	25,313,766	21,149,772	2078.2	\$408.59	20,300,640	1.0820	3,804	\$3,530	2,461	2,929
98% 3400001	Cabarrus Memorial Hospital			1,036	3,565	3,415,370	3,415,370	285.2	\$351.84	3,315,025	0.8334	3,840	\$3,563	2,461	2,461
99% 3400073	Raleigh Community Hospital			119	599	630,422	630,422	47.9	\$536.17	604,740	1.2596	4,034	\$3,744	2,461	2,461
100% 3400133	Martin General Hospital			163	641	567,625	567,625	51.3	\$417.09	546,228	0.7958	4,211	\$3,908	2,461	2,461
9999999	Out-of-State													2,461	2,461

State Plan under Title XIX of the Social Security Act  
Medical Assistance Program  
State: NORTH CAROLINA

Payments for Medical and Remedial Care and Services: Inpatient Hospital

108A-55. Payments.

(a) The Department may authorize, within appropriations made for this purpose, payments of all or part of the cost of medical and other remedial care for any eligible person when it is essential to the health and welfare of such person that such care be provided, and when the total resources of such person are not sufficient to provide the necessary care. When determining whether a person has sufficient resources to provide necessary medical care, there shall be excluded from consideration the person's primary place of residence and the land on which it is situated, and in addition there shall be excluded real property contiguous with the person's primary place of residence in which the property tax value is less than twelve thousand dollars (\$12,000).

(b) Payments shall be made only to intermediate care facilities, hospitals and nursing homes licensed and approved under the laws of the State of North Carolina or under the laws of another state, or to pharmacies, physicians, dentists, optometrists or other providers of health-related services authorized by the Department. Payments may also be made to such fiscal intermediaries and to the capitation or prepaid health service contractors as may be authorized by the Department. Arrangements under which payments are made to capitation or prepaid health services contracts are not subject to the provisions of Chapter 58 of the General Statutes or of Article 3 of Chapter 143 of the General Statutes.

(c) The Department shall reimburse providers of services, equipment, or supplies under the Medical Assistance Program in the following amounts:

- (1) The amount approved by the Centers for Medicare and Medicaid Services of the United States Department of Health and Human Services, if that Administration approves an exact reimbursement amount;
- (2) The amount determined by application of a method approved by the Centers for Medicare and Medicaid Services of the United States Department of Health and Human Services, if that Administration approves the method by which a reimbursement amount is determined, and not the exact amount.

The Department shall establish the methods by which reimbursement amounts are determined in accordance with Chapter 150B of the General Statutes. A change in a reimbursement amount becomes effective as of the date for which the change is approved by the Centers for Medicare and Medicaid Services of the United States Department of Health and Human Services.

(d) No payments shall be made for the care of any person in a nursing home or intermediate care home which is owned or operated in whole or in part by a member of the Social Services Commission, of any county board of social services, or of any board of county commissioners, or by an official or employee of the Department or of any county department of social services or by a spouse of any such persons. (1965, c. 1173, s. 1; 1969, c. 546, s. 1; 1971, c. 435; 1973, c. 476, s. 138, c. 644; 1975, c. 123; ss. 1, 2; 1977, 2ND Sess., c. 1219, c. 25; 1979, c. 702, s. 7; 1981, c. 275, s. 1; c. 849, s. 2; 1991, c. 388, s. 1; 1993, c. 529, s. 7.3)



State Plan under Title XIX of the Social Security Act  
Medical Assistance Program  
State: NORTH CAROLINA

Payments for Medical and Remedial Care and Services: Inpatient Hospital

**10A NCAC 21B .0406 DEDUCTIBLE**

(a) Deductible shall apply to a client in the following arrangements:

- (1) In the community, in private living quarters; or
- (2) In a residential group facility; or
- (3) In a long term care living arrangement when the client:
  - (A) Has enough income monthly to pay the Medicaid reimbursement rate for 31 days, but does not have enough income to pay the private rate plus all other anticipated medical costs; or
  - (B) Is under a sanction due to a transfer of resources as specified in Rule .0311 of this Subchapter; or
  - (C) Does not yet have documented prior approval for Medicaid payment of nursing home care; or
  - (D) Resided in a newly certified facility in the facility's month of certification; or
  - (E) Chooses to remain in a decertified facility beyond the last date of Medicaid payment; or
  - (F) Is under a Veterans Administration (VA) contract for payment of cost of care in the nursing home.

(b) The client or his representative shall be responsible for providing bills, receipts, insurance benefit statements or Medicare EOB to establish incurred medical expenses and his responsibility for payment. If the client has no representative and he is physically or mentally incapable of accepting this responsibility, the county shall assist him.

(c) Expenses shall be applied to the deductible when they meet the following criteria:

- (1) The expenses are for medical care or service recognized under state or federal tax law;
- (2) The are incurred by a budget unit member;
- (3) They are incurred:
  - (A) During the certification period for which eligibility is being determined and the requirements of Paragraph (d) of this Rule are met; or
  - (B) Prior to the certification period and the requirements of Paragraph (e) of this Rule are met.

(d) Medical expenses incurred during the certification period shall be applied to the deductible if the requirements in Paragraph (c) of this Rule are met and:

- (1) The expenses are not subject to payment by any third party including insurance, government agency or program except when such program is entirely funded by state or local government funds, or private source; or
- (2) The private insurance has not paid such expenses by the end of the application time standard; or
- (3) For certified cases, the insurance has not paid by the time that incurred expenses equal the deductible amount; or
- (4) The third party has paid and the client is responsible for a portion of the charges.

State Plan under Title XIX of the Social Security Act  
Medical Assistance Program  
State: NORTH CAROLINA

Payments for Medical and Remedial Care and Services: Inpatient Hospital

**10A NCAC 21B .0406 DEDUCTIBLE (continued)**

(e) The unpaid balance of a Medical expense incurred prior to the certification period shall be applied to the deductible if the requirements in Paragraph (c) of this Rule are met and:

- (1) The medical expense was:
  - (A) Incurred within 24 months immediately prior to:
    - (i) The month of application for prospective or retroactive certification period or both; or
    - (ii) The first month of any subsequent certification period; or
  - (B) Incurred prior to the period described in Subparagraph (e)(1)(A) of this Rule; and a payment was made on the bill during that period; and
- (2) The medical expense:
  - (A) Is a current liability;
  - (B) Has not been applied to a previously met deductible; and
  - (C) Insurance has paid any amount of the expense covered by the insurance.

(f) Incurred medical expenses shall be applied to the deductible in chronological order of charges except that:

- (1) If medical expenses for Medicaid covered services and non-covered services occur on the same date, apply charges for non-covered services first; and
- (2) If both hospital and other covered medical services are incurred on the same date, apply hospital charges first; and
- (3) If a portion of charges is still owed after insurance payment has been made for lump sum charges, compute incurred daily expense to be applied to the deductible as follows:
  - (A) Determine average daily charge excluding discharge date from hospitals; and
  - (B) Determine average daily insurance payment for the same number of days; and
  - (C) Subtract average daily insurance payment from the average daily charge to establish client's daily responsibility.

(g) Eligibility shall begin on the day that incurred medical expenses reduce the deductible to \$0, except that the client is financially liable for the portion of medical expenses incurred on the first day of eligibility that were applied to reduce the deductible to \$0. If hospital charges were incurred on the first day of eligibility, notice of the amount of those charges applied to meet the deductible shall be sent to the hospital for deduction on the hospital's bill to Medicaid.

(h) The receipt of proof of medical expenses and other verification shall be documented in the case record.

*History Note: Authority G.S. 108A-54; 42 C.F.R. 435.732; 42 C.F.R. 435.831; Alexander v. Flaherty, U.S.D.C., W.D.N.C., File Number C-C-74-483; Alexander v. Flaherty Consent Order filed February 14, 1992; Eff. September 1, 1984; Amended Eff. June 1, 1994; September 1, 1993; April 1, 1993; August 1, 1990.*

State Plan under Title XIX of the Social Security Act  
Medical Assistance Program  
State: NORTH CAROLINA

Payments for Medical and Remedial Care and Services: Inpatient Hospital

**10A NCAC 21B .0407 PATIENT LIABILITY**

(a) Patient liability shall apply to clients who live in facilities for skilled nursing, intermediate nursing, intermediate nursing for mental retardation or other medical institutions.

(b) The client's patient liability for cost of care shall be computed as a monthly amount after deducting the following from his total income:

- (1) An amount for his personal needs as established under Rule .0313 of this Subchapter;
- (2) Income given to the community spouse to provide him a total monthly income from all sources, equal to the "minimum monthly maintenance needs allowance" as defined in 42 U.S.C. 1396r-5(d)(3)(A)(i);
- (3) Income given to family members described in 42 U.S.C. 1396r-5(d)(1), to provide each, from all sources of income, a total monthly income equal to:
  - (A) One-third of the amount established under 42 U.S.C. 1396r-5(d)(3)(A)(i); or
  - (B) Where there is no community spouse, an amount for the number of dependents, based on the income level for the corresponding budget unit number, as approved by the NC General Assembly and stated in the Appropriations Act for categorically and medically needy classifications;
- (4) The income maintenance level provided by statute for a single individual in a private living arrangement with no spouse or dependents at home, for whom the physician of record has provided a written statement that the required treatment is such that the patient is expected to return home within six months, shall be allowed;
- (5) An amount for unmet medical needs as determined under Paragraph (f) of this Rule.

(c) Patient liability shall apply to institutional charges incurred from the date of admission or the first day of the month as appropriate and shall not be prorated by days if the client lives in more than one institution during the month.

(d) The county department of social services shall notify the client, the institution and the state of the amount of the monthly liability and any changes or adjustments.

(e) When the patient liability as calculated in Paragraph (b) of this Rule exceeds the Medicaid reimbursement rate for the institution for a 31 day month:

- (1) The patient liability shall be the institution's Medicaid reimbursement rate for a 31 day month;
- (2) The client shall be placed on a deductible determined in accordance with Federal regulations and Rules .0404, .0405 and .0406 of this Subchapter.

State Plan under Title XIX of the Social Security Act  
Medical Assistance Program  
State: NORTH CAROLINA

Payments for Medical and Remedial Care and Services: Inpatient Hospital

**10A NCAC 21B .0407 PATIENT LIABILITY (continued)**

(f) The amount deducted from income for unmet medical needs shall be determined as follows:

- (1) Unmet medical needs shall be the costs of:
  - (A) Medical care covered by the program but that exceeds limits on coverage of that care and that is not subject to payment by a third party;
  - (B) Medical care recognized under State and Federal tax law that is not covered by the program and that is not subject to payment by a third party; and
  - (C) Medicare and other health insurance premiums, deductibles, or coinsurance charges that are not subject to payment by a third party.
- (2) The amount of unmet medical needs deducted from the patient's monthly income shall be limited to monthly charges for Medicare and other health insurance premiums.
- (3) The actual amount of incurred costs which are the patient's responsibility shall be deducted when reported from the patient's liability for one or more months.
- (4) Incurred costs shall be reported by the end of the six month Medicaid certification period following the certification period in which they were incurred.

*History Note:* Authority G.S. 108A-54; 42 C.F.R. 435.732; 42 C.F.R. 435.733; 42 C.F.R. 435.831; 42 C.F.R. 435.832; 42 U.S.C. 1396r-5; Eff. September 1, 1984; Amended Eff. September 1, 1994; March 1, 1991; August 1, 1990; March 1, 1990.

State Plan under Title XIX of the Social Security Act  
Medical Assistance Program  
State: NORTH CAROLINA

Payments for Medical and Remedial Care and Services: Inpatient Hospital

**10A NCAC 22J .0101 PURPOSE AND SCOPE**

The purpose of these regulations is to specify the rights of providers to appeal reimbursement rates, payment denials, disallowances, payment adjustments and cost settlement disallowances and adjustments. Provider appeals for program integrity action are specified in 10A NCAC 22F.

*History Note:* Authority G.S. 108A-25(b); 108A-54; 150B-11; 42 U.S.C. 1396(b);  
Eff. January 1, 1988.

**10A NCAC 22J .0102 PETITION FOR RECONSIDERATION REVIEW**

(a) A provider may request a reconsideration review within 30 calendar days from receipt of final notification of payment, payment denial, disallowances, payment adjustment, notice of program reimbursement and adjustments and within 60 calendar days from receipt of notice of an institutional reimbursement rate. Final notification of payment, payment denial, disallowances and payment adjustment means that all administrative actions necessary to have a claim paid correctly have been taken by the provider and DMA or the fiscal agent has issued a final adjudication. If no request is received within the respective 30 or 60 day periods, the state agency's action shall become final.

(b) A request for reconsideration review must be in writing and signed by the provider and contain the provider's name, address and telephone number. It must state the specific dissatisfaction with DMA's action and should be mailed to: Appeals, Division of Medical Assistance at the Division's current address.

(c) The provider may appoint another individual to represent him. A written statement setting forth the name, address and telephone number of the representative so designated shall be sent to the above address. The representative may exercise any and all rights given the provider in the review process. Notice of meeting dates, requests for information, hearing decisions, etc. will be sent to the authorized representative. Copies of such documents will be sent to the petitioner only if a written request is made.

*History Note:* Authority G.S. 108A-25(b); 108A-54; 150B-11; 42 U.S.C. 1396(b);  
Eff. January 1, 1988.

State Plan under Title XIX of the Social Security Act  
Medical Assistance Program  
State: NORTH CAROLINA

Payments for Medical and Remedial Care and Services: Inpatient Hospital

**10A NCAC 22J .0103 RECONSIDERATION REVIEW PROCESS**

- (a) Upon receipt of a timely request for a reconsideration review, the Deputy Director shall appoint a reviewer or panel to conduct the review. DMA will arrange with the provider a time and date of the hearing. The provider must reduce his arguments to writing and submit them to DMA no later than 14 calendar days prior to the review. Failure to submit written arguments within this time frame shall be grounds for dismissal of the reconsideration, unless the Division within the 14 calendar day period agrees to a delay.
- (b) The provider will be entitled to a personal review meeting unless the provider agrees to a review of documents only or a discussion by telephone.
- (c) Following the review, DMA shall, within 30 calendar days or such additional time thereafter as specified in writing during the 30 day period, render a decision in writing and send it by certified mail to the provider or his representative.

*History Note:* Authority G.S. 108A-25(b); 108A-54; 150B-11; 42 U.S.C. 1396(b);  
Eff. January 1, 1988.

**10A NCAC 22J .0104 PETITION FOR A CONTESTED CASE HEARING**

If the provider disagrees with the reconsideration review decision he may request a contested case hearing in accordance with 10A NCAC 01.

*History Note:* Authority G.S. 108A-25(b); 108A-54; 150B-11; 42 U.S.C. 1396(b);  
Eff. January 1, 1988.

State Plan under Title XIX of the Social Security Act  
Medical Assistance Program  
State: NORTH CAROLINA

Payments for Medical and Remedial Care and Services: Inpatient Hospital

**10A NCAC 22B .0104 TIME LIMITATION**

(a) To receive payment, claims must be filed either:

- (1) Within 365 days of the date of service for services other than inpatient hospital, home health or nursing home services; or
- (2) Within 365 days of the date of discharge for inpatient hospital services and the last date of service in the month for home health and nursing home services not to exceed the limitations as specified in 42 C.F.R. 447.45; or
- (3) Within 180 days of the Medicare or other third party payment, or within 180 days of final denial, when the date of the third party payment or denial exceeds the filing limits in Subparagraphs (1) or (2) of this Rule, if it can be shown that:
  - (A) A claim was filed with a prospective third-party payor within the filing limits in Subparagraph (1) or (2) of this Rule; and
  - (B) There was a possibility of receiving payment from the third party payor with whom the claim was filed; and
  - (C) Bona fide and timely efforts were pursued to achieve either payment or final denial of the third-party claim.

(b) Providers must file requests for payment adjustments or requests for reconsideration of a denied claim no later than 18 months after the date of payment or denial of a claim.

(c) The time limitation specified in Paragraph (a) of this Rule may be waived by the Division of Medical Assistance when a correction of an administrative error in determining eligibility, application of court order or hearing decision grants eligibility with less than 60 days for providers to submit claims for eligible dates of service, provided the claim is received for processing within 180 days after the date the county department of social services approves the eligibility.

(d) In cases where claims or adjustments were not filed within the time limitations specified in Paragraphs (a) and (b) of this Rule, and the provider shows failure to do so was beyond his control, he may request a reconsideration review by the Director of the Division of Medical Assistance. The Director of Medical Assistance is the final authority for reconsideration reviews. If the provider wishes to contest this decision, he may do so by filing a petition for a contested case hearing in conformance with G.S. 150B-23.

*History Note: Authority G.S. 108A-25(b); 42 C.F.R. 447.45;  
Eff. February 1, 1976;  
Amended Eff. October 1, 1977;  
Readopted Eff. October 31, 1977;  
Amended Eff. June 1, 1993; June 1, 1988; November 1, 1986; July 1, 1985.*

State Plan under Title XIX of the Social Security Act  
Medical Assistance Program  
State: NORTH CAROLINA

Payments for Medical and Remedial Care and Services: Inpatient Hospital

The State has in place a public process which complies with the requirements of Section 1902(a)(13)(A) of the Social Security Act.

---

TN. No. 05-015  
Supersedes  
TN. No. New

Approval Date December 15, 2005

Eff. Date 10/01/2005



State Plan Under Title XIX of the Social Security Act  
Medical Assistance Program  
State: North Carolina

Payments for Medical and Remedial Care and Services: Inpatient Hospital

---

**INPATIENT PSYCHIATRIC FACILITY SERVICES FOR INDIVIDUALS UNDER 21 YEARS OF AGE**

The Division of Medical Assistance will negotiate prospective facility rates with private and public providers of psychiatric residential treatment facility services. Said negotiated prospective rates shall be based on reasonable cost. Reasonable costs are determined by the Division of Medical Assistance based upon the standards set in the HCFA-15 Provider Reimbursement Manual.

The per diem rates shall be adjusted annually for inflation. Rates shall be updated annually by the National Hospital Market Basket Index as published by Medicare and applied to the most recent actual and projected cost data available from the North Carolina Office of State Budget, Planning and Management.

---

TN. No. 05-015  
Supersedes  
TN. No. New

Approval Date December 15, 2005

Eff. Date 10/01/2005

State Plan Under Title XIX of the Social Security Act  
Medical Assistance Program

State: North Carolina

---

---

Citation

42 CFR 447, 434, 438, and 1902(a)(4), 1902(a)(6), and 1903

Payment Adjustment for Provider Preventable Conditions

The Medicaid agency meets the requirements of 42 CFR Part 447, Subpart A, and sections 1902(a)(4), 1902(a)(6), and 1903 with respect to non-payment for provider-preventable conditions.

Health Care-Acquired Conditions

The State identifies the following Health Care-Acquired Conditions for non-payment under Section 4.19 (A)

X Hospital-Acquired Conditions as identified by Medicare other than Deep Vein Thrombosis (DVT)/Pulmonary Embolism (PE) following total knee replacement or hip replacement surgery in pediatric and obstetric patients.

Effective January 1, 2011, Medicaid will make zero payment to providers for services related to Provider Preventable Conditions (PPC) which includes Healthcare Acquired Conditions (HCAC). Reimbursement for conditions described above is defined in Attachment 4.19A, Page 8a of this State Plan.

State Plan Under Title XIX of the Social Security Act  
Medical Assistance Program

State: North Carolina

---

Other Provider-Preventable Conditions

The State identifies the following Other Provider-Preventable Conditions for non-payment under Section(s) 4.19b

X Wrong surgical or other invasive procedure performed on a patient; surgical or other invasive procedure performed on the wrong body part; surgical or other invasive procedure performed on the wrong patient.

---

TN No. 11-001  
Supersedes  
TN No. NEW

Approval Date: Jan. 17, 2012

Eff. Date 01/01/2011

State Plan Under Title XIX of the Social Security Act  
Medical Assistance Program

State: North Carolina

---

---

  X   Additional Other Provider-Preventable Conditions identified below (please indicate the section(s)  
of the plan and specific service type and provider type to which the provisions will be applied.

---

TN No. 11-001  
Supersedes  
TN No. NEW

Approval Date: Jan. 17, 2012

Eff. Date 01/01/2011

State Plan Under Title XIX of the Social Security Act  
Medical Assistance Program  
State: North Carolina

Payment for Medical and Remedial Care and Services: Inpatient Hospital

---

Payment for Swing Beds and Lower Level Beds:

FY 2005 and 2006 – No rate increase from the June 30, 2005 rate for all Medicaid private and public providers with the following exceptions: federally qualified health clinics, rural health centers, state institutions, outpatient hospital, pharmacy and the non-inflationary components of the case-mix reimbursement system for nursing facilities.

NC General Assembly legislation mandates that effective July 1, 2005, reimbursement rates for these programs (Head Injury and Ventilator Nursing Beds) for the state fiscal years 2005-2006 and 2006-2007 will remain at the rate in effect as of June 30, 2005, except rates may be adjusted downward.

FY 2008-2009 – No Adjustment for Head and Vent Beds

FY 2009-2010 – The rates for SFY2010 are frozen as of the rates in effect July 1, 2009. Effective October 1, 2009, an overall rate reduction adjustment of 5.65% (annualized over 9 months) for Swing and Lower Level beds.

FY 2010-2011 – As of July 1, 2010, rates will be frozen as in effect June 30, 2010.

SFY 2012 – Rates will be frozen at the rate in effect on June 30, 2011. Effective October 1, 2011, existing rates are adjusted by a negative 2.67% to yield a twelve (12) month two percent (2%) budget reduction in the nine (9) remaining months of this State Fiscal Year.

SFY 2013 – Effective July 1, 2012, the rates will be adjusted such that they will equal 98% of the rate in effect July 1, 2011. There will be no further annual adjustments this state fiscal year

SFY 2014 – Effective August 1, 2013, rates will be frozen at the rates in effect June 30, 2013. There will be no further annual adjustment.

SFY 2015 – Effective July 1, 2014, rates will be frozen at the rate in effect June 30, 2014. There will be no further annual adjustments this state fiscal year.

Reference: Attachment 4.19-A, Page 25

---

TN. No. 13-032  
Supersedes  
TN. No. 11-038

Approval Date: 12/20/13

Eff. Date: 08/01/13

State Plan Under Title XIX of the Social Security Act  
Medical Assistance Program  
State: North Carolina

Payments for Medical and Remedial Care and Services: Inpatient Hospital

---

Payment for Inpatient Psychiatric Facility Services for Individuals Under 21 Years of Age:

SFY 2010 – The rates for SFY 2010 are frozen as of the rates in effect at July 1, 2009. Effective October 1, 2009, an overall program reduction of 4.29% was applied. There will be no further annual adjustment.

SFY 2011 – The rates for SFY 2011 are frozen as of the rates in effect at July 1, 2010. There will be no further annual adjustment.

SFY 2012 – Effective July 1, 2011, rates will be frozen at the rate in effect on June 30, 2011. Effective November 1, 2011, existing rates are adjusted by a negative 2.67% to yield a twelve (12) month two percent (2%) reduction in the nine (9) remaining months of this State Fiscal Year.

SFY 2013 – Effective July 1, 2012, the rates will be adjusted such that they will equal 98% of the rate in effect July 1, 2011. There will be no further annual adjustments this state fiscal year.

SFY 2014 – Effective August 1, 2013, the rates will be frozen at the rates in effect on June 30, 2013. There will be no further annual adjustment.

SFY 2015 – Effective July 1, 2014, rates will be frozen at the rate in effect on June 30, 2014. There will be no further annual adjustments this state fiscal year.

Reference: Attachment 4.19-A: Page 44

---

TN. No. 13-014  
Supersedes  
TN. No. 11-015

Approval Date: Dec 05 2013

Eff. Date: 8/1/2013

State Plan Under Title XIX of the Social Security Act  
Medical Assistance Program

State: NORTH CAROLINA

---

---

Inpatient Hospital:

SFY 2012 – Rates will be frozen at the rate in effect on June 30, 2011. Effective October 1, 2011, existing hospital rates are adjusted by a negative 9.80%, and non-state-owned freestanding psychiatric and rehabilitation hospitals existing rates are adjusted by a negative 2.67%.

SFY 2013 – Effective July 1, 2012, the hospital rates will be adjusted such that they will equal 92.68% of the rate in effect on June 30, 2011, and non-state-owned freestanding psychiatric and rehabilitation hospitals rates will be adjusted such that they will equal 98% of the rate in effect on June 30, 2011. There will be no further annual adjustments this state fiscal year.

SFY 2014 – Base DRG rates, Base Psychiatric per diem rates, and Base Rehabilitative per diem rates will be frozen at the rate in effect on June 30, 2013. Effective January 1, 2014, the hospital base rates will be adjusted such that they will equal 97% of the rate in effect on June 30, 2013. There will be no further annual adjustments this state fiscal year.

SFY 2016 – Effective July 1, 2015, the rates are frozen at the rate in effect as of June 30, 2015. There will be no further annual adjustments this state fiscal year.

Reference: Attachment 4.19-A, Page 4

---

TN. No. 14-046  
Supersedes  
TN. No. 14-013

Approval Date: 05-26-15

Eff. Date: 01/01/2015

State Plan Under Title XIX of the Social Security Act  
Medical Assistance Program  
State: NORTH CAROLINA

---

Hospital Acquired Condition (HAC) Never Events (NE) / Present on Admission (POA)

For dates of service January 1, 2011 and after, for all Medicaid patients, requests for Diagnosis Related Groups (DRGs) attributable to Medicare identified hospital acquired conditions and never events will not be approved by the Peer Review Organization (PRO) and are not reimbursable. PRO review for present on admission is not required. This policy applies to all Medicaid reimbursement provisions, contained in Attachment 4.19-A, including Medicaid supplemental or enhanced payments and Medicaid disproportionate share hospital payments and complies with Medicare Billing Guidelines for Hospital Acquired Conditions, Never Events and Present on Admission.

---

TN. No. 11-001  
Supersedes  
TN. No. NEW

Approval Date: Jan. 17, 2012

Eff. Date: 01/01/2011



MEDICAL ASSISTANCE  
State: NORTH CAROLINA

PAYMENTS FOR MEDICAL AND REMEDIAL CARE AND SERVICE

---

1. Inpatient hospital services other than those provided in an institution for mental diseases.  
Described in Attachment 4.19-A
2. Payments for Medicare Part A inpatient deductible.  
Described in Attachment 4.19-A (Rates will be paid in strict accordance with the State Plan under 4.19-A)

MEDICAL ASSISTANCE  
State: NORTH CAROLINA

PAYMENTS FOR MEDICAL AND REMEDIAL CARE AND SERVICE

---

---

Payment for Hospital Acquired Conditions:

Effective January 1, 2011 and in accordance with Title XIX of the Social Security Act – Sections 1902, 1903 and 42 CFRs 434, 438, and 447, Medicaid will make no payment to providers for services related to Provider Preventable Conditions (PPC) which includes Never Events (NE), Other Provider Preventable Conditions (OPPCs) and Additional Other Provider-Preventable Conditions (AOPPC).

In accordance with N.C. State Plan, Attachment 3.1-A, Page 1, Hospital Services payments are allowed except for the following conditions outlined below.

Never Events (NE) are defined by the National Coverage Determination (NCD) manual for Outpatient Hospitals, Ambulatory Surgical Centers (ASC) and practitioners, and these providers will be required to report NEs. Outpatient Hospital claims must bill separate a claim as a Bill Type 130 or as designated by the National Uniform Bill Committee for a non-payment/zero claim.

Ambulatory Surgical Centers (ASC) and their practitioners are included in the category of Other Provider Preventable Conditions (OPPC) claims. Never Events (NE) for Ambulatory Surgical Centers (ASC) and practitioners (AOPPC) are required to append one of the following applicable NCD modifiers to all lines related to the erroneous surgery(s).

- PA: Surgery Wrong Body Part
- PB: Surgery Wrong Patient
- PC: Wrong Surgery on Patient

Practitioners are defined in Attachment 4.19-B - Section 5, Section 6 and Section 17.

The provider may file a separate claim for the same Medicaid recipient with the same dates of service to include the allowable charges for reimbursement. Providers must identify and report NE occurrences.

Prohibition on payments for NEs, OPPCs, and AOPPCs shall not result in a loss of access to care or services for Medicaid beneficiaries. This policy applies to all Medicaid reimbursement provisions contained in 4.19B.

State Plan Under Title XIX of the Security Act  
Medical Assistance Program

Attachment 4.19-B  
Section 1, Page 3

State: North Carolina

---

Citation

42 CFR 447, 434, 438, and 1902(a)(4), 1902(a)(6), and 1903

Payment Adjustment for Provider Preventable Conditions

The Medicaid agency meets the requirements of 42 CFR Part 447, Subpart A, and sections 1902(a)(4), 1902(a)(6), and 1903 with respect to non-payment for provider-preventable conditions.

Health Care-Acquired Conditions

The State identifies the following Health Care-Acquired Conditions for non-payment under Section 4.19 (A)

X Hospital-Acquired Conditions as identified by Medicare other than Deep Vein Thrombosis (DVT)/Pulmonary Embolism (PE) following total knee replacement or hip replacement surgery in pediatric and obstetric patients.

Effective January 1, 2011, Medicaid will make zero payment to providers for services related to Provider Preventable Conditions (PPC) which includes Healthcare Acquired Conditions (HCAC). Reimbursement for conditions described above is defined in Attachment 4.19-A, Page 8a of this State Plan.

---

TN No. 11-001  
Supersedes  
TN No. NEW

Approval Date: Jan. 17, 2012

Effective Date: 01/01/2011

CMS ID: 7982E

State Plan Under Title XIX of the Security Act  
Medical Assistance Program

Attachment 4.19-B  
Section 1, Page 4

State: North Carolina

---

Citation

42 CFR 447, 434, 438, and 1902(a)(4), 1902(a)(6), and 1903

Payment Adjustment for Provider Preventable Conditions

The Medicaid agency meets the requirements of 42 CFR Part 447, Subpart A, and sections 1902(a)(4), 1902(a)(6), and 1903 with respect to non-payment for provider-preventable conditions.

Other Provider-Preventable Conditions

The State identifies the following Other Provider-Preventable Conditions for non-payment under Section 4.19 (B) of this State plan.

X Wrong surgical or other invasive procedure performed on a patient; surgical or other invasive procedure performed on the wrong body part; surgical or other invasive procedure performed on the wrong patient.

On and after the above effective date, Medicaid will make zero payments to providers for Other Provider-Preventable Conditions which includes Never Events (NE) as defined by the National Coverage Determination (NCD). The Never Events (NE) as defined in the NCD includes Inpatient Hospitals, Outpatient Hospitals, Ambulatory Surgical Centers (ASC) and practitioners, and these providers will be required to report NEs. Reimbursement for conditions described above is defined in Attachment 4.19-B, Section 1, Page 2, of this State Plan.

---

TN No. 11-001  
Supersedes  
TN No. NEW

Approval Date: Jan. 17, 2012

Effective Date: 01/01/2011

CMS ID: 7982E

State Plan Under Title XIX of the Social Security Act  
Medical Assistance Program

Attachment 4.19-B  
Section 1 Page 5

State: NORTH CAROLINA

---

\_\_\_\_ Additional Other Provider-Preventable Conditions identified below (please indicate the section(s) of the plan and specific service type and provider type to which the provisions will be applied).

---

TN No. 11-001  
Supersedes  
TN No. NEW

Approval Date: Jan. 17, 2012

Effective Date: 01/01/2011

CMS ID: 7982E

MEDICAL ASSISTANCE  
State: NORTH CAROLINA

PAYMENTS FOR MEDICAL AND REMEDIAL CARE AND SERVICE

---

Payment for Hospital Acquired Conditions:

Effective January 1, 2011 and in accordance with Title XIX of the Social Security Act – Sections 1902, 1903 and 42 CFRs 434, 438, and 447, Medicaid will make no payment to providers for services related to Provider Preventable Conditions (PPC) which includes Never Events (NE), Other Provider Preventable Conditions (OPPCs) and Additional Other Provider-Preventable Conditions (AOPPC).

In accordance with N.C. State Plan, Attachment 3.1-A, Page 1, Hospital Services payments are allowed except for the following conditions outlined below.

Never Events (NE) are defined by the National Coverage Determination (NCD) manual for Outpatient Hospitals, Ambulatory Surgical Centers (ASC) and practitioners, and these providers will be required to report NEs. Outpatient Hospital claims must bill separate a claim as a Bill Type 130 or as designated by the National Uniform Bill Committee for a non-payment/zero claim.

Ambulatory Surgical Centers (ASC) and their practitioners are included in the category of Other Provider Preventable Conditions (OPPC) claims. Never Events (NE) for Ambulatory Surgical Centers (ASC) and practitioners (AOPPC) are required to append one of the following applicable NCD modifiers to all lines related to the erroneous surgery(s).

- PA: Surgery Wrong Body Part
- PB: Surgery Wrong Patient
- PC: Wrong Surgery on Patient

Practitioners are defined in Attachment 4.19-B - Section 5, Section 6 and Section 17.

The provider may file a separate claim for the same Medicaid recipient with the same dates of service to include the allowable charges for reimbursement. Providers must identify and report NE occurrences.

Prohibition on payments for NEs, OPPCs, and AOPPCs shall not result in a loss of access to care or services for Medicaid beneficiaries. This policy applies to all Medicaid reimbursement provisions contained in 4.19B.

---

TN No. 11-001  
Supersedes  
TN No. NEW

Approval Date Jan. 17, 2012

Eff. Date 01/01/2011

State Plan Under Title XIX of the Social Security Act  
Medical Assistance Program  
State: NORTH CAROLINA

PAYMENTS FOR MEDICAL AND REMEDIAL CARE AND SERVICE

---

**2.a.1. ENHANCED PAYMENTS FOR OUTPATIENT HOSPITAL SERVICES**

Hospitals that are licensed by the State of North Carolina, are not qualified to certify expenditures and that received payment for more than 50 percent of their Medicaid inpatient discharges under the DRG methodology for the most recent 12-month period ending September 30, shall be entitled to the following enhanced payments, for outpatient services for the 12-month period ending September 30 of each year, paid annually in up to four installments.

**Base Enhanced Payments:**

- (1) The base enhanced payment to hospitals shall equal a percent, not to exceed the State's federal financial participation rate in effect for the period, for which the payment is being calculated, of the hospital's outpatient "Medicaid deficit." At least 10 calendar days in advance of the first payment of the payment plan year, the Division will determine, and notify eligible hospitals of, the percent of the outpatient "Medicaid deficit" to be paid as the base enhanced payment for outpatient services.
- (2) The "Medicaid deficit" is calculated as follows:
  - A. Reasonable costs of outpatient hospital Medicaid services shall be determined annually by calculating a hospital's Medicaid outpatient cost-to-charge ratio using the most recent available as-filed hospital fiscal year CMS 2552 cost report data available before payments are calculated and multiplying the Medicaid outpatient cost-to-charge ratio by the hospital's Medicaid allowable charges for outpatient services provided during the same fiscal year as the filed cost report and paid not less than six months after the end of the fiscal year .
  - B. Applying an inflation factor calculated based on the most current information available at the time on the CMS website for the CMS PPS Hospital Input Price Index to bring the cost data forward to the mid-point of the payment period.
  - C. Multiplying the Medicaid outpatient costs by a percentage equal to 100 minus the percent of allowable outpatient costs specified in Section 2a on Page 1 above.

**Equity Enhanced Payments:**

- (1) The Equity enhanced payment shall, when added to the enhanced payment described in Paragraph 2.A.1 of this Section, equal one hundred percent of the hospital's outpatient "Medicaid deficit" as that term is defined in Subparagraph 2.a.1(2) of this Section 2.
- (2) Assessments collected under this section are considered an allowable cost and are not subject to cost settlement.

State Plan Under Title XIX of the Social Security Act  
Medical Assistance Program  
State: NORTH CAROLINA

PAYMENTS FOR MEDICAL AND REMEDIAL CARE AND SERVICE

---

---

Payments calculated under Paragraph 2.a.1. (when added to other Medicaid payments received or to be received for these services) shall not cause aggregate payments to any category of hospitals as specified in 42 CFR 447.321 to exceed the maximum allowed aggregate upper limits for that category established by applicable federal law and regulation.

The payments authorized under Paragraph (e) shall be effective in accordance with GS 108A-55(c).



MEDICAL ASSISTANCE  
STATE: NORTH CAROLINA

PAYMENTS FOR MEDICAL AND REMEDIAL CARE AND SERVICE

---

---

**2.a.2. ENHANCED PAYMENTS TO TEACHING HOSPITALS FOR OUTPATIENT HOSPITAL SERVICES**

Hospitals that are not qualified to certify, are licensed by the State of North Carolina, qualify for disproportionate share hospital status under Paragraph (c) of the Disproportionate Share Hospital payment section of this plan, and, for the fiscal year immediately preceding the period for which payments under this Paragraph are being calculated:

- i. Qualify to receive inpatient hospital rate adjustment payments described in Paragraph (g) of the section of this plan entitled “INPATIENT HOSPITAL RATE ADJUSTMENT PAYMENT TO HOSPITALS SERVING HIGH PORTIONS OF LOW INCOME PATIENTS;” and
- ii. Operate at least two Medicare approved graduate medical education programs and report on cost reports filed with the Division, Medicaid costs attributable to such programs; shall be entitled to additional enhanced payments for outpatient services, paid annually in up to four installments.
  - (1) The additional enhanced payment for Medicaid outpatient services shall satisfy the portion of the outpatient “Medicaid deficit” equal to 7.22 percent of the hospital’s estimated uncompensated care cost of providing inpatient and outpatient services to uninsured patients
  - (2) The outpatient “Medicaid deficit” shall be calculated as follows:
    - A. Reasonable costs of outpatient hospital Medicaid services shall be determined annually by calculating a hospital’s Medicaid outpatient cost-to-charge ratio using the most recent available as-filed CMS 2552 cost report data and multiplying the Medicaid outpatient cost-to-charge ratio by the hospital’s Medicaid allowable charges for outpatient services provided during the same fiscal year as the filed cost report, but paid not less than six months after the end of the fiscal year,
    - B. Applying the applicable CMS PPS Hospital Input Price Indices to bring the cost data forward to the mid-point of the payment period.
    - C. Multiplying the Medicaid outpatient costs by a percentage equal to 100 minus the percent of allowable outpatient costs specified in Section 2a on Page 1 above.

MEDICAL ASSISTANCE  
STATE: NORTH CAROLINA

PAYMENTS FOR MEDICAL AND REMEDIAL CARE AND SERVICE

---

- (3) Uncompensated care costs are calculated using hospitals' gross charges for services provided to uninsured patients as filed with and certified to the Division for the same fiscal year as the CMS cost report used in determining reasonable cost in 2. A. above. The Division shall convert hospitals' gross charges for uninsured patients to costs by multiplying them by a cost-to-charge ratio determined using hospitals' most recent available as-filed CMS 2552 cost reports for the same fiscal year used in 2.A. and then subtracting payments hospitals received from uninsured patients.
- (4) Payments under Paragraph 2.a.2.(when added to Medicaid payments received or to be received for these services) shall not cause aggregate payments to any category of hospitals as specified in 42 CFR 447.321 to exceed the maximum allowed aggregate upper limits for that category established by applicable federal law and regulation.
- (5) The payments authorized under Paragraph 2.a.1. and 2.a.2. shall be effective in accordance with GS 108A-55(c).

---

TN. No. 06-008  
Supersedes  
TN. No. 05-015

Approval Date **SEP 21 2006**

Eff. Date 10/01/2006

State Plan Under Title XIX of the Social Security  
Act Medical Assistance Program  
State: NORTH CAROLINA

Payments for Medical and Remedial Care and Services: Inpatient Hospital

---

---

2.a.3. OUTPATIENT HOSPITAL SERVICES BY UNIVERSITY OF NORTH CAROLINA  
HOSPITALS

In addition to the payments made elsewhere in this plan, hospitals owned or controlled by the University of North Carolina Health Care System, as defined in N.C. Gen. Stat. § 116-37, are eligible for supplemental payments for all outpatient hospital services, excluding outpatient laboratory services. For a hospital eligible under this is in addition to the payment in this subparagraph supersedes the requirement, in Paragraph 2.a. of this Section, that such a hospital be paid 70 percent of their allowable costs.

The total payment available for hospitals eligible under this subparagraph will be determined by aggregating the difference between what would be paid under Medicare payment principles for each eligible hospital's Medicaid fee-for-service outpatient hospital charges, i.e. each hospital's upper payment limit, and the outpatient Medicaid payments as otherwise calculated under this State Plan. Since Medicare reasonable cost principles will be used to estimate what would be paid under Medicare payment principles, each hospital's upper payment limit will be Medicaid cost. For each eligible hospital, both Medicaid cost and Medicaid payments will be estimated using data from the latest available Medicare cost report and a Medicaid PS&R for the same year as the Medicare cost report and run no less than nine (9) months after the close of the cost report year.

Medicaid cost will be determined by applying a cost to charge ratio from the Medicare cost report to the Medicaid charges on the PS&R and inflating into the current fiscal year using the CMS PPS hospital market basket index. Medicaid payments will be taken from the Medicaid PS&R and inflated into the current fiscal year using the CMS PPS hospital market basket index.

The total calculated supplemental payment amount will be paid to eligible hospitals in payments made no more frequently than each quarter.

If payments in this section would result in payments to any category of hospitals in excess of the upper payment limit calculation required by 42 C.F.R. 447.321, payments for each eligible hospital receiving payments under this section will be reduced proportionately to ensure compliance with the upper payment limit.

PAYMENTS FOR MEDICAL AND REMEDIAL CARE AND SERVICE

---

- 2.b. Rural health clinic (RHC) services and other ambulatory services furnished by a rural health clinic. Subparagraph (1) through (5) conform to the provisions of the Benefits Improvement and Protection Act of 2000.
- (1) Effective for dates of service occurring January 1, 2001 and after, RHCs are reimbursed on a prospective payment rate. The initial rate is equal to 100 per cent of their average reasonable costs of Medicaid covered services provided during the clinic's fiscal years 1999 and 2000, adjusted to take into account any increase (or decrease) in the scope of services furnished during fiscal year 2001 by the RHC (calculating the payment amount on a per visit basis).
- (A) In determining the initial PPS rate, cost caps for core services shall continue to be used to determine reasonable cost, as established by Medicare.
- (B) The clinic's average fiscal years 1999 and 2000 cost shall be calculated by adding the total reasonable costs together for fiscal year 1999 and fiscal year 2000 and dividing by the number of visits.
- (C) A visit means a face-to-face encounter between an RHC patient and any health professional whose services are reimbursed under the State Plan.
- (D) In the case of any RHC participating with a licensed Medicaid managed care organization, and receiving either PPS or cost based reimbursement, quarterly reconciliation will occur with supplemental payments made no less frequently than every four months to the clinic for the difference between the payment amounts paid by the managed care organization and the amount to which the clinic is entitled under the prospective payment system. A final annual reconciliation of any supplemental payments will be completed at the end of the RHCs' fiscal year upon determination of the final cost based or PPS rate for the period.

PAYMENTS FOR MEDICAL AND REMEDIAL CARE AND SERVICE

---

- (2) At the beginning of each clinic's fiscal year, subsequent to January 1, 2001, the rates shall be increased by the percentage increase in the Medicare Economic Index for primary care services and adjusted to take into account any increase (decrease) in the scope of services furnished during that fiscal year.
  - (A) A rate adjustment due to change in the scope of services must be supported by the preponderance of evidence by the provider.
  - (B) The Division of Medical Assistance shall make rate adjustments due to change in the scope of services.
  - (C) The MEI rate adjustment shall take effect on the first day of the provider's fiscal year.
  - (D) Rates may also be adjusted to take into consideration reasonable changes in the industry's cost of service.
- (3) Newly qualified RHCs after December 31, 2000, will have their initial rates established either by reference to rates paid to other clinics in the same or adjacent areas with similar caseload, or in the absence of such other clinics, through cost reporting methods. Rates for subsequent fiscal years shall be based on the same update methods reflected in subparagraph (2) above.

Alternative Payments

- (4) Providers who elected to be reimbursed in accordance to the cost based methodology in effect on December 31, 2000, and who did not change their election prior to January 1, 2005 shall remain with that choice of cost based reimbursement methodology.
  - (A) Rates paid under this cost based reimbursement methodology must be at least equal to the payment under the payment methodology included in subparagraphs (1) and (2). To ensure providers receive no less under the cost based reimbursement methodology than under PPS, the actual amount received under cost based reimbursement is compared to the amount a provider would have received under PPS.

PAYMENTS FOR MEDICAL AND REMEDIAL CARE AND SERVICE

---

- (B) Provider clinics are paid on the basis of the principles and at the Medicare determined rates specified in the Medicare regulation in Part 405, Subpart D not to exceed the Medicare established limits. For Medicaid only services, the interim rates are based on a Medicaid fee schedule.
- (C) Independent clinics are paid for all core services offered by the clinic at a single cost-reimbursement rate for clinic visit, established by the Medicare carrier, which includes the cost of all core services furnished by the clinic.
- (D) Effective October 1, 1993, physician-provided services at a hospital inpatient or an outpatient location are paid at the existing fee-for-service rate only to those clinics whose agreement with their physician states that the clinic does not compensate the physician for services in a location other than at the rural health clinic location.
- (E) If the Core Service Provider Number has a Change of Ownership, the new provider will be reimbursed under the PPS methodology established in paragraph (3) above.

Enhanced Reimbursement for Pregnancy Medical Home Services will be made to RHC providers as specified in Attachment 3.1-B, Page 7(a) and Attachment 3.1-F. The Pregnancy Medical Home will be paid these enhanced payments in additional to their regular reimbursement.

Two enhanced payments may be made to RHCs for services provided by a Pregnancy Medical Home. Upon completion of the high risk screening, an enhanced payment of \$50.00 will be made to the PMH. Upon completion of the recipient's post partum visit, an enhanced payment of \$150.00 will be made to the PMH provider. The PMH provider will receive a maximum of \$200 enhanced payments per recipient per pregnancy even if there are multiple births.

Additionally, the PMH provider receives an enhanced rate for a vaginal delivery by paying the same rate for the vaginal delivery as for an uncomplicated c-section. Only the physician rates for the delivery codes are enhanced. The enhanced rates were determined by applying a 13.2% increase to the NC Medicaid Physician Fee Schedule rate as established in Attachment 4.19-B Section 5, Page 1 of the State Plan.

There shall be no cost settlement for any provider in any setting for these services reimbursed at the enhanced rates.

Notwithstanding any other provision, if specified, these rates will be adjusted as shown on Attachment 4.19-B, Supplement 3, Page 1 of the State Plan.

PAYMENTS FOR MEDICAL AND REMEDIAL CARE AND SERVICE

---

- 2.c. Federally qualified health center (FQHC) services and other ambulatory services furnished by a federally qualified health center. Subparagraph (1) through (5) conform to the provisions of the Benefits Improvement and Protection Act of 2000.
- (1) Effective for dates of service occurring January 1, 2001 and after, FQHCs are reimbursed on a prospective payment rate. The initial rate is equal to 100 per cent of their average reasonable costs of Medicaid covered services provided during the center's fiscal years 1999 and 2000, adjusted to take into account any increase (or decrease) in the scope of services furnished during fiscal year 2001 by the FQHC (calculating the payment amount on a per visit basis).
- (A) In determining the initial PPS rate, cost caps for core services shall continue to be used to determine reasonable cost, as established by Medicare.
- (B) The center's average fiscal years 1999 and 2000 cost shall be calculated by adding the total reasonable costs together for fiscal year 1999 and fiscal year 2000 and dividing by the number of visits.
- (C) A visit means a face-to-face encounter between an FQHC patient and any health professional whose services are reimbursed under the State Plan.
- (D) In the case of any FQHC participating with a licensed Medicaid managed care organization and receiving either PPS or cost based reimbursement, quarterly reconciliation will occur with supplemental payments made no less frequently than every four months to the center for the difference between the payment amounts paid by the managed care organization and the amount to which the center is entitled under the prospective payment system. A final annual reconciliation of any supplemental payments will be completed at the end of the FQHCs' fiscal year upon determination of the final cost based or PPS rate for the period.

PAYMENTS FOR MEDICAL AND REMEDIAL CARE AND SERVICE

---

- (2) At the beginning of each center's fiscal year, subsequent to January 1, 2001, the rates shall be increased by the percentage increase in the Medicare Economic Index for primary care services and adjusted to take into account any increase (decrease) in the scope of services furnished during that fiscal year.
- (A) A rate adjustment due to change in the scope of services must be supported by the preponderance of evidence by the provider.
- (B) The Division of Medical Assistance shall make rate adjustments due to change in the scope of services.
- (C) The MEI rate adjustment shall take effect on the first day of the provider's fiscal year.
- (D) Rates may also be adjusted to take into consideration reasonable changes in the industry's cost of service.
- (3) Newly qualified FQHCs after December 31, 2000, will have their initial rates established either by reference to rates paid to other centers in the same or adjacent areas with similar caseload, or in the absence of such other centers, through cost reporting methods. Rates for subsequent fiscal years shall be based on the same update methods reflected in subparagraph (2) above.



---

PAYMENTS FOR MEDICAL AND REMEDIAL CARE AND SERVICE

---

Alternative Payments

- (4) Providers who elected to be reimbursed in accordance to the cost based methodology in effect on December 31, 2000, and who did not change their election prior to January 1, 2005 shall remain with that choice of cost based reimbursement methodology.
- (A) Rates paid under this cost based reimbursement methodology must be at least equal to the payment under the payment methodology included in subparagraphs (1) and (2). To ensure providers receive no less under the cost based reimbursement methodology than under PPS, the actual amount received under cost based reimbursement is compared to the amount a provider would have received under PPS.
- (B) Services furnished by a federally qualified health center (FQHC) are reimbursed at one hundred percent (100%) of reasonable cost, not to exceed the Medicare established limits, as determined in an annual cost report, based on Medicare principles and methods (for Medicaid only services, the interim rates are based on a Medicaid fee schedule) when:
- (1) It is receiving a grant under Section 329 (migrant health centers), 330 (community health centers) or 340 (health care centers for the homeless), Public Housing Health Centers receiving grant funds under Section 340A of the Public Health Service Act and Urban Indian organizations receiving funds under Title V of the Indian Health Improvement Act are FQHC's effective calendar quarter beginning or after October 1, 1993;
  - (2) It meets the requirements for receiving a Public Health Service grant or was treated as a comprehensive federally funded health center as of January 1, 1990.
  - (3) Nutrition services are provided by RHC's and FQHC. Providers are reimbursed in accordance with reimbursement methodologies established for services provided by RHC's and FQHCs as based on Medicare principles.
  - (4) Effective October 1, 1993, physician-provided services at a hospital inpatient and an outpatient location are paid at the existing fee-for-service rate only to those clinics whose agreement with their physician states that the clinic does not compensate the physician for services in a location other than at the federally qualified health clinic location.
- (C) If the Core Service Provider Number has a Change of Ownership, the new provider will be reimbursed under the PPS methodology established in paragraph (3) above.

PAYMENTS FOR MEDICAL AND REMEDIAL CARE AND SERVICE

---

Alternative Payments

Enhanced Payments for Pregnancy Medical Home Services will be made to FQHC providers as specified in Attachment 3.1-B, Page 7(a) and Attachment 3.1-F. The Pregnancy Medical Home will be paid these enhanced payments in addition to their regular reimbursement.

- (5) Two enhanced payments may be made to FQHCs for services provided by a Pregnancy Medical Home. Upon completion of the high risk screening, an enhanced payment of \$50.00 will be made to the PMH. Upon completion of the recipient's post partum visit, an enhanced payment of \$150.00 will be made to the PMH provider. The PMH provider will receive a maximum of \$200 enhanced payments per recipient per pregnancy even if there are multiple births.

Additionally, the PMH provider receives an enhanced rate for a vaginal delivery by paying the same rate for the vaginal delivery as for an uncomplicated c-section. Only the physician rates for the delivery codes are enhanced. The enhanced rates were determined by applying a 13.2% increase to the NC Medicaid Physician Fee Schedule rate as established in Attachment 4.19-B Section 5, Page 1 of the State Plan.

There shall be no cost settlement for any provider in any setting for these services reimbursed at the enhanced rates.

Notwithstanding any other provision, if specified, these rates will be adjusted as shown on Attachment 4.19-B, Supplement 3, Page 1 of the State Plan.

MEDICAL ASSISTANCE  
State: NORTH CAROLINA

PAYMENTS FOR MEDICAL AND REMEDIAL CARE AND SERVICE

---

---

3. Laboratory and X-ray Services

Fees for independent laboratory services shall be the lower of the submitted charge or the appropriate fee from the fee schedule in effect on July 1, 1990.

- a. Annual fees are increased each January 1, based on the forecast of the Gross National Product (GNP) implicit price deflator, but not to exceed the percentage increase granted by the N.C. State Legislature and not to exceed the Medicare maximum fees.
- b. Fees for new services are established based on fees for similar existing services. If there are no similar services the fee is set at the Medicare maximum fee. If there is no Medicare fee available, the fee is established at 60 percent of charges until a Medicare fee is established.

The above methodology shall also apply to laboratory services paid to hospital outpatient facilities, physicians, and any provider supplying outpatient laboratory services.

Services reimbursed under the above methodology are not subject to cost settlement.

Notwithstanding any other provision, if specified, these rates will be adjusted as shown on Attachment 4.19-B, Supplement 3, Page 1b of the State Plan.

MEDICAL ASSISTANCE  
State: NORTH CAROLINA

PAYMENTS FOR MEDICAL AND REMEDIAL CARE AND SERVICE

---

---

- 4.a. Skilled nursing facility services (other than services in an institution for mental diseases) for individuals 21 years of age or older.

Described in 4.19-D

---

TN. No. 88-12  
Supersedes  
TN. No. NEW

Approval Date 6/9/89

Receipt Date 9/21/88  
Eff. Date 7/1/88

MEDICAL ASSISTANCE  
State: NORTH CAROLINA

PAYMENTS FOR MEDICAL AND REMEDIAL CARE AND SERVICE

---

- 4.b. Health Check Services / Early and Periodic Screening and Diagnosis of individuals under 21 years of age, and treatment of conditions found.

Health Check Services provide early and regular preventive medical and dental screenings. Except as otherwise noted in the plan, state-developed fee schedule rates are the same for both governmental and private providers of Health Check Services. The agency's fee schedule rates were set as of July 1, 2010 and are effective for services provided on or after that date. The Fee schedule is published on the agency's website at <http://www.ncdhhs.gov/dma/fee/fee.htm>. Providers will be reimbursed the lower of the fee schedule rate or their usual and customary charge.

Health Check services will be provided by direct enrolled Medicaid providers who may be either governmental or private providers. Notwithstanding any other provision, if specified, these rates will be adjusted as shown on Attachment 4.19-B, Supplement 1 section of the State Plan. Early and Periodic Screening, Diagnosis and Treatment (EPSDT) identifies treatments that are medically necessary to correct or ameliorate a defect, physical or mental illness or a condition that is identified.

Services contained in 1905(a) and not listed as covered services in the state agency manuals/state plan will be provided. Services provided as described in Section 1905(a) to correct or ameliorate defects and physical and mental illnesses and conditions discovered by screening services and not covered in the state plan will be provided if determined to be medically necessary by the appropriate agency staff or consultants.

The rate for services contained in 1905 (a) will be reimbursed at 80% of Medicare's fee. If no Medicare rate exists, the State will reimburse a rate equal to similar services in the state plan. If no similar service exists, the State will review the rates of surrounding Medicaid states. If the surrounding Medicaid State's fees are not available, the State will reimburse 80% of usual and customary charges or negotiate the fee with the provider.

EPSDT services provided by Local Health Departments (governmental agencies) may be cost settled as described in Attachment 4.19-B, Section 9, page 1 of the state plan.

MEDICAL ASSISTANCE  
State: NORTH CAROLINA

PAYMENTS FOR MEDICAL AND REMEDIAL CARE AND SERVICE

---

Additional service categories are reimbursed as follows:

Hearing aids and hearing aid accessories are reimbursed at invoice cost (invoices must accompany claims for aids and accessories). Fitting and dispensing services are reimbursed at a fixed reasonable reimbursement fee.

Batteries are reimbursed at current retail costs; an invoice is not required and a dispensing fee is not allowed.

---

TN. No. 10-008  
Supersedes  
TN. No. 91-47

Approval Date 05-16-11

Eff. Date 07/01/2010

MEDICAL ASSISTANCE  
State: NORTH CAROLINA

PAYMENTS FOR MEDICAL AND REMEDIAL CARE AND SERVICE

---

4.c. Family Planning Services

Payments for Family Planning services covered under Attachment 3.1-A.1 are equal to the lower of the submitted charge or the appropriate fee from the North Carolina Medicaid Family Planning Services Fee Schedule. All rates are published on the website at <http://www.ncdhhs.gov/dma/fee/index.htm>. Except as otherwise noted in the plan, state-developed fee schedule rates are the same for both governmental and private providers. The agency's fee schedule rates were set as of July 1, 2013 and are effective for services provided on or after that date.

(a) Family Planning services are reimbursed at 100 percent of the Medicaid Physician Schedule in effect on July 1, 2013.

(b) Family Planning services provided by Local Health Departments (governmental agencies) are paid at cost and will be cost settled as described in Attachment 4.19-B, Section 9, page 1 of the state plan.

State Plan Under Title XIX of the Social Security Act  
Medical Assistance Program  
State: North Carolina

---

PHYSICIAN'S FEE SCHEDULE

(a) Except as otherwise noted in the plan, state-developed fee schedule rates are the same for both governmental and private providers of Physician Services. The agency's fee schedule rates were set as of July 1, 2011 and are effective for services provided on or after that date. All rates are published on the agency's website at <http://www.ncdhhs.gov/dma/fee/fee>.

(b) Physicians' services whether furnished in the office, the patient's home, a hospital, a nursing facility or elsewhere, shall be reimbursed based on the North Carolina Medicaid Fee Schedule which is based on 86 percent of the Medicare Fee Schedule Resource Based Relative Value System (RBRVS) in effect January 1 of each year, but with the following clarifications and modifications:

- (1) A maximum fee is established for each service and is applicable to all specialties and settings in which the service is rendered. Payment is equal to the lower of the maximum fee or the provider's customary charge to the general public for the particular service rendered.
- (2) Rates for services deemed to be associated with adequacy of access to health care services may be adjusted based on administrative review. The service must be essential to the health needs of the Medicaid recipients, no other comparable treatment available and a rate adjustment must be necessary to maintain physician participation within the geographic area at a level adequate to meet the needs of Medicaid recipients and for which no other provider is available.
- (3) Fees for new services are established based on this Rule, utilizing the most current RBRVS, if applicable. If there is no relative value unit (RVU) available from Medicare, fees shall be established based on the fees for similar services. If there is no RVU or similar service, the fee shall be set at 75 percent of the provider's customary charge to the general public. For codes not covered by Medicare that Medicaid covers, annual changes in the Medicaid payments shall be applied each January 1 and fee increases shall be applied based on the forecasted Gross National Product (GNP) Implicit Price Deflator. Said annual changes in the Medicaid payments shall not exceed the percentage increase granted by the North Carolina General Assembly.
- (4) Notwithstanding any other provision, if specified, these rates will be adjusted as shown on Attachment 4.19-B, Supplement 3, Page 1 of the State Plan.

(c) Administration of Vaccinations whether furnished in the office, the patient's home, a hospital, a nursing facility or elsewhere, shall be reimbursed based on the North Carolina Medicaid Fee Schedule. The fee for the Administration of Vaccinations is based on the CMS regional maximum, not to exceed the Medicare established cap.

Administration of Vaccinations is not subject to cost settlement when reimbursement on the North Carolina Medicaid Fee Schedule is equal to the CMS regional maximum cap.



State Plan Under Title XIX of the Social Security Act  
Medical Assistance Program  
State: North Carolina

---

Increased Primary Care Service Payment 42 CFR 447.405, 447.410, 447.415

Primary Care Services as defined in section 1902 whether furnished in the office, the patient's home, a hospital, a nursing facility or elsewhere, shall be reimbursed based on the North Carolina Affordable Care Act (ACA) Medicaid Fee Schedule.

Enhanced Affordable Care Act (ACA) Payments for Primary Care Services as defined in section 1902 with dates of service effective January 1, 2013 – December 31, 2014 will be reimbursed at no less than the Medicare Cost Share rates in effect January 1, 2013 – December 31, 2014 or, if greater, the Medicare Fee Schedule Resource Based Relative Value System (RBRVS) in effect as of July 1, 2009.

In accordance with 42 CFR 447.405(2)(b) for vaccines provided under the Vaccines for Children Program (VFC) in CYs 2013 and 2014, reimbursement must be the lesser of:

- (1) The Regional Maximum Administration Fee; or,
- (2) The Medicare fee schedule rate in CY 2013 or 2014

If no Medicare rate exists for a particular billing code, reimbursement shall be based on the January 2013 Medicare Fee Schedule Resource Based Relative Value System (RBRVS) and the 2009 conversion factor.

The ACA Primary Care Services fee schedule rates were set as of January 1, 2013 and are effective for services provided on or after that date and ending on December 31, 2014. The fee schedule is published on the agency's website at <http://www.ncdhhs.gov/dma/fee/fee.htm>.

Enhanced ACA Primary Care payments shall be made to eligible Primary Care Physicians with a specialty designation of family medicine, general internal medicine, or pediatric medicine or a subspecialty within those specialties recognized by the American Board of Medical Specialties (ABMS), the American Osteopathic Association (AOA), or the American Board of Physician Specialties (ABPS) who meets the following criteria:

- (1) Physicians must self-attest to a covered specialty or subspecialty designation.
- (2) ACA providers must specify that they either are Board certified in an eligible specialty or subspecialty and/or that 60 percent of their Medicaid claims for the prior year were for the E&M codes specified in the regulation.

State Plan Under Title XIX of the Social Security Act  
Medical Assistance Program  
State: North Carolina

---

Increased Primary Care Service Payment 42 CFR 447.405, 447.410, 447.415

(3) If attesting to Board Certification, the certification must remain valid for the entire time these supplemental payments are received by the physician.

(4) Physician Assistants and Nurse Practitioners must identify their supervising physician who qualifies for the enhanced payment.

(5) Payments will begin on or after January 1, 2013, but not prior to physician, physician assistant, or nurse practitioner's attestation. EXCEPTION: Physicians who attest on or before June 30, 2014 will be eligible for payments retroactive to the later of January 1, 2013, or the date upon which they met all requirements for higher payment under the Federal regulations

Primary Care physicians enrolling in calendar year 2013 or 2014 without board certification with attestation will require verification of 60% billed and paid primary care services as defined in section 1902 for the prior month of calendar year 2012.

ACA physician's billing history will be reviewed at the end of 2013 and 2014 to confirm that 60 percent of codes billed and paid during CY 2013 and 2014 were primary care services eligible for payment under sections 1902(a)(13)(C) and 1902(jj) of the Act.

Federally Qualified Health Centers, Rural Health Centers, School Based Health Centers, Health Departments and CABHA providers are not eligible for enhanced primary care services payments.

There shall be no cost settlement for any Primary Care Services provider in any setting for these services reimbursed at the enhanced ACA rates.

These payments will terminate on December 31, 2014.

**Reimbursement Template -Physician Services**

**Increased Primary Care Service Payment 42 CFR 447.405, 447.410, 447.415**

**Attachment 4.19-B: Physician Services 42 CFR 447.405 Amount of Minimum Payment**

The state reimburses for services provided by physicians meeting the requirements of 42 CFR 447.400(a) at the Medicare Part B fee schedule rate using the Medicare physician fee schedule rate in effect in calendar years 2013 and 2014 or, if greater, the payment rates that would be applicable in those years using the calendar year 2009 Medicare physician fee schedule conversion factor. If there is no applicable rate established by Medicare, the state uses the rate specified in a fee schedule established and announced by CMS.

- The rates reflect all Medicare site of service and locality adjustments.
- The rates do not reflect site of service adjustments, but reimburse at the Medicare rate applicable to the office setting.
- The rates reflect all Medicare geographic/locality adjustments.
- The rates are statewide and reflect the mean value over all counties for each of the specified evaluation and management and vaccine billing codes.

The following formula was used to determine the mean rate over all counties for each code: \_\_\_\_\_

**Method of Payment**

- The state has adjusted its fee schedule to make payment at the higher rate for each E&M and vaccine administration code.
- The state reimburses a supplemental amount equal to the difference between the Medicaid rate in effect on July 1, 2009 and the minimum payment required at 42 CFR 447.405.

Supplemental payment is made:  monthly  quarterly

The state's rates were set using a state developed fee schedule based on the January 2013 release in conjunction with the 2009 conversion factor.

The state will adjust the fee schedule to account for any changes in Medicare rates throughout the year.

**Primary Care Services Affected by this Payment Methodology**

- This payment applies to all Evaluation and Management (E&M) billing codes 99201 through 99499.
- The State did not make payment as of July 1, 2009 for the following codes and will not make payment for those codes under this SPA (specify codes). 99339, 99340, 99363, 99364, 99366, 99368, 99441, 99442, 99443, 99444, 99485, 99486, 99487, 99488, 99489, 99495, and 99496.
- The state will make payment under this SPA for the following codes which have been added to the fee schedule since July 1, 2009 (specify code and date added). 99224, 99225, and 99226 – effective January 1, 2011.

**Physician Services – Vaccine Administration**

For calendar years (CYs) 2013 and 2014, the state reimburses vaccine administration services furnished by physicians meeting the requirements of 42 CFR 447.400(a) at the lesser of the state regional maximum administration fee set by the Vaccines for Children (VFC) program or the Medicare rate in effect in CYs 2013 and 2014 or, if higher, the rate using the CY 2009 conversion factor.

- Medicare Physician Fee Schedule rate
- State regional maximum administration fee set by the Vaccines for Children program
- Rate using the CY 2009 conversion factor

**Documentation of Vaccine Administration Rates in Effect 7/1/09**

The state uses one of the following methodologies to impute the payment rate in effect at 7/1/09 for code 90460, which was introduced in 2011 as a successor billing code for billing codes 90465 and 90471.

- The imputed rate in effect at 7/1/09 for code 90460 equals the rate in effect at 7/1/09 for billing codes 90465 and 90471 times their respective claims volume for a 12 month period which encompasses July 1, 2009. Using this methodology, the imputed rate in effect for code 90460 at 7/1/09 is:\_\_\_\_\_.
- A single rate was in effect on 7/1/09 for all vaccine administration services, regardless of billing code. This 2009 rate is: \_\_\_\_\_.

**Documentation of Vaccine Administration Rates in Effect 7/1/09 (continued)**

Alternative methodology to calculate the vaccine administration rate in effect 7/1/09: \_\_\_\_\_

Note: This section contains a description of the state's methodology and specifies the affected billing codes. The State did not make payment as of July 1, 2011 for code 90460 and will not make payment for code 90460 under this SPA

**Effective Date of Payment**

E & M Services

This reimbursement methodology applies to services delivered on and after January 1, 2013, ending on but not prior to December 31, 2014. All rates are published at <http://www.ncdhhs.gov/dma/fee/fee.htm>.

Vaccine Administration

This reimbursement methodology applies to services delivered on and after January 1, 2013, ending on but not prior to December 31, 2014. All rates are published at <http://www.ncdhhs.gov/dma/fee/fee.htm>.

---

TN. No. 13-001  
Supersedes  
TN. No. NEW

Approval Date: 06-12-13

Eff. Date: 01/01/13

**PRA Disclosure Statement**

According to the Paperwork Reduction Act of 1995, no persons are required to respond to a collection of information unless it displays a valid OMB control number. The valid OMB control number for this information collection is 0938-1148. The time required to complete this information collection is estimated to average 48 hours per response, including the time to review instructions, search existing data resources, gather the data needed, and complete and review the information collection. If you have comments concerning the accuracy of the time estimate(s) or suggestions for improving this form, please write to :CMS, 7500 Security Boulevard, Attn: PRA Reports Clearance Officer, Mail Stop C4-26-05, Baltimore, Maryland 21244-1850.

State Plan Under Title XIX of the Social Security Act  
Medical Assistance  
State: NORTH CAROLINA

PAYMENTS FOR MEDICAL AND REMEDIAL CARE AND SERVICES

---

Physician Assistant Services:

Payments for Physician Assistant Services covered under Attachment 3.1-A.1 are equal to the lower of the submitted charge or the appropriate fee from the North Carolina Medicaid Physician Assistant Services Fee Schedule. The agency's rates were set as of April 1, 2012 and are effective on or after that date. All rates are published on the website at <http://www.ncdhhs.gov/dma/fee/index.htm>. Except as otherwise noted in the plan, State developed fee schedule rates are the same for both governmental and private providers.

(a) Physician Assistant Services are reimbursed at 100 percent of the Medicaid Physician Assistant Services Fee Schedule in effect.

(b) Notwithstanding any other provision, if specified, these rates will be adjusted as shown on Attachment 4.19B, Supplement 3, Page 1k of the State Plan.

MEDICAL ASSISTANCE  
State: NORTH CAROLINA  
PAYMENTS FOR MEDICAL AND REMEDIAL CARE AND SERVICES

---

(c) Supplemental Payments

- (1) Supplemental payments will be made to Eligible Medical Professional Providers. These supplemental payments will equal the difference between the Medicaid payments otherwise made under this state plan and the Average Commercial Rate Payment. These supplemental payments will, for the same dates of service, be reduced by any other supplemental payments for professional services found elsewhere in the state plan.
- (2) Eligible Medical Professional Providers must meet all of the following requirements. An Eligible Medical Professional Providers must be:

(i) Physicians paid under this Section 5, and other professionals paid under Section 6a-d or Section 17 of this Attachment; and

(ii) Licensed in the State of North Carolina and eligible to enroll in the North Carolina Medicaid program as a service provider; and

(iii) Employed by, contracted to provide a substantial amount of teaching services, or locum tenens of the state-operated school of medicine (SOM) at East Carolina University or the University of North Carolina at Chapel Hill, or employed or locum tenens within the University of North Carolina Health Care System. A professional "contracted to provide a substantial amount of teaching services" is a professional where all or substantially all of the clinical services provided to patients by that contracted professional involves supervision and/or teaching of medical students, residents, or fellows.

Except for professional providers in a Hospital-Based Group Practice, Eligible Medical Professional Providers shall exclude any professional provider that is a member of a group practice acquired or assimilated by the UNC HCS after July 1, 2010. A Hospital-Based Group Practice includes professional providers with the following hospital-based specialties: anesthesiology, radiology, pathology, neonatology, emergency medicine, hospitalists, radiation-oncology, and intensivists.

For a group practice that does not consist of professional providers employed by the SOM, is not a Hospital-Based Group Practice, and was included within the UNC HCS on or before July 1, 2010, the number of Eligible Medical Professional Providers in the group practice may not increase beyond the number of Eligible Medical Professional Providers in the group practice as of July 1, 2010.

- (3) Supplemental payments will be made quarterly and will not be made prior to the delivery of services.

- (4) The Quarterly Average Commercial Rate to be paid will be determined in accordance with the following calculation.

(i) Compute Average Commercial Fee Schedule: Compute the average commercial allowed amount per procedure code for the top five payers with payment rates. The top five commercial third party payers will be determined by total billed charges. If there are any differences in payment on a per billing code basis for services rendered by different types of medical professionals, the Department will calculate separate Average Commercial Fee Schedules to reflect these differences. The data used to develop the Average Commercial Fee Schedule(s) will be based upon payments from the most recently completed state fiscal year. The Average Commercial Fee Schedules will be computed at least once per fiscal year.

MEDICAL ASSISTANCE  
State: NORTH CAROLINA

PAYMENTS FOR MEDICAL AND REMEDIAL CARE AND SERVICES

---

(ii) Calculate the Quarterly Average Commercial Payment Ceiling: For each quarter of the current fiscal year, multiply the Average Commercial Fee Schedule amount, as determined in Paragraph (c)(4)(i) above, by the number of times each procedure code was rendered and paid in the quarter to the Eligible Medical Professional Providers on behalf of Medicaid beneficiaries as reported by the MMIS. If applicable, a separate payment ceiling will be set when payment for the same service differs according to the type of professional rendering the service. The sum of the product for all procedure codes will determine the Quarterly Average Commercial Payment Ceiling.

(5) Supplemental Payments to be paid will be determined in accordance with the following calculation:

(i) Determine the Quarterly Supplemental Payment Ceiling at the Average Commercial Rate using the following formula:

(Quarterly Average Commercial Payment per CPT Code) as calculated x (Medicaid Volume per CPT Code)  
= Quarterly Supplemental Payment Ceiling at the Average Commercial Rate calculated as outlined in section (4) paragraph (i).

(ii) Supplemental Payments will equal the Quarterly Supplemental Payment Ceiling at the Average Commercial Rate less the total Medicaid payments made for the quarter to Eligible Medical Professional Providers for the procedure codes included in the calculation of the Average Commercial Fee Schedule in paragraph (4)(i) above, as reported from the MMIS. Medicaid volume and payments shall include all available payments and adjustments.



PAYMENTS FOR MEDICAL AND REMEDIAL CARE AND SERVICE

---

Enhanced Payments for Pregnancy Medical Home Services

This service will be provided by a Pregnancy Medical Home provider (PMH) (as specified in Attachment 3.1-B, Page 7(a) and Attachment 3.1-F) enrolled in Medicaid who may be either private or governmental.

Except as otherwise noted in the plan, state-developed fee schedule rates are the same for both governmental and private PMH providers. The PMH fee schedule rates were set as of March 1, 2011 and are effective for services provided on or after that date. The fee schedule is published on the agency's website at <http://www.ncdhhs.gov/dma/fee/fee.htm>.

Two enhanced payments may be made to the PMH providers. Upon completion of the high risk screening, an enhanced payment of \$50.00 will be made to the PMH. Upon completion of the recipient's post partum visit, an enhanced payment of \$150.00 will be made to the PMH provider. The PMH providers will receive a maximum of \$200 enhanced payments per recipient per pregnancy even if there are multiple births.

PMH providers receive an enhanced rate for a vaginal delivery by paying the same rate for the vaginal delivery as for an uncomplicated c-section. Only the physician rates for ante partum codes, delivery codes and post partum codes are enhanced. The enhanced rates were determined by applying a 13.2% increase to the NC Medicaid Physician Fee Schedule rate as established in Attachment 4.19-B Section 5, Page 1 of the State Plan.

There shall be no cost settlement for any provider in any setting for these services reimbursed at the enhanced rates.

Notwithstanding any other provision, if specified, these rates will be adjusted as shown on Attachment 4.19-B, Supplement 3, Page 1 of the State Plan.

State Plan Under Title XIX of the Social Security Act  
Medical Assistance  
State: NORTH CAROLINA

PAYMENTS FOR MEDICAL AND REMEDIAL CARE AND SERVICES

---

6. Medical care and any other type of remedial care recognized under State law, furnished by licensed practitioners within the scope of their practice as defined by State law:

Chiropractic Services, Podiatry Services, Optometry Services, Nurse Practitioner Services, Independent Practitioner Services and Other Licensed Practitioner Services.

a. **Podiatry Services:**

Payments for Podiatry Services covered under Attachment 3.1-A.1 are equal to the lower of the submitted charge or the appropriate fee from the North Carolina Medicaid Podiatry Services Fee Schedule. The agency's rates were set as of November 1, 2011 and are effective on or after that date. All rates are published on the website at <http://www.ncdhhs.gov/dma/fee/index.htm>. Except as otherwise noted in the plan, State developed fee schedule rates are the same for both governmental and private providers.

(a). Effective November 1, 2011 Podiatry Services rates shall be set at 97.33% percent of North Carolinas' Medicaid Physician Services Fee Schedule in effect on October 1 of 2009. Effective July 1, 2012 Podiatry Services rates shall be set at 98% percent of North Carolinas' Medicaid Physician Services Fee Schedule in effect on October 1 of 2009.

(b) Notwithstanding any other provision, if specified, these rates will be adjusted as shown on Attachment 4.19B, Supplement 3, Page 1e of the State Plan.

State Plan Under Title XIX of the Social Security Act  
Medical Assistance  
State: NORTH CAROLINA

PAYMENTS FOR MEDICAL AND REMEDIAL CARE AND SERVICES

---

Medical care and any other type of remedial care recognized under State law, furnished by licensed practitioners within the scope of their practice as defined by State law:

Chiropractic Services, Podiatry Services, Optometry Services, Nurse Practitioner Services, Independent Practitioner Services and Other Licensed Practitioner Services.

**b. Optometry Services:**

Payments for Optometry Services covered under Attachment 3.1-A.1 are equal to the lower of the submitted charge or the appropriate fee from the North Carolina Medicaid Optometry Services Fee Schedule. The agency's rates were set as of November 1, 2011 and are effective on or after that date. All rates are published on the website at <http://www.ncdhhs.gov/dma/fee/index.htm>. Except as otherwise noted in the plan, State developed fee schedule rates are the same for both governmental and private providers.

(a) Effective November 1, 2011 Optometry Services shall be set at 97.36 % percent of North Carolinas' Medicaid Physician Services Fee Schedule in effect on October 1 of 2009. Effective July 1, 2012 Optometry Services rates shall be set at 98.% percent of North Carolinas' Medicaid Physician Services Fee Schedule in effect on October 1 of 2009

(b) Notwithstanding any other provision, if specified, these rates will be adjusted as shown on Attachment 4.19B, Supplement 3, Page 1f of the State Plan.

State Plan Under Title XIX of the Social Security Act  
Medical Assistance  
State: NORTH CAROLINA

PAYMENTS FOR MEDICAL AND REMEDIAL CARE AND SERVICES

---

Medical care and any other type of remedial care recognized under State law, furnished by licensed practitioners within the scope of their practice as defined by State law:

Chiropractic Services, Podiatry Services, Optometry Services, Nurse Practitioner Services, Independent Practitioner Services and Other Licensed Practitioner Services.

c. **Chiropractic Services:**

Payments for Chiropractic Services covered under Attachment 3.1-A.1 are equal to the lower of the submitted charge or the appropriate fee from the North Carolina Medicaid Chiropractic Services Fee Schedule. The agency's rates were set as of November 1, 2011 and are effective on or after that date. All rates are published on the website at <http://www.ncdhhs.gov/dma/fee/index.htm>. Except as otherwise noted in the plan, State developed fee schedule rates are the same for both governmental and private providers.

(a) Effective November 1, 2011 Chiropractic Services shall be set at 97.33% percent of North Carolinas' Medicaid Physician Services Fee Schedule in effect on October 1 of 2009. Effective July 1, 2012 Chiropractic Services rates shall be set at 98.% percent of North Carolinas' Medicaid Physician Services Fee Schedule in effect on October 1 of 2009

(b) Notwithstanding any other provision, if specified, these rates will be adjusted as shown on Attachment 4.19B, Supplement 3, Page 1d of the State Plan.

State Plan Under Title XIX of the Social Security Act  
Medical Assistance  
State: NORTH CAROLINA

PAYMENTS FOR MEDICAL AND REMEDIAL CARE AND SERVICES

---

Medical care and any other type of remedial care recognized under State law, furnished by licensed practitioners within the scope of their practice as defined by State law:

Chiropractic Services, Podiatry Services, Optometry Services, Nurse Practitioner Services, Independent Practitioner Services and Other Licensed Practitioner Services.

**d. Nurse Practitioner Services:**

(1) Payments for Nurse Practitioner Services covered under Attachment 3.1-A.1 are equal to the lower of the submitted charge or the appropriate fee from the North Carolina Medicaid Nurse Practitioner Services Fee Schedule. The agency's rates were set as of November 1, 2011 and are effective on or after that date. All rates are published on the website at <http://www.ncdhhs.gov/dma/fee/index.htm>. Except as otherwise noted in the plan, State developed fee schedule rates are the same for both governmental and private providers.

(a) Effective November 1, 2011 Nurse Practitioner Services shall be set at 100 % percent of North Carolinas' Medicaid Physician Services Fee Schedule in effect on November 1, 2011.

(b) Notwithstanding any other provision, if specified, these rates will be adjusted as shown on Attachment 4.19B, Supplement 3, Page 1g of the State Plan.

(2) Enhanced Payments for Pregnancy Medical Home Services will be made to licensed nurse practitioners for services provided by a Pregnancy Medical Home provider as specified in Attachment 3.1-B, Page 7(a) and Attachment 3.1-F. Reimbursement will be as described in Attachment 4.19-B Section 5, Page 4 of the State Plan. There shall be no cost settlement for any provider in any setting for these services reimbursed at the enhanced rates

State Plan Under Title XIX of the Social Security Act  
Medical Assistance  
State: NORTH CAROLINA

PAYMENTS FOR MEDICAL AND REMEDIAL CARE AND SERVICES

---

Medical care and any other type of remedial care recognized under State law, furnished by licensed practitioners within the scope of their practice as defined by State law:

Chiropractic Services, Podiatry Services, Optometry Services, Nurse Practitioner Services, Independent Practitioner Services and Other Licensed Practitioner Services.

e. Independent Practitioner Services(IPS): Physical, Occupational, Speech, Language Pathology/Audiology, and Respiratory Therapy.

Payments for Independent Practitioner Services covered under Attachment 3.1-A.1, are equal to the lower of the submitted charge or the appropriate fee from the specific Independent Practitioner Services Fee Schedule. The agency's rates were set as of November 1, 2011 and are effective on or after that date. All rates are published on the website at <http://www.ncdhhs.gov/dma/fee/index.htm>. Except as otherwise noted in the plan, State developed fee schedule rates are the same for both governmental and private providers.

(a) Effective November 1, 2011 Independent Practitioner Services shall be set at 97.34 % percent of North Carolinas' Medicaid Physician Services Fee Schedule in effect on October 1 of 2009. Effective July 1, 2012 Independent Practitioner Services rates shall set at 98% percent of North Carolinas' Medicaid Physician Services Fee Schedule in effect on October 1 of 2009.

(b) Notwithstanding any other provision, if specified, these rates will be adjusted as shown on Attachment 4.19B, Supplement 3, Page 1h of the State Plan.

State Plan Under Title XIX of the Social Security Act  
Medical Assistance  
State: NORTH CAROLINA

PAYMENTS FOR MEDICAL AND REMEDIAL CARE AND SERVICES

---

Medical care and any other type of remedial care recognized under State law, furnished by licensed practitioners within the scope of their practice as defined by State law: Chiropractic Services, Podiatry Services, Optometry Services, Nurse Practitioner Services, Independent Practitioner Services and Other Licensed Practitioner Services.

f. Other Licensed Practitioner Services:

(1) CPT code rates for these licensed practitioners are adjusted annually in accordance with the physician services. A maximum fee is established for each service and is applicable to all specialties and setting in which the service is rendered. Payments for these Other Licensed Practitioner Services covered under Attachment 3.1-A.1, are equal to the lower of the submitted charge or the fee schedule rate.

The following licensed practitioners will have the following reductions to their maximum fee of the physician fee schedule rate.

- (a) Licensed Nurse Practitioners certified in child and adolescent psychiatry will receive 85%,
- (b) Licensed Clinical Social Workers will receive 75%,
- (c) Licensed Professional Counselors will receive 75%,
- (d) Licensed Marriage and Family Therapists will receive 75%,
- (e) Licensed Clinical Nurse Specialists certified in child and adolescent psychiatry will receive 85%,
- (f) Certified Psychological Associates will receive 75%,
- (g) Licensed Clinical Addictions Specialists and Certified Clinical Supervisors who are licensed as clinical addiction specialists will receive 75%,

Notwithstanding any other provision, if specified, the Other Licensed Practitioner Services rates will be adjusted as shown on Attachment 4.19B, Supplement 3, Page 1i of the State Plan.

(2) Any mental health non-CPT codes service which are available for other practitioners to bill will have its rate established based on Attachment 4.19-B, Section 13.

MEDICAL ASSISTANCE  
State: NORTH CAROLINA

PAYMENTS FOR MEDICAL AND REMEDIAL CARE AND SERVICES

---

---

- (4) Annual fee increases are applied each January 1 based on the physician fee schedule adjustments as set out in Attachment 4.19-B, Section 5, but not to exceed the percentage increase approved by the North Carolina State Legislature.
- (5) Fee for new services are established based on the fees for similar existing services. If there are no similar services the fee is established at 75% of estimated average charge.
- (6) Fees for particular services can be increased based on administrative review if it is determined that the service is essential to the health needs of Medicaid recipients, that no alternative treatment is available, and that a fee adjustment is necessary to maintain physician participation at a level adequate to meet the needs of Medicaid recipients. A fee may also be decreased based on administrative review if it is determined that the fee may exceed the Medicare allowable amount for the same or similar services, or if the fee is higher than Medicaid fees for similar services, or if the fee is too high in relation to the skills, time and other resources required to provide the particular service.
- (7) Medicaid Services Provided in Schools are services that are medically necessary and provided in schools to Medicaid recipients in accordance with an Individualized Education Program, (IEP) or an Individual Family Service Plan (IFSP). Covered services include the following as described in Attachment 3.1-A.1:
  - a. Audiology
  - b. Occupational Therapy
  - c. Physical Therapy
  - d. Psychological/Counseling Services
  - e. Speech
  - f. Nursing Services

---

TN No: 07-008  
Supersedes  
TN No: 04-011

Approval Date: 06/06/08

Effective Date: 07/18/07



MEDICAL ASSISTANCE  
State: NORTH CAROLINA

PAYMENTS FOR MEDICAL AND REMEDIAL CARE AND SERVICES

---

The interim payment to the Local Education Agencies for services (Paragraph 7a-e) listed above are based on the physician fee schedule methodology as outlined in Attachment 4.19-B, Section 5. These rates are adjusted July 1<sup>st</sup> of each year.

The interim payment for nursing services (Paragraph 7f) has 3 components, each established on a 15-minute unit fee. The interim rate for Attendant Care Services is equal to the current rate for Personal Care Services. The interim rate for RN Services and LPN Services are established by using the national average hourly salary for RNs and LPNs based on data from the U.S. Department of Labor. The fee per 15-minute unit is then derived from the average hourly salary for Registered Nurse (RN) and Licensed Practical Nurse (LPN).

- A. Direct Medical Services Payment Methodology  
Beginning, with cost reporting periods ending on or after June 30, 2008, the Division of Medical Assistance (DMA) will begin using a cost based methodology for all Local Education Agencies (LEAs). This methodology will consist of a cost report, time study and reconciliation. If payments exceed Medicaid-allowable costs, the excess will be recouped.

Once the first year's cost reports are received, and each subsequent year, the Division will examine the cost data for nursing services to determine if an interim rate change is justified. Notwithstanding any other provision, if specified, these rates will be adjusted as shown on Attachment 4.19-B, Supplement 1 section of the State Plan.

To determine the Medicaid-allowable direct and indirect costs of providing direct medical services to Medicaid-eligible clients in the LEA, the following steps are performed:

- (1) Direct costs for direct medical services include unallocated payroll costs and other unallocated costs that can be directly charged to direct medical services. Direct payroll costs include total compensation of direct services personnel listed in the descriptions of the covered Medicaid services delivered by school districts in Attachment 3.1-A.1.

---

TN No: 07-008  
Supersedes  
TN No: NEW

Approval Date: 06/06/08

Effective Date: 07/18/07

MEDICAL ASSISTANCE  
State: NORTH CAROLINA

PAYMENTS FOR MEDICAL AND REMEDIAL CARE AND SERVICES

---

Other direct costs include costs directly related to the approved direct services personnel for the delivery of medical services, such as purchased services, capital outlay, materials and supplies. These direct costs are accumulated on the annual cost report, resulting in total direct costs. The cost report contains the scope of cost and methods of cost allocation that have been approved by the Centers for Medicare & Medicaid Services (CMS).

- (2) Total direct costs for direct medical services from Item 1 above are reduced on the cost report by any federal grant payments with a matching requirement resulting in adjusted direct costs for direct medical services.
- (3) The net direct costs for each service is calculated by applying the direct medical services percentage from the CMS-approved time study to the adjusted direct costs from Item 2 above.

A time study which incorporates a CMS-approved methodology is used to determine the percentage of time medical service personnel spend on IEP-related medical services, and general and administrative time. This time study will assure that there is no duplicate claiming relative to claiming for administrative costs.

- (4) Indirect costs are determined by applying the school district's specific unrestricted indirect cost rate to its net direct costs. North Carolina public school districts use predetermined fixed rates for indirect costs. The Department of Public Instructions (DPI) is the cognizant agency for the school districts, and approves unrestricted indirect cost rates for school districts for the US Department of Education (USDE). Only Medicaid-allowable costs are certified by providers. Providers are not permitted to certify indirect costs that are outside their unrestricted indirect cost rate.
- (5) Net direct costs and indirect costs are combined.

---

TN No: 07-008  
Supersedes  
TN No: NEW

Approval Date: 06/06/08

Effective Date: 07/18/07

MEDICAL ASSISTANCE  
State: NORTH CAROLINA

PAYMENTS FOR MEDICAL AND REMEDIAL CARE AND SERVICES

---

- (6) Medicaid's portion of total net costs is calculated by multiplying the results from Item 5 by the ratio of the total number of students with Medicaid Individualized Education Program (IEP) or an Individual Family Service Plan (IFSP) receiving services to the total number of students with an IEP or an IFSP.

B. Certification of Funds Process

Cost reports must be prepared and completed by each LEA on a quarterly basis to reflect the time study results for the quarter in which costs were incurred. On an annual basis, each provider will certify through its cost report its total actual, incurred Medicaid allowable costs/expenditures, including the federal share and the nonfederal share. Providers are permitted only to certify Medicaid-allowable costs and are not permitted to certify any indirect costs that are outside their unrestricted indirect cost rate.

C. Annual Cost Report Process

For Medicaid services listed in Paragraph 7a-f provided in schools during the state fiscal year, each LEA provider must complete an annual cost report. The cost report is due on or before March 1 following the reporting period.

Providers that fail to fully and accurately complete Medicaid cost reports within the time period specified by the Division of Medical Assistance or that fail to furnish required documentation and disclosures for Medicaid cost reports required under this Plan within the time period specified by the Division, may be subject to penalties for non-compliance. A 20% withhold of Medicaid payments will be imposed upon the delinquent provider 30 days after the Medicaid cost report filing deadline unless the provider has made a written request for an extension of the Medicaid cost report filing due date to the Division of Medical Assistance and has received a written approval from the Division of Medical Assistance. The withholding of monies will continue until the Medicaid cost report filing requirements have been satisfied. Once, all requirements have been satisfied withheld monies will be released to the provider. Any monies withheld will not accrue interest to the benefit of the provider.

The primary purposes of the cost report are to:

- (1) Document the provider's total CMS-approved, Medicaid-allowable costs of delivering Medicaid coverable services using a CMS-approved cost allocation methodology

---

TN No: 07-008  
Supersedes  
TN No: NEW

Approval Date: 06/06/08

Effective Date: 07/18/07

MEDICAL ASSISTANCE  
State: NORTH CAROLINA

PAYMENTS FOR MEDICAL AND REMEDIAL CARE AND SERVICES

---

- (2) Reconcile annual interim payments to its total CMS-approved, Medicaid-allowable costs using a CMS approved cost allocation methodology.

The annual School Based Services (SBS) Cost Report includes a certification of funds statement to be completed, certifying the provider's actual, incurred costs/expenditures. All filed annual SBS Cost Reports are subject to desk review by Division of Medical Assistance or its designee.

D. The Cost Reconciliation Process

The cost reconciliation process must be completed within twenty-four months of the end of the reporting period covered by the annual School Based Services (SBS) Cost Report. The total CMS-approved, Medicaid-allowable scope of costs based on CMS-approved cost allocation methodology procedures are compared to the LEA provider's Medicaid interim payments delivered during the reporting period as documented in the Medicaid Management Information System (MMIS), resulting in a cost reconciliation.

For the purposes of cost reconciliation, the state may not modify the CMS-approved scope of costs, the CMS-approved cost allocation methodology procedures, or its CMS-approved time study for cost-reporting purposes. Any modification to the scope of cost, cost allocation methodology procedures, or time study for cost-reporting purposes requires approval from CMS prior to implementation; however, such approval does not necessarily require the submission of a new state plan amendment.

E. The Cost Settlement Process

EXAMPLE: For services delivered for the period covering July 1, 2007, through June 30, 2008, the annual SBS Cost Report is due on or before March 1, 2009, with the cost reconciliation and settlement processes completed no later than June 30, 2010.

If a provider's interim payments exceed the actual, certified costs for Medicaid services provided in schools to Medicaid clients, the provider will remit the federal share of the overpayment at the time the cost report is submitted. The Division of Medical Assistance will submit the federal share of the overpayment to CMS within 60 days of identification.

If the actual, certified costs of a LEA provider exceed the interim payments, the Division of Medical Assistance will pay the federal share of the difference to the provider in accordance with the final actual certification agreement and submit claims to CMS for reimbursement of that payment in the federal fiscal quarter following payment to the provider.

MEDICAL ASSISTANCE  
State: NORTH CAROLINA

PAYMENTS FOR MEDICAL AND REMEDIAL CARE AND SERVICE

---

---

7. HOME HEALTH SERVICES

Services provided by Medicare certified home health agencies participating in the North Carolina Medicaid Program are to be reimbursed on a prospective payment basis as set forth in this plan. Qualified providers of Durable Medical Equipment (and DME associated supplies) and Home Infusion Therapies are paid on the basis of reasonable charges as defined in Section 7B and C, respectively. The intent of this plan is to develop reasonable rates that provide incentives for the cost effective and efficient delivery of home health services.

A. REIMBURSEMENT METHODS FOR CERTIFIED HOME HEALTH AGENCIES

- (a) A maximum rate per visit is established annually for each of the following services:
- (1) Registered or Licensed Practical Nursing Visit;
  - (2) Physical Therapy Visit;
  - (3) Speech Therapy Visit;
  - (4) Occupational Therapy visit;
  - (5) Home Health Aide Visit.
- (b) The maximum rate for the services identified in Section (a) above are computed and applied as follows:
- (1) Payment of claims for visits is based on the lower of the billed customary charges or the maximum rate of the particular service.
  - (2) Maximum per visit rates effective July 1, 1996 for Registered or Licensed Practical Nursing, Physical Therapy, Speech Therapy, and Occupational Therapy shall be equal to the rates in effect on July 1, 1995.  
To compute the annual maximum rates effective each July 1 subsequent to July 1, 1996 through September 30, 2006, the maximum rates per visit are adjusted as described in Sections (4), (5), and (6).

MEDICAL ASSISTANCE  
State: NORTH CAROLINA

PAYMENTS FOR MEDICAL AND REMEDIAL CARE AND SERVICE

---

- (3) Maximum per visit rate effective July 1, 1996 for Home Health Aide shall be equal to the rate in effect on July 1, 1995.  
To compute the annual maximum rates effective each July 1 subsequent to July 1, 1996 through September 30, 2006, the fiftieth percentile cost per visit calculated from the base year 1994 cost reports is adjusted as described in Sections (4), (5), and (6).
- (4) Each year maximum rates are adjusted by an annual cost index factor. The cost index has a labor component with a relative weight of 75 percent and a non-labor component with a relative weight of 25 percent. The relative weights are derived from the Medicare Home Health Agency Input Price Index published in the Federal Register dated May 30, 1986. Labor cost changes are measured by the annual percentage change in the average hourly earnings of North Carolina service wages per worker. Non-labor cost changes are measured by the annual percentage change in the GNP Implicit Price Deflator.
- (5) The annual cost index equals the sum of the products of multiplying the forecasted labor cost percentage change by 75 percent and multiplying the forecasted non-labor cost percentage change by 25 percent. For services included under Section 2 the July 1, 1996 effective rates are multiplied by the cost index factor for each subsequent year up to the year in which the rates apply. For services included under Section 3 (i) base year costs per visit are multiplied by the cost index factor for each subsequent year up to the year in which rates apply.
- (6) Other adjustments may be necessary for home health services to comply with federal or state laws or rules.
- (c) Medical supplies and equipment covered under Home Health (HH) services are reimbursed at the lower of billed customary charges or the comparable Durable Medical Equipment (DME) maximum allowable amount in effect as of August 1 of each year. If a new item is not covered by the DME program and a Medicare allowable is available, the rate will be set at the Medicare allowable amount available to the Division of Medical Assistance as of July 1 of that year. If a Medicare allowable amount cannot be obtained for a particular item, the rate will be established based on average estimate of reasonable cost. Rates will be updated each September 1 based on the forecast of the Gross National Product Implicit Price Deflator.

Rates for medical supplies deemed to be associated with adequacy of access to health care services are reviewed annually in relation to Medicare rates and according to the normal rate review procedure. This administrative review entails the performance of a cost review of providers' invoices, averaging the providers' costs and setting the rate at that average amount. The service must be essential to the health needs of the Medicaid recipients, no other comparable treatment available, and a rate adjustment must be necessary to maintain provider participation at a level adequate to meet the needs of Medicaid recipients.

MEDICAL ASSISTANCE  
State: NORTH CAROLINA

PAYMENTS FOR MEDICAL AND REMEDIAL CARE AND SERVICE

---

- (d) After October 1, 2006, annual rate adjustments will be effective each year on September 1. Medical supplies and equipment covered under Home Health (HH) services are reimbursed at the lower of billed customary charges or the comparable Durable Medical Equipment (DME) maximum allowable amount in effect as of August 1 of each year. Notwithstanding any other provision, if specified these rates will be adjusted as shown on Supplement 1 to the Attachment 4.19-B section of the state plan.

Rates for supplies and equipment shall be consistent among the HIT, Home Health (HH), and DME programs. If a rate appeal results in a change in the rate for one of the three programs, it will also become effective for the other two programs.

If, as of October 1, 2006, a rate for an individual supply or equipment usage/purchase is different in either HH or HIT from the DME rate, the DME rate will be used unless the DME rate is the lower rate. In that case, no rate increases will be applied to the item in either HIT or HH until the DME rate is equal or greater than the rate of HH or HIT in effect on October 1, 2006. Once the DME rate for the item exceeds the existing rate for HIT or HH, those programs will adopt the DME rate.

There will be no retroactive payment adjustments for fee changes.

Public and private providers are reimbursed at the same rate, as published on the fee schedule located at <http://www.dhhs.state.nc.us/dma/fee/fee.htm#other>.

MEDICAL ASSISTANCE  
State: NORTH CAROLINA

PAYMENTS FOR MEDICAL AND REMEDIAL CARE AND SERVICE

---

---

APPEALS

Providers may appeal maximum rates by presenting written requests and supporting data. Rates will not be adjusted retroactively. Appeals will be processed in accordance with Division procedures for Provider Reimbursement Reviews.

COST REPORTING AND AUDITING

Annual cost reporting is required in accordance with the Medicare principles of reimbursement.

PAYMENT ASSURANCES

(a) The State will pay the amounts determined under this plan for each covered service furnished in accordance with the requirements of the State Medicaid Plan, provider participation agreement, and Medicaid policies and procedures. The payments made under this methodology will not exceed the upper limits as established by 42 C.F.R. 447.325.

---

TN. No. 90-04  
Supersedes  
TN. No. 88-12

Approval Date May 2 1990

Eff. Date 5/1/90



MEDICAL ASSISTANCE  
STATE: NORTH CAROLINA

PAYMENTS FOR MEDICAL AND REMEDIAL CARE AND SERVICE

=====

(b) Participation in the program is limited to providers who accept, as payment in full, the amounts paid in accordance with this plan.

(c) In all circumstances involving third party payment, Medicaid is the payor of last resort. Any amounts paid by non-Medicaid sources are deducted in determining Medicaid payment. For patients with both Medicare and Medicaid coverage, Medicaid payment is limited to the amount of Medicare-related deductibles and/or coinsurance for services, supplies and equipment covered under the Medicare program.

(d) Excess payments may be recouped from any provider found to be billing amounts in excess of its customary charges, or costs if charges are nominal.

B. DURABLE MEDICAL EQUIPMENT

Eff. 8/1/91

(a) Payment for each claim for durable medical equipment and associated supplies shall be equal to the lower of the supplier's usual and customary billed charges or the maximum fee established for each item of durable medical equipment or related supply. The maximum fees are set at the Medicaid fee schedule in effect on July 1, 1991. Fees for added equipment shall be at Medicare Part B Fees. If a Medicare fee can not be obtained for added equipment, then the fee shall be based on an estimate of reasonable cost. The maximum allowable fee shall be updated each August 1 based on the Gross National Product (GNP) implicit price deflator. Notwithstanding any other provision, if specified these rates will be adjusted as shown on Attachment 4.19-B, Supplement 2, Page 1 of the state plan. [The maximum allowable fee may be adjusted for any changes resulting from market and cost analysis conducted by the Division of Medical Assistance.] There shall be no retroactive payment adjustments for fee changes.

(b) Each equipment item shall be assigned to one of the following categories of payment methods:

(1) Purchase fee paid for inexpensive, routinely purchased, and customized equipment, and DME Supplies.

MEDICAL ASSISTANCE

State: North Carolina

PAYMENT FOR MEDICAL AND REMEDIAL CARE AND SERVICE

---

- (2) Monthly rental paid up to purchase price but for no more than 15 continuous months. Monthly rental is paid for other types of equipment when the initial expected medical needs is less than six (6) months, but not to exceed the purchase price if need extends beyond six months. Equipment with an initial expected medical need of six months or more may be paid as a purchase or a rental.
- (3) Monthly rental payment for oxygen and oxygen equipment without any limitations.
- (4) Servicing and repair fees shall be established for appropriate items. Through a prior approval process, recipient owned equipment is repaired on an "as needed basis if the repair estimate is less than the cost of replacement and if the equipment has not gone beyond its established life expectancy. Service contracts are not covered and manufacturer's warranties are expected to be honored when appropriate. Rental equipment repairs are not reimbursed separately but are considered to be covered in the monthly rental fee.

MEDICAL ASSISTANCE  
State: NORTH CAROLINA

PAYMENTS FOR MEDICAL AND REMEDIAL CARE AND SERVICE

=====

The percentage increase approved by the North Carolina Legislature is developed by the Division of Medical Assistance and presented to the Legislature. It is an estimate of reasonable increases in our area and is calculated using the Gross National Product Implicit Price Deflator and local forecasts of medical equipment costs from the State Budget Office.

Equipment with an initial expected medical need of six months or more may be paid as purchase or rental clarification: When the need is projected at six months or more, the equipment may be purchased initially, or it may be rented until the purchased price is met, at which time it is considered purchased.

Estimates of reasonable costs are determined thru the use of a current ratio of fees to charge data established from paid claims files. This ratio is applied to average current charges as received from local providers.

MEDICAL ASSISTANCE  
State: NORTH CAROLINA

PAYMENTS FOR MEDICAL AND REMEDIAL CARE AND SERVICE

---

C. HOME INFUSION THERAPY- (HIT)

In-home parental and enteral therapy supplies are reimbursed at the lower of billed customary charges or the comparable Durable Medical Equipment (DME) maximum allowable amount in effect as of August 1 of each year. Rates for added supplies shall be at Medicare Part B fees if no DME rate exists. If comparable Medicare fees are not available, fees will be based on average charges and updated each September 1 based on the forecast of the Gross National Product Implicit Price Deflator. Notwithstanding any other provision, if specified these rates will be adjusted as shown on Attachment 4.19-B, Supplement 1, Page 2 of the state plan.

---

TN. No.: 06-011  
Supersedes  
TN. No.: 02-18

Approval Date: 12/22/06

Effective Date: 09/01/06

MEDICAL ASSISTANCE  
State: NORTH CAROLINA

PAYMENTS FOR MEDICAL AND REMEDIAL CARE AND SERVICE

---

I. Antibiotic, Chemotherapy and Pain Management

Four separate fee schedule amounts are calculated; one for pain management, one for chemotherapy, one for tocolytic therapy, and one for antibiotics and other drug therapies. The per diem for each type of drug therapy except tocolytic therapy is the sum of the per diem allowances for each of five service components. The per diem calculations for the components are computed as follows:

- 1) Pharmacy Services: the per diem allowance for pharmacy services for each type of drug therapy is calculated using national average hourly salaries and benefits for pharmacists multiplied by the estimated average hours per day spent in preparation and compounding of each drug, checking the drug interactions, and other pharmacy services (all averages are derived using actuarial calculations).
- 2) Pharmacy Supplies: the per diem allowance for pharmacy supplies for each type of drug therapy is calculated for each drug using national average prices for supplies associated with the preparation, compounding, and infusion delivery system of a single dose of each IV therapy multiplied by the average number of doses per day (all averages are derived using actuarial calculations).

---

TN. No.: 06-011  
Supersedes  
TN. No.: 91-53

Approval Date: 12/22/06

Effective Date: 09/01/06

MEDICAL ASSISTANCE  
State: NORTH CAROLINA

PAYMENTS FOR MEDICAL AND REMEDIAL CARE AND SERVICE

---

- 3) Pharmacy Delivery:
- a. If a drug requires hand delivery as determined by the pharmacy consultant, the per diem allowance for pharmacy delivery for each type of drug is calculated by adding a per trip non-labor and labor calculation. The sum of these two components is multiplied by 1.5 to account for overhead.
    - i. The non-labor portion is calculated using an estimated average mileage per trip multiplied by the federal mileage allowance in effect at the time of the calculation.
    - ii. The labor portion is calculated by multiplying an estimated travel time for each delivery by an estimated salary and benefits for a delivery person. The per trip delivery calculation is then multiplied by the estimated number of trips necessary for the therapy being evaluated.
  - b. If a drug may be shipped as determined by the pharmacy consultant, the per diem allowance for pharmacy delivery for each type of drug is calculated by taking the national average of freight out shipping charges multiplied by 1.1 to include an administration factor.

Averages in items C. 3 a) & b) of this paragraph are derived using actuarial calculations.

---

TN. No.: 06-011  
Supersedes  
TN. No.: 91-53

Approval Date: 12/22/06

Effective Date: 09/01/06

MEDICAL ASSISTANCE  
State: NORTH CAROLINA

PAYMENTS FOR MEDICAL AND REMEDIAL CARE AND SERVICE

---

- 4) Nursing Supplies: the per diem for nursing supplies associated with nursing services is calculated using an estimate of national average units for supplies associated with nursing services, derived using actuarial calculations. The units are priced using the same method as the parental and enteral rate calculations for supplies associated with nursing services.
- 5) Equipment: the per diem rate for equipment necessary for the IV therapies is calculated using the same rate used in the parental and enteral rate calculations (all averages are derived using actuarial calculations).

---

TN. No.: 06-011  
Supersedes  
TN. No.: 91-53

Approval Date: 12/22/06

Effective Date: 09/01/06

MEDICAL ASSISTANCE  
State: NORTH CAROLINA

PAYMENTS FOR MEDICAL AND REMEDIAL CARE AND SERVICE

=====

In those cases where a patient is receiving more than one type of IV drug therapy simultaneously, the primary therapy will be reimbursed using the rate established in subparagraphs C 1) through 5) of this Paragraph. Any additional therapy will be reimbursed at a lesser per diem allowance calculated at the percentage levels as listed in a through d.

- (a) 75% of the pharmacy services per diem,
- (b) 100% of pharmacy supplies per diem,
- (c) 50% of the nursing supplies per diem, and
- (d) 100% of the necessary additional equipment per diem. The provider will indicate (an) additional therapy/ies on the claim using the method indicated in the published clinical policy.

If a patient's drug regimen changes or the patient dies after a pharmacy delivery has been made but before usage of the entire drug issued, the following components of the appropriate per diems will be paid for the remaining days of the prescription up to seven (7) days: pharmacy services, pharmacy supplies and pharmacy delivery.

Once the per diem rate has been determined, it will be updated each September 1 based on the forecast of the Gross National Product: Implicit Price Deflator notwithstanding any other provision. The calculations described in subparagraphs C 1) through 5) of this paragraph may be calculated every five (5) years at the discretion of the DHHS NC Division of Medical Assistance. If specified, the therapy services rates will be adjusted as shown on Attachment 4.19-B, Supplement 1, Page 2, of the state plan.

Tocolytic therapy, when administered, is a separate administration of HIT. The rate is not affected by the administration of HIT therapies.



MEDICAL ASSISTANCE  
State: NORTH CAROLINA

PAYMENTS FOR MEDICAL AND REMEDIAL CARE AND SERVICE

---

II. HIT Nursing Services:

The per diem for nursing services for each type of drug therapy is calculated using the nursing visit payment for a skilled nurse from the Home Health Fee schedule described in Section 7 of Attachment 4.19-B, multiplied by an average number of monthly visits for each type of therapy then divided by thirty (30).

In the case of amphotericin therapy, an additional hourly payment will be made for all hours exceeding two hours per visit. This payment will be made at the home health hourly fee for a private duty nurse as described in Section 7 of Attachment 4.19-B. The additional payment will be provided for other drug therapies upon specific approval by the DHHS Division of Medical Assistance.

III. HIT Drugs:

Payment for home IV drug therapies is made at 100percent of the lesser of the actual charge or the applicable per diem fee schedule allowance. Drug prices will be established in accordance with the Pharmacy Plan in Section 12 of Attachment 4.19-B.

---

TN. No.: 06-011  
Supersedes  
TN. No.: NEW

Approval Date: 12/22/06

Effective Date: 09/01/06

MEDICAL ASSISTANCE  
State: NORTH CAROLINA

PAYMENTS FOR MEDICAL AND REMEDIAL CARE AND SERVICE

---

IV. General

Rates for supplies and equipment shall be consistent among the HIT, Home Health (HH), and DME programs, as referenced in Attachment 4.19-B, Section 7.

If, as of September 1, 2006, a rate for an individual supply or equipment usage/purchase is different in either HH or HIT from the DME rate, the DME rate will be used unless the DME rate is the lower rate. In that case, no rate increases will be applied to the item in either HIT or HH until the DME rate is equal or greater than the rate of HH or HIT in effect on September 1, 2006. Once the DME rate for the item exceeds the existing rate for HIT or HH, those programs will adopt the DME rate.

All public and private providers are paid in accordance with the same published fee schedule as provided on the NC Division of Medical Assistance Web site @ <http://www.ncdhhs.gov/dma/fee/fee.htm>.

There will be no retroactive payment adjustments for fee changes.

---

TN. No.: 11-043  
Supersedes  
TN. No.: 06-011

Approval Date: 11-10-11

Effective Date: 08/31/2011

MEDICAL ASSISTANCE  
State: NORTH CAROLINA

PAYMENTS FOR MEDICAL AND REMEDIAL CARE AND SERVICE

---

8. Private Duty Nursing Services. (PDN)
- A. Private duty nursing services are reimbursed at the lower of billed customary charges or an established hourly rate. Effective October 1, 2002, this rate, is adjusted annually by the percentage change in the rate for a skilled nursing visit by a home health agency. Effective November 1, 2010, the RN rate is paid at Fee Schedule and will be billed with a code and modifier as defined in Clinical Policy, Attachment 3.1-A-1. Notwithstanding any other provision, if specified these rates will be adjusted as shown on Supplement 1 to the 4.19-B section of the state plan. Except as otherwise noted in the plan, state-developed fee schedule rates are the same for both governmental and private providers. The agency's fee schedule rate is effective October 1, 2009 and is effective for services provided on or after this date. All rates are published on the agency's fee schedule, <http://www.ncdhhs.gov/dma/fee/index.htm>. Except as otherwise noted in the plan, this fee schedule rate shall be inflated forward annually by the Medicare Market Basket Index.
- B. Effective October 1, 1993, payment for Private Duty Nursing Medical Supplies, except those related to provision and use of DME shall be reimbursed at the lower of a provider's billed customary charges or the maximum fee established for certified home health agencies. If a new item is not covered by the DME program and Medicare allowable is available, the rate will be set at the Medicare allowable amount available to the Division of Medical Assistance. Fees will be established based on average, reasonable charges if a Medicare allowable amount cannot be obtained for a particular supply item. The Medicare allowable amounts will be those amounts based on the Market Basket Index available to the Division of Medical Assistance as of July 1 of each year.

MEDICAL ASSISTANCE  
State: NORTH CAROLINA

PAYMENT FOR MEDICAL AND REMEDIAL CARE AND SERVICES

=====

9. Clinic Services provided by Health Departments

- a. Interim payments for Clinic Services covered under Attachment 3.1-A.1 are equal to the lower of the submitted charge or the appropriate fee from the North Carolina Medicaid Health Department Fee Schedule. The agency's interim rates were set as of March 1, 2011 and are effective on or after that date. All rates are published on the website at <http://www.ncdhhs.gov/dma/fee/index.htm>. Except as otherwise noted in the plan, State developed fee schedule rates are the same for all governmental and non-governmental providers. Payments will be based on settled cost, while interim rates will be based on the March 1, 2011 North Carolina fee schedule.

To assure payments do not exceed the upper payment limits set forth at 42 CFR 447.321, Health Department services reimbursed under a fee schedule and furnished to Medicaid recipients will be cost settled annually to Medicaid allowable costs. Effective for cost reporting periods beginning on or after July 1, 2011, Medicaid-allowable cost will be determined by the Division of Medical Assistance using a CMS approved cost reporting methodology.

MEDICAL ASSISTANCE  
State: NORTH CAROLINA

PAYMENT FOR MEDICAL AND REMEDIAL CARE AND SERVICES

---

Notwithstanding Attachment 4.19-B, Section 5, Page 3, services for ante partum codes, delivery codes and post partum codes which are billed by Health Departments for physicians, nurse midwives, and nurse practitioners who are salaried employees of a Health Department and whose compensation is included in the service cost of a Health Department when the Health Department is a Pregnancy Medical Home (PMH) as described in Attachment 3.1-B, Page 7(a) and Attachment 3.1-F shall be settled to cost in accordance with the provisions of this Section.

Additionally this cost methodology does not apply to the reimbursement for services furnished to Medicaid recipients for Laboratory Services as described in Attachment 4.19-B, Section 3, Page 1. These services are reimbursed fee-for-service only and Health Department costs for these services shall be excluded from cost settlement.

A. Direct Medical Services Payment Methodology:

The annual cost settlement methodology will consist of a CMS approved cost report, actual time report and reconciliation. If Medicaid payments exceed Medicaid-allowable costs, the excess will be recouped and the Federal share will be returned on the CMS-64 report.

To determine the Medicaid-allowable direct and indirect costs of providing direct medical services to Medicaid recipients receiving Clinic, Family Planning and Family Planning Waiver services in the Health Department the following steps are performed:

- (1) Direct costs for medical service include payroll costs and other costs that can be directly charged to direct medical services. Direct payroll costs include total compensation of direct services of personnel providing direct medical services.

Other direct costs include non-personnel costs directly related to the delivery of medical services, such as purchased services, capital outlay, materials and supplies. These direct costs are accumulated on the annual cost report, resulting in total direct costs.

- (2) Total direct costs for direct medical services from Item A 1 above are reduced on the cost report by any restricted public health service grant payments as defined in CMS Publication 15-1 resulting in adjusted direct costs for direct medical services.

MEDICAL ASSISTANCE  
State: NORTH CAROLINA

PAYMENT FOR MEDICAL AND REMEDIAL CARE AND SERVICES

---

- (3) Indirect costs include payroll costs and other costs related to the administration and operation of the Health Department. Indirect payroll costs include total compensation of Health Department administrative personnel providing administrative services.
- Other indirect costs include non-personnel costs related to the administration and operation of the health department such as purchased services, capital outlay, materials and supplies. Other indirect costs also include indirect costs allocated from the county to the Health Department via the county Cost Allocation Plan.
- (4) Total indirect costs from Item A 3 above are reduced on the cost report by any restricted public health service grant payments as defined in CMS Publication 15-1 resulting in adjusted indirect costs.
- (5) Clinical Administrative costs include payroll costs and other costs which directly support medical service personnel furnishing direct medical services. Clinical administrative payroll costs include total compensation of clinical administrative personnel furnishing direct support services.
- Other clinical administrative costs include non-personnel costs related to the support of direct medical services such as purchased services, capital outlay, materials and supplies.
- (6) Total clinical administrative costs from Item A 5 above are reduced on the cost report by any restricted public health service grant payments as defined in CMS Publication 15-1 resulting in adjusted clinical administrative costs.
- (7) Total adjusted indirect costs from Item A 4 above are allocated based on accumulated cost to Direct, Clinical Administrative, Laboratory, and Non-Reimbursable cost centers.
- (8) Total adjusted Clinical Administrative costs from Item A 7 above are allocated based on accumulated cost from Item A 7 to Direct and Laboratory cost centers.
- (9) An actual time report is used to determine the percentage of time spent by medical service personnel on Medicaid covered services, administrative duties, and non-reimbursable activities.
- (10) The total allowable cost for Direct Medicaid covered services is calculated by multiplying the percentage of actual time spent on Medicaid covered services from Item A 9 by the accumulated cost in Direct service cost centers from Item A 8 above.

MEDICAL ASSISTANCE  
State: NORTH CAROLINA

PAYMENT FOR MEDICAL AND REMEDIAL CARE AND SERVICES

---

- (11) For cost reporting periods beginning on or after July 1, 2010 and ending on or before June 30, 2012, the Medicaid percentage of covered services is calculated by dividing the Total Medicaid Encounters by Total Encounters. For cost reporting periods beginning on or after July 1, 2012, the Medicaid percentage of covered services shall use usual and customary charges and is calculated by dividing Total Medicaid Charges by Total Charges.
- (12) Total Medicaid allowable cost is calculated by multiplying the Medicaid percentage of covered services from Item A 11 above by the total allowable cost for Direct Medicaid covered services from Item A 10 above.
- (13) Total Medicaid Clinic cost is calculated by multiplying Total Medicaid allowable cost from Item A 12 by the ratio of Medicaid clinic charges to Medicaid total charges from Exhibit 2 of the cost report.

Total Medicaid Family Planning cost is calculated by multiplying Total Medicaid allowable cost from Item A 12 by the ratio of Medicaid Family Planning charges to Medicaid total charges from Exhibit 2 of the cost report.

Total Medicaid Family Planning Waiver cost is calculated by multiplying Total Medicaid allowable cost from Item A 12 by the ratio of Medicaid Family Planning Waiver charges to Medicaid total charges from Exhibit 2 of the cost report.

B. Certification of Expenditures:

On an annual basis, each Health Department will certify through its cost report its total actual, incurred Medicaid allowable costs. Providers are only permitted to certify Medicaid allowable costs.

C. Annual Cost Report Process:

For Medicaid covered services each health department shall file an annual cost report as directed by the Division of Medical Assistance in accordance with 42 CFR 413 Subpart B and 42 CFR 447.202. The Medicaid cost report is due five (5) months after the provider's fiscal year end. Providers that fail to fully and accurately complete Medicaid cost reports within the time period specified by the Division of Medical Assistance or that fail to furnish required documentation and disclosures for Medicaid cost reports required under this Plan within the time period specified by the Division, may be subject to withhold penalties for non-compliance. A 20 percent withhold of Medicaid payments will be imposed upon the delinquent provider 30 days after the Medicaid cost report filing deadline unless the provider has made a written request for an extension of the Medicaid cost report filing due date to the Division of Medical Assistance and has received a written approval from the Division of Medical Assistance. The withholding of monies will continue until the Medicaid cost report filing requirements have been satisfied. Once, all requirements have been satisfied withheld monies will be released to the provider. Any monies withheld will not accrue interest to the benefit of the provider.

MEDICAL ASSISTANCE  
State: NORTH CAROLINA

PAYMENT FOR MEDICAL AND REMEDIAL CARE AND SERVICES

---

The primary purposes of the governmental cost report are to:

- (1) Document the provider's total CMS-approved, Medicaid-allowable costs of delivering Medicaid covered services using a CMS-approved cost allocation methodology and cost report.
- (2) Reconcile annual interim payments to total CMS-approved, Medicaid - allowable costs using a CMS approved cost allocation methodology and cost report.

D. The Cost Reconciliation Process:

The cost reconciliation process must be completed within twelve months of the end of the reporting period covered by the annual Health Department Cost Report. The total Medicaid-allowable costs are determined based in accordance with 42 CFR 413 Subpart B and the CMS Provider Reimbursement Manual methodology and are compared to the Health Department Medicaid interim payments delivered during the reporting period as documented in the Medicaid Management Information System (MMIS), resulting in a cost reconciliation.

E. The Cost Settlement Process:

If a provider's interim payments exceed the provider's certified cost for Medicaid services furnished in health departments to Medicaid recipients, the provider will remit the excess federal share of the overpayment at the time the cost report is submitted. The federal share will be returned via CMS-64 Report.

If the certified cost of a health department provider exceeds the interim payments, the Division of Medical Assistance will pay the federal share of the difference to the provider in accordance with the final actual certification agreement and submit claims to the CMS for reimbursement of that payment in the federal fiscal quarter following payment to the provider.



State Plan Under Title XIX of the Social Security Act  
Medical Assistance Program  
State: North Carolina

Payments for Medical and Remedial Care and Services

---

b. End-Stage Renal Disease (ESRD) Services

The Division of Medical Assistance Freestanding Dialysis Facility rates were set equal to the 2005 Medicare composite rates as of January 1, 2005 and are effective for services on or after that date. The existing providers will continue to receive reimbursement at their specific rate established prior to July 1, 2008. Medicaid providers enrolled on or after July 1, 2008 will receive a rate equal to the simple average of the composite rate of existing providers and will receive written notification of their Medicaid composite rate and effective date. Rates are the same for both governmental and private providers of licensed freestanding kidney dialysis centers.

Notwithstanding any other provision, if specified, these rates will be adjusted as shown on Attachment 4.19-B, Supplement 2, Page 1c of the State Plan.

---

TN. No: 12-002  
Supersedes  
TN. No: 08-002

Approval Date: 08-30-12

Effective Date: 04/01/2012

State Plan Under Title XIX of the Social Security Act  
Medical Assistance Program  
State: North Carolina

Payments for Medical and Remedial Care and Services

---

- c. Services provided by licensed Ambulatory Surgical Centers are reimbursed at ninety-five percent of the Medicare Ambulatory Surgical Centers fee schedule in effect on January of each year.

Additional ancillary services, such as laboratory, x-ray and general anesthesia services, are reimbursed at the comparable fees paid to other providers. Notwithstanding any other provision, if specified, these rates will be adjusted as shown on Attachment 4.19-B, Supplement 2, Page 1d of the State Plan.

Except as otherwise noted in the plan, State developed fee schedule rates are the same for both governmental and private providers of licensed Ambulatory Surgical Centers and the fee schedule and any annual/periodic adjustments to the fee schedules are published on the NC Division of Medical Assistance Web site <http://www.ncdhhs.gov/dma/fee/fee.htm>.

---

TN. No.: 09-016  
Supersedes  
TN. No.: 08-002

Approval Date: 12-18-09

Effective Date: 07/01/2009

MEDICAL ASSISTANCE  
State: NORTH CAROLINA

PAYMENTS FOR MEDICAL AND REMEDIAL CARE AND SERVICE

---

d. Freestanding Birth Center Services:

Payments for Freestanding Birth Centers Services covered under Attachment 3.1-A are equal to the lower of the submitted charge or the appropriate fee from the North Carolina Medicaid Freestanding Birth Center Services Fee Schedule.

- (a) Effective October 6, 2011, the rate for Freestanding Birth Center Services is an all inclusive fee schedule facility rate. The rate is initially established at 80% of the hospital reimbursement for a vaginal delivery without complications using the DRG 775 weight and 45<sup>th</sup> percentile DRG Base rate in effect October 1, 2011. Freestanding Birth Center Services shall be inflated forward by the Medicare Market Basket Index in effect each January 1<sup>st</sup>.
- (b) Reimbursement for Freestanding Birth Center procedures discontinued subsequent to the patient's surgical preparation, but prior to the administration of anesthesia (local, regional block, or general) will be 50% of the allowable for the procedure.

The agency's rate was set as of October 6, 2011 and is effective on or after that date. The Fee Schedule rate is published on the agency's website at <http://www.ncdhhs.gov/dma/fee/index.htm>. Except as otherwise noted in the plan, State developed fee schedule rates are the same for both governmental and private providers.

- (c) Notwithstanding any other provision, if specified, this rate will be adjusted as shown on Attachment 4.19B, Supplement 1, Page 4 of the State Plan.
- (d) Freestanding Birth Center Services reimbursed under a fee schedule are not subject to cost settlement.

..

State Plan Under Title XIX of the Social Security Act  
Medical Assistance Program  
State: North Carolina

Payments for Medical and Remedial Care and Services

---

10. Dental services.

Payments for dental services shall be equal to the lower of the submitted charge or the appropriate fee from the Dental fee schedule, in effect *on January 1, 1995*, except for payments to the University of North Carolina Dental School which will be reimbursed at the maximum amount from the fee schedule and cost settled at year end.

- A. Annual rate adjustments will occur January 1<sup>st</sup>. At no time shall the rate for any new dental code or any future rate increases exceed 75% of the National Dental Advisory Service (NDAS) 50% median effective July 1<sup>st</sup>, of the prior year.
- B. For calendar year 2002 only, the Division of Medical Assistance shall increase dental fees based on access to care in lieu of inflationary increases. Dental codes increased in the year 2002 based on access to care may be modified but will not exceed 75% of the National Dental Advisory Service 50% median or the percentage increase granted by the North Carolina State Legislature.
- C. Fees for new services are established based on the fees for similar existing services. If there are no similar services the fee is set at 75 percent of the estimated average charge until an NDAS median is established.
- D. Fees for services deemed to be associated with adequacy of access to health care services may be increased or decreased based on administrative review. The service must be essential to the health needs of the Medicaid recipients, no other comparable treatment available and a fee adjustment must be necessary to maintain dental participation at a level adequate to meet the needs of Medicaid recipients.
- E. Notwithstanding any other provision, if specified, these rates will be adjusted as shown on Attachment 4.19-B, Supplement 3, Page 1 of the State Plan.
- F. The agency's rates were set as of January 1<sup>st</sup> and are effective on or after that date. All rates are published on the website at [www.dhhs.state.nc.us/dma/fee/dentalfee.pdf](http://www.dhhs.state.nc.us/dma/fee/dentalfee.pdf). Except as otherwise noted in the plan, State developed fee schedule rates are the same for both governmental and private providers.

---

TN. No: 07-003  
Supersedes  
TN. No: 02-03

Approval Date: 11/24/08

Eff. Date 01/01/2007

MEDICAL ASSISTANCE  
State: NORTH CAROLINA

PAYMENTS FOR MEDICAL AND REMEDIAL CARE AND SERVICE

---

12. Prescribed drugs, dentures, and prosthetic devices; and eyeglasses prescribed by a physician skilled in diseases of the eye or by an optometrist.

a. Prescribed Drugs:

Reimbursement for legend and non-legend drugs shall not exceed the federal upper limit defined as the lowest of:

1. The Estimated Acquisition Cost (EAC) defined as the Average Acquisition Cost (AAC) plus a reasonable professional dispensing fee;
2. The provider's usual and customary charge to the general public;
3. The amount established by the North Carolina State determined upper payment limit plus a reasonable professional dispensing fee (this provision does not apply when there is only one enrolled pharmacy provider in the county); or
4. The North Carolina calculated aggregate FUL. This will be submitted to CMS on an annual basis.

A professional dispensing fee will not be paid for prescriptions refilled in the same month, whether it is the same drug or generic equivalent drug.

Multiple Source Drugs – North Carolina has implemented a State determined list of multiple source drugs. All drugs on this list are reimbursed at limits set by the State unless the provider writes in their own handwriting, brand name drug is “medically necessary”.

The rate for Specialty Pharmacy products is the maximum allowable cost set by the State Agency. The rate used is dependent upon the actual acquisition cost for the drug. Specialty drugs are those used for beneficiaries with complex and chronic diseases that require expensive and challenging drug regimens.

---

TN No.: 14-047  
Supersedes  
TN No.: 11-054

Approval Date: 01-07-16

Effective Date: 01/01/2016

MEDICAL ASSISTANCE  
State: NORTH CAROLINA

PAYMENTS FOR MEDICAL AND REMEDIAL CARE AND SERVICE

---

12. Prescribed drugs, dentures, and prosthetic devices; and eyeglasses prescribed by a physician skilled in disease of the eye or by an optometrist.

b. North Carolina Average Acquisition Cost (AAC) For Prescribed Drugs:

As determined by the North Carolina General Assembly, effective January 1, 2016, North Carolina will base brand and generic drug ingredient pricing on an average acquisition cost (AAC). The AAC is defined as the price paid by pharmacies based on an average of actual acquisition costs determined by a survey of retail pharmacy providers. The National Average Drug Acquisition Cost (NADAC) pricing will be used for AAC when available. If NADAC is unavailable, then the AAC will be defined as Wholesale Acquisition Cost (WAC). For the WAC information, the Division uses the First Databank Price Update Service, manufacturer's price list, or other nationally published sources. Telephone contact with manufacturer or distributors may be utilized when a published source is not available. 340B providers must submit the actual purchased drug price as the usual and customary price if they dispense a 340B purchased drug.

c. Professional Dispensing Fee:

The professional dispensing fee is paid to all providers for the initial dispensing and excludes refills within the same month for the same drug or generic equivalent. The professional dispensing fee is \$3.98 for non-preferred brand drugs.

The generic and preferred brand professional dispensing fee will be based on an enrolled pharmacy's preferred brand and generic drugs during the previous quarter, as documented in the Medicaid Management Information System (MMIS). Based on the previous quarterly volume of an enrolled pharmacy, as documented in MMIS, the total number of generics and preferred brands is divided by the total number of prescriptions billed. Preferred brand drugs are brand drugs whose net cost to the State after consideration of all rebates is less than the cost of the generic equivalent.

The generic and preferred brand professional dispensing fee will be as follows:

- 85% or more claims per quarter - \$13.00
- Less than 85% claims per quarter - \$7.88

---

TN No.: 14-047

Supersedes

TN No.: 14-008

Approval Date: 01-07-16

Effective Date: 01/01/2016

MEDICAL ASSISTANCE  
State: NORTH CAROLINA

PAYMENTS FOR MEDICAL AND REMEDIAL CARE AND SERVICE

---

12. Prescribed drugs, dentures, and prosthetic devices; and eyeglasses prescribed by a physician skilled in disease of the eye or by an optometrist.

Physician Drug Program:

The physician drug program is reimbursed at the Average Sales Price plus 6% to follow Medicare pricing. If there is no ASP value available from Medicare, fees shall be established based on the lower of vendor specific National Drug Code (NDC) Average Wholesale Price (AWP) less 10% pricing as determined using lowest generic product NDC, lowest brand product NDC or a reasonable value compared to other physician drugs currently on North Carolina's physician drug program list.

Physician administered contraceptive drugs are reimbursed at the Wholesale Acquisition Cost (WAC) plus 6%.

Effective October 1, 2014, the rate for Botox when prescribed for medical use is equal to the rate established for pharmacy, which is set in accordance with Section 12, Page 1a.

Notwithstanding any other provision, if specified, these rates will be adjusted as shown on Attachment 4.19-B, Supplement 3, Page 2 of the State Plan.

Except as otherwise noted in the plan, State developed fee schedule rates are the same for both governmental and private providers of the physician drug program and the fee schedule and any annual/periodic adjustments to the fee schedules are published on the NC Division of Medical Assistance Web site <http://www.ncdhhs.gov/dma/fee/fee.htm>.

---

TN No.: 14-021  
Supersedes  
TN No.: 11-047

Approval Date: 12/12/2014

Effective Date: 07/01/2014

MEDICAL ASSISTANCE  
State: NORTH CAROLINA

PAYMENTS FOR MEDICAL AND REMEDIAL CARE AND SERVICE

---

THIS PAGE INTENTIONALLY LEFT BLANK

---

TN No.: 10-032  
Supersedes  
TN No.: 09-022

Approval Date: 05/24/11

Effective Date: 11/01/10



MEDICAL ASSISTANCE  
State: NORTH CAROLINA

PAYMENTS FOR MEDICAL AND REMEDIAL CARE AND SERVICE

---

---

THIS PAGE INTENTIONALLY LEFT BLANK

---

TN No.: 11-020  
Supersedes  
TN No.: 88-12

Approval Date: 10-20-11

Effective Date: 11/1/2011

MEDICAL ASSISTANCE  
State: NORTH CAROLINA

PAYMENTS FOR MEDICAL AND REMEDIAL CARE AND SERVICE

---

---

12. Prescribed drugs, dentures, and prosthetic devices; and eyeglasses prescribed by a physician skilled in disease of the eye or by an optometrist.

c. ORTHOTIC AND PROSTHETIC DEVICES

Payment for each claim for prosthetic/orthotic devices will be equal to the lower of the supplier's usual and customary billed charges or the maximum fee established for each item. The maximum fees are set at 100 percent of the Medicare Part B fees as of January 1 of each year. If a Medicare fee cannot be obtained for a particular item, the fee will be based on estimates of reasonable costs and updated each January 1 by the forecasted percentage increase in prices for the devices. Notwithstanding any other provision, if specified these rates will be adjusted as shown on Supplement 4 to the Attachment 4.19-B section of the state plan. There will be no retroactive payment adjustments for fee changes.

When devices are provided by state or local government agencies, reimbursement will not exceed the cost of the device.

All rates are published on the agency's website. Except as otherwise noted in the plan, state developed fee schedule rates are the same for both governmental and private providers of Orthotic and Prosthetic Devices the fee schedule and any annual/periodic adjustments to the fee schedule are published in <http://www.ncdhhs.gov/dma/fee/fee/htm>. The agency's fee schedule rate was set as of the January 1 of each year and is effective for services provided on or after that date. All rates are published on the agency's website.

State Plan Under Title XIX of the Social Security Act  
Medical Assistance Program  
State: North Carolina

---

Payments for Medical and Remedial Care and Services

---

12. Prescribed drugs, dentures, and prosthetic devices; and eyeglasses prescribed by a physician skilled in diseases of the eye or by an optometrist.

- d. Eyeglasses.

Fees paid to dispensing providers are negotiated fees established by the State agency based on industry charges. Notwithstanding any other provision, if specified, these rates will be adjusted as shown on Attachment 4.19-B, Supplement 3, Page 1c of the State Plan.

All rates are published on the agency's website. Except as otherwise noted in the plan, state developed fee schedule rates are the same for both governmental and private providers of Orthotic and Prosthetic Devices the fee schedule and any annual/periodic adjustments to the fee schedule are published in <http://www.ncdhhs.gov/dma/fee/fee/htm>. The agency's fee schedule rate was set as of the October 1, 2009 and is effective for services provided on or after that date. All rates are published on the agency's website.

Payment for materials is made to a contractor(s) in accordance with 42 CFR 431.54(d).

---

TN. No. 09-022  
Supersedes  
TN. No. 05-012

Approval Date: 09/23/10

Effective Date: 10/01/09

MEDICAL ASSISTANCE  
State: North Carolina

PAYMENTS FOR MEDICAL AND REMEDIAL CARE AND SERVICE

---

13. D. OTHER DIAGNOSTIC SCREENING PREVENTIVE AND REHABILITATIVE SERVICES

- 1). Medically Monitored or Alcohol Drug Addiction Treatment Center Detoxification/Crisis Stabilization (Adult – H2036) An individual facility rate will be determined as follows:

Reimbursement rates are determined on the basis of provider specific pro forma cost information. Providers submit cost templates and a reimbursement rate is established utilizing cost modeling. The cost model is based on agency estimates. The residential facility cost model recognizes direct care service costs for staff salaries and fringe benefits and includes qualified, associate and paraprofessionals. Other direct service costs recognized include accreditation, communications, training, and travel costs. Facility overhead costs are recognized at 11% of total direct care service costs. A calculated per diem is determined by dividing total estimated days of service provided to recipients. This service is provided in accordance with Attachment 3.1-A.1 Page 15a.13, paragraph 13.D., subparagraph (xvii).

The facilities providing this service are not IMD facilities and NC Medicaid is not reimbursing room and board for this service.

Notwithstanding any other provision, if specified, these rates will be adjusted as shown on Attachment 4.19-B, Supplement 6 Page 1 section of the State Plan.

This service is not cost settled for any provider.

---

TN No: 11-034  
Supersedes  
TN No: 07-003

Approval Date: 03/05/12

Effective Date: 11/01/2011

MEDICAL ASSISTANCE  
State: North Carolina

PAYMENTS FOR MEDICAL AND REMEDIAL CARE AND SERVICE

---

2) Multi Systemic Therapy (H2033)

Except as otherwise noted in the plan, state-developed fee schedule rates are the same for both governmental and private providers of Multi Systemic Therapy. The agency's fee schedule rate of \$37.32 was set as of October 1, 2009 and is effective for services provided on or after that date. Except as otherwise noted in the plan, this per 15 minute rate shall be adjusted annually using the Medicare Market Basket Index. The fee schedule is published on the agency's website at <http://www.ncdhhs.gov/dma/fee/fee.htm>.

This service will be provided by direct enrolled Medicaid providers who may be either private or governmental. This service is not cost settled for any provider. This service is provided in accordance with Attachment 3.1-A.1 Page 7c.7, Paragraph 4.b.(8), subparagraph (h).

The facilities providing this service are not IMD facilities and NC Medicaid is not reimbursing room and board for this service.

Notwithstanding any other provision, if specified, this rate will be adjusted as shown on Attachment 4.19-B, Supplement 6 Page 2 section of the State Plan.

---

TN No: 11-034  
Supersedes  
TN No: 07-003

Approval Date: 03/05/12

Effective Date: 11/01/2011

MEDICAL ASSISTANCE

State: North Carolina

PAYMENTS FOR MEDICAL AND REMEDIAL CARE AND SERVICE

---

3) Ambulatory Detoxification (H0014)

Except as otherwise noted in the plan, state-developed fee schedule rates are the same for both governmental and private providers of Ambulatory Detoxification. The agency's fee schedule rate of \$21.68 was set as of October 1, 2009 and is effective for services provided on or after that date. Except as otherwise noted in the plan, this per 15 minute rate shall be adjusted annually using the Medicare Market Basket Index. The fee schedule is published on the agency's website at <http://www.ncdhhs.gov/dma/fee/fee.htm>.

This service will be provided by direct enrolled Medicaid providers who may be either private or governmental. This service is not cost settled for any provider. This service is provided in accordance with Attachment 3.1-A.1 Page 7c.9, Paragraph 4.b.(8), subparagraph (j) and Attachment 3.1-A.1 Page 15a.12, Paragraph 13.D., subparagraph (xv).

The facilities providing this service are not IMD facilities and NC Medicaid is not reimbursing room and board for this service.

Notwithstanding any other provision, if specified, this rate will be adjusted as shown on Attachment 4.19-B, Supplement 6 Page 3 section of the State Plan.

---

TN No: 11-034

Supersedes

TN No: 07-003

Approval Date: 03/05/12

Effective Date: 11/01/2011

MEDICAL ASSISTANCE

State: North Carolina

PAYMENTS FOR MEDICAL AND REMEDIAL CARE AND SERVICE

---

4) Professional Treatment Services in Facility Based Crisis Programs (Adult – S9484)

Payment for Professional Treatment Services in Facility Based Crisis Programs is based on a per 1 hour increment. This service is provided in accordance with Attachment 3.1-A.1 Page 15a.8, Paragraph 13.D., sub paragraph (ix). Except as otherwise noted in the plan, state-developed fee schedule rates are the same for both governmental and private providers of Professional Treatment Services in Facility Based Crisis Programs. The agency's fee schedule rate of \$16.26 was set as of October 01, 2009 and is effective for services provided on or after that date. Except as otherwise noted in the plan, this rate shall be adjusted annually using the Medicare Market Basket Index. The fee schedule is published on the agency's website at <http://www.ncdhhs.gov/dma/fee/fee.htm>.

This service will be provided by direct enrolled Medicaid providers who may be either private or governmental. This service is not cost settled for any provider.

The facilities providing this service are not IMD facilities and NC Medicaid is not reimbursing room and board.

Notwithstanding any other provision, if specified, this rate will be adjusted as shown on Attachment 4.19-B, Supplement 6 Page 4 section of the State Plan.

MEDICAL ASSISTANCE

State: North Carolina

PAYMENTS FOR MEDICAL AND REMEDIAL CARE AND SERVICE

---

5) Facility-Based Crisis Program – Children and Adolescents (S9484 HA)

Payment for Facility-Based Crisis – Children and Adolescents is based on a per 1 hour increment. This service is provided in accordance with Attachment 3.1-A.1 Page 7c.9a, Paragraph 4.b.(8), subparagraph (k). Except as otherwise noted in the plan, state-developed fee schedule rates are the same for both governmental and private providers of Facility-Based Crisis Program – Children and Adolescents. The agency's fee schedule rate of \$16.26 was set as of October 1, 2009 and is effective for services provided on or after that date. Except as otherwise noted in the plan, this rate shall be adjusted annually using the Medicare Market Basket Index. The fee schedule is published on the agency's website at <http://www.ncdhhs.gov/dma/fee/fee.htm>.

This service will be provided by direct enrolled Medicaid providers who may be either private or governmental. This service is not cost settled for any provider.

The facilities providing this service are not IMD facilities and NC Medicaid is not reimbursing Room and board for this service.

Notwithstanding any other provision, if specified, this rate will be adjusted as shown on Attachment 4.19-B, Supplement 6 Page 5 section of the State Plan.

---

TN No: 11-034  
Supersedes  
TN No: 07-003

Approval Date: 03/05/12

Effective Date: 11/01/2011



MEDICAL ASSISTANCE

State: North Carolina

PAYMENTS FOR MEDICAL AND REMEDIAL CARE AND SERVICE

---

6) Substance Abuse Comprehensive Outpatient Treatment program (H2035)

Except as otherwise noted in the plan, state-developed fee schedule rates are the same for both governmental and private providers of Substance Abuse Comprehensive Outpatient Treatment program. The agency's fee schedule rate of \$46.28 was set as of October 1, 2009 and is effective for services provided on or after that date. Except as otherwise noted in the plan, this per 1 hour rate shall be adjusted annually using the Medicare Market Basket Index. The fee schedule is published on the agency's website at <http://www.ncdhhs.gov/dma/fee/fee.htm>.

This service will be provided by direct enrolled Medicaid providers who may be either private or governmental. This service is not cost settled for any provider. This service is provided in accordance with Attachment 3.1-A.1 Page 15a.10, Paragraph 13.D., subparagraph (xii).

The facilities providing this service are not IMD facilities and NC Medicaid is not reimbursing room and board for this service.

Notwithstanding any other provision, if specified, these rates will be adjusted as shown on Attachment 4.19-B, Supplement 6 Page 6 section of the State Plan.

---

TN No: 11-034  
Supersedes  
TN No: 07-003

Approval Date: 03/05/12

Effective Date: 11/01/2011

MEDICAL ASSISTANCE

State: North Carolina

PAYMENTS FOR MEDICAL AND REMEDIAL CARE AND SERVICE

---

7) Intensive In-Home Services (H2022)

Except as otherwise noted in the plan, state-developed fee schedule rates are the same for both governmental and private providers of Intensive In-Home Services. The agency's fee schedule rate of \$258.20 was set as of October 1, 2009 and is effective for services provided on or after that date. Except as otherwise noted in the plan, this per diem rate shall be adjusted annually Medicare Market Basket Index. The fee schedule is published on the agency's website at <http://www.ncdhhs.gov/dma/fee/fee.htm>.

This service will be provided by direct enrolled Medicaid providers who may be either private or governmental. This service is not cost settled for any provider. This service is provided in accordance with Attachment 3.1-A.1 Page 7c.6, Paragraph 4.b, subparagraph (g).

The facilities providing this service are not IMD facilities and NC Medicaid is not reimbursing room and board for this service.

Notwithstanding any other provision, if specified, these rates will be adjusted as shown on Attachment 4.19-B, Supplement 6 Page 7 section of the State Plan.

---

TN No: 11-034  
Supersedes  
TN No: 07-003

Approval Date: 03/05/12

Effective Date: 11/01/2011

MEDICAL ASSISTANCE  
State: North Carolina

PAYMENTS FOR MEDICAL AND REMEDIAL CARE AND SERVICE

---

8) Substance Abuse Intensive Outpatient Program (H0015)

Except as otherwise noted in the plan, state-developed fee schedule rates are the same for both governmental and private providers of Substance Abuse Intensive Outpatient Program. The agency's fee schedule rate of \$134.24 was set as of October 1, 2009 and is effective for services provided on or after that date. Except as otherwise noted in the plan, this per diem rate shall be adjusted annually using the Medicare Market Basket Index. The fee schedule is published on the agency's website at <http://www.ncdhhs.gov/dma/fee/fee.htm>.

This service will be provided by direct enrolled Medicaid providers who may be either private or governmental. This service is not cost settled for any provider. This service is provided in accordance with Attachment 3.1-A.1 Page 7c.8, Paragraph 4.b.(8), subparagraph (i) and Attachment 3.1-A.1 Page 15a.9-A, Paragraph 13.D, subparagraph (xi).

The facilities providing this service are not IMD facilities and NC Medicaid is not reimbursing room and board for this service.

Notwithstanding any other provision, if specified, these rates will be adjusted as shown on Attachment 4.19-B, Supplement 6 Page 8 section of the State Plan.

---

TN No: 11-034  
Supersedes  
TN No: 07-003

Approval Date: 03/05/12

Effective Date: 11/01/2011

MEDICAL ASSISTANCE

State: North Carolina

PAYMENTS FOR MEDICAL AND REMEDIAL CARE AND SERVICE

---

9) Substance Abuse Non-medical Community Residential Treatment (H0012HB)

Except as otherwise noted in the plan, state-developed fee schedule rates are the same for both governmental and private providers of Substance Abuse Non-medical Community Residential Treatment. The agency's fee schedule rate of \$158.99 was set as of October 1, 2009 and is effective for services provided on or after that date. Except as otherwise noted in the plan, this per diem rate shall be adjusted annually using the Medicare Market Basket Index. The fee schedule is published on the agency's website at <http://www.ncdhhs.gov/dma/fee/fee.htm>.

This service will be provided by direct enrolled Medicaid providers who may be either private or governmental. This service is not cost settled for any provider. This service is provided in accordance with Attachment 3.1-A.1 Page 15a.11, Paragraph 13.D, subparagraph (xiii).

The facilities providing this service are not IMD facilities and NC Medicaid is not reimbursing room and board for this service.

Notwithstanding any other provision, if specified, these rates will be adjusted as shown on Attachment 4.19-B, Supplement 6 Page 9 section of the State Plan.

---

TN No: 11-034

Supersedes

TN No: 08-011

Approval Date: 03/05/12

Effective Date: 11/01/2011

MEDICAL ASSISTANCE

State: North Carolina

PAYMENTS FOR MEDICAL AND REMEDIAL CARE AND SERVICE

---

10) Substance Abuse Medically Monitored Community Residential Treatment (H0013)

Except as otherwise noted in the plan, state-developed fee schedule rates are the same for both governmental and private providers of Substance Abuse Medically Monitored Community Residential Treatment. The agency's fee schedule rate of \$246.74 was set as of October 1, 2009 and is effective for services provided on or after that date. Except as otherwise noted in the plan, this per diem rate shall be adjusted annually using the Medicare Market Basket Index. The fee schedule is published on the agency's website at <http://www.ncdhhs.gov/dma/fee/fee.htm>.

This service will be provided by direct enrolled Medicaid providers who may be either private or governmental. This service is not cost settled for any provider. This service is provided in accordance with Attachment 3.1-A.1 Page 15a.11-A, Paragraph 13.D, subparagraph (xiv).

The facilities providing this service are not IMD facilities and NC Medicaid is not reimbursing room and board for this service.

Notwithstanding any other provision, if specified, these rates will be adjusted as shown on Attachment 4.19-B, Supplement 6 Page 10 section of the State Plan.

---

TN No: 11-034  
Supersedes  
TN No: 07-003

Approval Date: 03/05/12

Effective Date: 11/01/2011

MEDICAL ASSISTANCE

State: North Carolina

PAYMENTS FOR MEDICAL AND REMEDIAL CARE AND SERVICE

---

11) Non Hospital Medical Detoxification (Adult – H0010)

Except as otherwise noted in the plan, state-developed fee schedule rates are the same for both governmental and private providers of Non Hospital Medical Detoxification. The agency's fee schedule rate of \$332.22 was set as of October 1, 2009 and is effective for services provided on or after that date. Except as otherwise noted in the plan, this per diem rate shall be adjusted annually using the Medicare Market Basket Index. The fee schedule is published on the agency's website at <http://www.ncdhhs.gov/dma/fee/fee.htm>.

This service will be provided by direct enrolled Medicaid providers who may be either private or governmental. This service is not cost settled for any provider. This service is provided in accordance with Attachment 3.1-A.1 Page 15a.12-A, Paragraph 13.D, subparagraph (xvi).

The facilities providing this service are not IMD facilities and NC Medicaid is not reimbursing room and board for this service.

Notwithstanding any other provision, if specified, these rates will be adjusted as shown on Attachment 4.19-B, Supplement 6 Page 11 section of the State Plan.

---

TN No: 11-034  
Supersedes  
TN No: 10-002

Approval Date: 03/05/12

Effective Date: 11/01/2011

MEDICAL ASSISTANCE

State: North Carolina

PAYMENTS FOR MEDICAL AND REMEDIAL CARE AND SERVICE

---

12) Partial Hospital (H0035)

Except as otherwise noted in the plan, state-developed fee schedule rates are the same for both governmental and private providers of Partial Hospital. The agency's fee schedule rate of \$135.02 was set as of October 1, 2009 and is effective for services provided on or after that date. Except as otherwise noted in the plan, this per diem rate shall be adjusted annually using the Medicare Market Basket Index. The fee schedule is published on the agency's website at <http://www.ncdhhs.gov/dma/fee/fee.htm>.

This service will be provided by direct enrolled Medicaid providers who may be either private or governmental. This service is not cost settled for any provider. This service is provided in accordance with Attachment 3.1-A.1 Page 7c. 5, Paragraph 4.b.(8), subparagraph (e) and Attachment 3.1-A.1 Page 15a.4, Paragraph 13.D., subparagraph (v).

The facilities providing this service are not IMD facilities and NC Medicaid is not reimbursing room and board for this service.

Notwithstanding any other provision, if specified, these rates will be adjusted as shown on Attachment 4.19-B, Supplement 6 Page 12 section of the State Plan.

---

TN No: 11-034  
Supersedes  
TN No: 10-002

Approval Date: 03/05/12

Effective Date: 11/01/2011

MEDICAL ASSISTANCE

State: North Carolina

PAYMENTS FOR MEDICAL AND REMEDIAL CARE AND SERVICE

---

13) Assertive Community Treatment Team (ACTT) (Adult – H0040)

Except as otherwise noted in the plan, state-developed fee schedule rates are the same for both governmental and private providers of Assertive Community Treatment Team. The agency's fee schedule rate of \$301.35 was set as of October 1, 2009 and is effective for services provided on or after that date. Except as otherwise noted in the plan, this per event rate shall be adjusted annually using the Medicare Market Basket Index. The fee schedule is published on the agency's website at <http://www.ncdhhs.gov/dma/fee/fee.htm>.

This service will be provided by direct enrolled Medicaid providers who may be either private or governmental. This service is not cost settled for any provider. This service is provided in accordance with Attachment 3.1-A.1 Page 15a.7, Paragraph 13.D., subparagraph (viii).

The facilities providing this service are not IMD facilities and NC Medicaid is not reimbursing room and board for this service.

Notwithstanding any other provision, if specified, these rates will be adjusted as shown on Attachment 4.19-B, Supplement 6 Page 13 section of the State Plan.

---

TN No: 11-034

Supersedes

TN No: 10-002

Approval Date: 03/05/12

Effective Date: 11/01/2011



MEDICAL ASSISTANCE

State: North Carolina

PAYMENTS FOR MEDICAL AND REMEDIAL CARE AND SERVICE

---

14) Diagnostic Assessment (T1023)

Except as otherwise noted in the plan, state-developed fee schedule rates are the same for both governmental and private providers of Diagnostic Assessment. The agency's fee schedule rate of \$236.02 was set as of October 1, 2009 and is effective for services provided on or after that date. Except as otherwise noted in the plan, this per event rate shall be adjusted annually using the Medicare Market Basket Index. The fee schedule is published on the agency's website at <http://www.ncdhhs.gov/dma/fee/fee.htm>.

This service will be provided by direct enrolled Medicaid providers who may be either private or governmental. This service is not cost settled for any provider. This service is provided in accordance with Attachment 3.1-A.1 Page 7c.2, Paragraph 4.b.(8), subparagraph (b) and Attachment 3.1-A.1 Page 15a.1, Paragraph 13.D., subparagraph (ii).

The facilities providing this service are not IMD facilities and NC Medicaid is not reimbursing room and board for this service.

Notwithstanding any other provision, if specified, these rates will be adjusted as shown on Attachment 4.19-B, Supplement 6 Page 14 section of the State Plan.

---

TN No: 11-034

Supersedes

TN No: 10-002

Approval Date: 03/05/12

Effective Date: 11/01/2011

MEDICAL ASSISTANCE

State: North Carolina

PAYMENTS FOR MEDICAL AND REMEDIAL CARE AND SERVICE

---

15) Opioid Treatment (H0020)

Except as otherwise noted in the plan, state-developed fee schedule rates are the same for both governmental and private providers of Opioid Treatment. The agency's fee schedule rate of \$16.94 was set as of October 1, 2009 and is effective for services provided on or after that date. Except as otherwise noted in the plan, this per event rate shall be adjusted annually using the Medicare Market Basket Index. The fee schedule is published on the agency's website at <http://www.ncdhhs.gov/dma/fee/fee.htm>.

This service will be provided by direct enrolled Medicaid providers who may be either private or governmental. This service is not cost settled for any provider. This service is provided in accordance with Attachment 3.1-A.1 Page 15a.9, Paragraph 13.D., subparagraph (x).

The facilities providing this service are not IMD facilities and NC Medicaid is not reimbursing room and board for this service.

Notwithstanding any other provision, if specified, these rates will be adjusted as shown on Attachment 4.19-B, Supplement 6 Page 15 section of the State Plan.

---

TN No.: 11-034

Supersedes

TN No.: 10-004

Approval Date: 03/05/12

Effective Date: 11/01/2011

MEDICAL ASSISTANCE

State: North Carolina

PAYMENTS FOR MEDICAL AND REMEDIAL CARE AND SERVICE

---

16) Psychosocial Rehabilitation (H2017)

Except as otherwise noted in the plan, state-developed fee schedule rates are the same for both governmental and private providers of Psychosocial Rehabilitation. The agency's fee schedule rate of \$2.74 was set as of October 1, 2009 and is effective for services provided on or after that date. Except as otherwise noted in the plan, this per 15 minute rate shall be adjusted annually using the Medicare Market Basket Index. The fee schedule is published on the agency's website at <http://www.ncdhhs.gov/dma/fee/fee.htm>.

This service will be provided by direct enrolled Medicaid providers who may be either private or governmental. This service is not cost settled for any provider. This service is provided in accordance with Attachment 3.1-A.1 Page 15a.3, Paragraph 13.D., subparagraph (iv).

The facilities providing this service are not IMD facilities and NC Medicaid is not reimbursing room and board for this service.

Notwithstanding any other provision, if specified, these rates will be adjusted as shown on Attachment 4.19-B, Supplement 6 Page 16 section of the State Plan.

---

TN No: 11-034

Supersedes

TN No: NEW

Approval Date: 03/05/12

Effective Date: 11/01/2011

MEDICAL ASSISTANCE

State: North Carolina

PAYMENTS FOR MEDICAL AND REMEDIAL CARE AND SERVICE

---

17) Mobile Crisis Management (H2011)

Except as otherwise noted in the plan, state-developed fee schedule rates are the same for both governmental and private providers of Mobile Crisis Management. The agency's fee schedule rate of \$34.37 was set as of October 1, 2009 and is effective for services provided on or after that date. Except as otherwise noted in the plan, this per 15 minute rate shall be adjusted annually using the Medicare Market Basket Index. The fee schedule is published on the agency's website at <http://www.ncdhhs.gov/dma/fee/fee.htm>.

This service will be provided by direct enrolled Medicaid providers who may be either private or governmental. This service is not cost settled for any provider. This service is provided in accordance with Attachment 3.1-A.1 Page 7c.5a, Paragraph 4.b.(8), subparagraph (f) and Attachment 3.1-A.1 Page 15a.5, Paragraph 13.D., subparagraph (vi).

The facilities providing this service are not IMD facilities and NC Medicaid is not reimbursing room and board for this service.

Notwithstanding any other provision, if specified, these rates will be adjusted as shown on Attachment 4.19-B, Supplement 6 Page 17 section of the State Plan.

---

TN No: 11-034

Supersedes

TN No: NEW

Approval Date: 03/05/12

Effective Date: 11/01/2011

MEDICAL ASSISTANCE

State: North Carolina

PAYMENTS FOR MEDICAL AND REMEDIAL CARE AND SERVICE

---

18) Community Support Team (H2015HT)

Except as otherwise noted in the plan, state-developed fee schedule rates are the same for both governmental and private providers of Community Support Team. The agency's fee schedule rate of \$14.50 was set as of July 1, 2010 and is effective for services provided on or after that date. Except as otherwise noted in the plan, this per 15 minute rate shall be adjusted annually using the Medicare Market Basket Index. The fee schedule is published on the agency's website at <http://www.ncdhhs.gov/dma/fee/fee.htm>.

This service will be provided by direct enrolled Medicaid providers who may be either private or governmental. This service is not cost settled for any provider. This service is provided in accordance with Attachment 3.1-A.1 Page 15a.6, Paragraph 13.d., subparagraph (vii).

The facilities providing this service are not IMD facilities and NC Medicaid is not reimbursing room and board for this service.

Notwithstanding any other provision, if specified, these rates will be adjusted as shown on Attachment 4.19-B, Supplement 6 Page 18 section of the State Plan.

---

TN No: 11-034

Supersedes

TN No: NEW

Approval Date: 03/05/12

Effective Date: 11/01/2011

MEDICAL ASSISTANCE

State: North Carolina

PAYMENTS FOR MEDICAL AND REMEDIAL CARE AND SERVICE

---

19) Child and Adolescent Day Treatment (H2012 HA)

Except as otherwise noted in the plan, state-developed fee schedule rates are the same for both governmental and private providers of Child and Adolescent Day Treatment. The agency's fee schedule rate of \$31.41 was set as of October 1, 2009 and is effective for services provided on or after that date. Except as otherwise noted in the plan, this per 1 hour rate shall be adjusted annually using the Medicare Market Basket Index. The fee schedule is published on the agency's website at <http://www.ncdhhs.gov/dma/fee/fee.htm>.

This service will be provided by direct enrolled Medicaid providers who may be either private or governmental. This service is not cost settled for any provider. This service is provided in accordance with Attachment 3.1-A.1 Page 7c.4, Paragraph 4.b, subparagraph (d).

The facilities providing this service are not IMD facilities and NC Medicaid is not reimbursing room and board for this service.

Notwithstanding any other provision, if specified, these rates will be adjusted as shown on Attachment 4.19-B, Supplement 6 Page 19 section of the State Plan.

---

TN No: 11-034

Supersedes

TN No: NEW

Approval Date: 03/05/12

Effective Date: 11/01/2011

MEDICAL ASSISTANCE

State: North Carolina

PAYMENTS FOR MEDICAL AND REMEDIAL CARE AND SERVICE

---

20) High Risk Intervention – Level I (H0046)

Except as otherwise noted in the plan, state-developed fee schedule rates are the same for both governmental and private providers of High Risk Intervention – Level I. The agency's fee schedule rate of \$50.77 was set as of October 1, 2009 and is effective for services provided on or after that date. Except as otherwise noted in the plan, this per diem rate shall be adjusted annually using the Medicare Market Basket Index. The fee schedule is published on the agency's website at <http://www.ncdhhs.gov/dma/fee/fee.htm>.

This service will be provided by direct enrolled Medicaid providers who may be either private or governmental. This service is not cost settled for any provider. This service is provided in accordance with Attachment 3.1-A.1 Page 15a.19 Paragraph C.

The facilities providing this service are not IMD facilities and NC Medicaid is not reimbursing room and board for this service.

Notwithstanding any other provision, if specified, these rates will be adjusted as shown on Attachment 4.19-B, Supplement 6 Page 20 section of the State Plan.

---

TN No: 11-034

Supersedes

TN No: NEW

Approval Date: 03/05/12

Effective Date: 11/01/2011

MEDICAL ASSISTANCE

State: North Carolina

PAYMENTS FOR MEDICAL AND REMEDIAL CARE AND SERVICE

---

21) High Risk Intervention – Level II Group Home (H2020)

Except as otherwise noted in the plan, state-developed fee schedule rates are the same for both governmental and private providers of High Risk Intervention – Level II Group Home. The agency's fee schedule rate of \$128.89 was set as of October 1, 2009 and is effective for services provided on or after that date. Except as otherwise noted in the plan, this per diem rate shall be adjusted annually using the Medicare Market Basket Index. The fee schedule is published on the agency's website at <http://www.ncdhhs.gov/dma/fee/fee.htm>.

This service will be provided by direct enrolled Medicaid providers who may be either private or governmental. This service is not cost settled for any provider. This service is provided in accordance with Attachment 3.1-A.1 Page 15a.19 Paragraph C.

The facilities providing this service are not IMD facilities and NC Medicaid is not reimbursing room and board for this service.

Notwithstanding any other provision, if specified, these rates will be adjusted as shown on Attachment 4.19-B, Supplement 6 Page 21 section of the State Plan.

---

TN No: 11-034

Supersedes

TN No: NEW

Approval Date: 03/05/12

Effective Date: 11/01/2011



MEDICAL ASSISTANCE

State: North Carolina

PAYMENTS FOR MEDICAL AND REMEDIAL CARE AND SERVICE

---

22) High Risk Intervention – Level II Family Setting (S5145)

Except as otherwise noted in the plan, state-developed fee schedule rates are the same for both governmental and private providers of High Risk Intervention – Level II Family Setting. The agency's fee schedule rate of \$90.39 was set as of October 1, 2009 and is effective for services provided on or after that date. Except as otherwise noted in the plan, this per diem rate shall be adjusted annually using the Medicare Market Basket Index. The fee schedule is published on the agency's website at <http://www.ncdhhs.gov/dma/fee/fee.htm>.

This service will be provided by direct enrolled Medicaid providers who may be either private or governmental. This service is not cost settled for any provider. This service is provided in accordance with Attachment 3.1-A.1 Page 15a.19 Paragraph C.

The facilities providing this service are not IMD facilities and NC Medicaid is not reimbursing room and board for this service.

Notwithstanding any other provision, if specified, these rates will be adjusted as shown on Attachment 4.19-B, Supplement 6 Page 22 section of the State Plan.

---

TN No: 11-034

Supersedes

TN No: NEW

Approval Date: 03/05/12

Effective Date: 11/01/2011

MEDICAL ASSISTANCE

State: North Carolina

PAYMENTS FOR MEDICAL AND REMEDIAL CARE AND SERVICE

---

23) High Risk Intervention – Level III – 4 Beds or Less (H0019)

Except as otherwise noted in the plan, state-developed fee schedule rates are the same for both governmental and private providers of High Risk Intervention – Level III – 4 Beds or Less. The agency's fee schedule rate of \$237.63 was set as of October 1, 2009 and is effective for services provided on or after that date. Except as otherwise noted in the plan, this per diem rate shall be adjusted annually using the Medicare Market Basket Index. The fee schedule is published on the agency's website at <http://www.ncdhhs.gov/dma/fee/fee.htm>.

This service will be provided by direct enrolled Medicaid providers who may be either private or governmental. This service is not cost settled for any provider. This service is provided in accordance with Attachment 3.1-A.1 Page 15a.20.

The facilities providing this service are not IMD facilities and NC Medicaid is not reimbursing room and board for this service.

Notwithstanding any other provision, if specified, these rates will be adjusted as shown on Attachment 4.19-B, Supplement 6 Page 23 section of the State Plan.

---

TN No: 11-034

Supersedes

TN No: NEW

Approval Date: 03/05/12

Effective Date: 11/01/2011

MEDICAL ASSISTANCE

State: North Carolina

PAYMENTS FOR MEDICAL AND REMEDIAL CARE AND SERVICE

---

24) High Risk Intervention – Level III – 5 Beds or More (H0019)

Except as otherwise noted in the plan, state-developed fee schedule rates are the same for both governmental and private providers of High Risk Intervention – Level III – 5 Beds or More. The agency's fee schedule rate of \$193.62 was set as of October 1, 2009 and is effective for services provided on or after that date. Except as otherwise noted in the plan, this per diem rate shall be adjusted annually using the Medicare Market Basket Index. The fee schedule is published on the agency's website at <http://www.ncdhhs.gov/dma/fee/fee.htm>.

This service will be provided by direct enrolled Medicaid providers who may be either private or governmental. This service is not cost settled for any provider. This service is provided in accordance with Attachment 3.1-A.1 Page 15a.20.

The facilities providing this service are not IMD facilities and NC Medicaid is not reimbursing room and board for this service.

Notwithstanding any other provision, if specified, these rates will be adjusted as shown on Attachment 4.19-B, Supplement 6 Page 24 section of the State Plan.

---

TN No: 11-034

Supersedes

TN No: NEW

Approval Date: 03/05/12

Effective Date: 11/01/2011

MEDICAL ASSISTANCE

State: North Carolina

PAYMENTS FOR MEDICAL AND REMEDIAL CARE AND SERVICE

---

25) High Risk Intervention – Level IV (H0019)

Except as otherwise noted in the plan, state-developed fee schedule rates are the same for both governmental and private providers of High Risk Intervention – Level IV. The agency's fee schedule rate of \$322.15 was set as of October 1, 2009 and is effective for services provided on or after that date. Except as otherwise noted in the plan, this per diem rate shall be adjusted annually using the Medicare Market Basket Index. The fee schedule is published on the agency's website at <http://www.ncdhhs.gov/dma/fee/fee.htm>.

This service will be provided by direct enrolled Medicaid providers who may be either private or governmental. This service is not cost settled for any provider. This service is provided in accordance with Attachment 3.1-A.1 Page 15a.20.

The facilities providing this service are not IMD facilities and NC Medicaid is not reimbursing room and board for this service.

Notwithstanding any other provision, if specified, these rates will be adjusted as shown on Attachment 4.19-B, Supplement 6 Page 25 section of the State Plan.

---

TN No: 11-034

Supersedes

TN No: NEW

Approval Date: 03/05/12

Effective Date: 11/01/2011

MEDICAL ASSISTANCE

State: North Carolina

PAYMENTS FOR MEDICAL AND REMEDIAL CARE AND SERVICE

---

26) Alcohol and/or drug services; group counseling by a clinician (H0005)

Except as otherwise noted in the plan, state-developed fee schedule rates are the same for both governmental and private providers of Alcohol and/or drug services; group counseling by a clinician. The agency's fee schedule rate of \$7.45 was set as of October 1, 2009 and is effective for services provided on or after that date. Except as otherwise noted in the plan, this per 15 minute rate shall be adjusted annually using the Medicare Market Basket Index. The fee schedule is published on the agency's website at <http://www.ncdhhs.gov/dma/fee/fee.htm>.

This service will be provided by direct enrolled Medicaid providers who may be either private or governmental. This service is not cost settled for any provider. This service is provided in accordance with Attachment 3.1-A.1 Page 15a.16, Paragraph 13.D, subparagraph 3.

The facilities providing this service are not IMD facilities and NC Medicaid is not reimbursing room and board for this service.

Notwithstanding any other provision, if specified, these rates will be adjusted as shown on Attachment 4.19-B, Supplement 6 Page 26 section of the State Plan.

---

TN No: 11-034

Supersedes

TN No: NEW

Approval Date: 03/05/12

Effective Date: 11/01/2011

MEDICAL ASSISTANCE

State: North Carolina

PAYMENTS FOR MEDICAL AND REMEDIAL CARE AND SERVICE

---

27) Behavioral health counseling and therapy (H0004)

Except as otherwise noted in the plan, state-developed fee schedule rates are the same for both governmental and private providers of Behavioral health counseling and therapy. The agency's fee schedule rate of \$20.21 and \$7.45 for group was set as of October 1, 2009 and is effective for services provided on or after that date. Except as otherwise noted in the plan, this 15 minute rate shall be adjusted annually using the Medicare Market Basket Index. The fee schedule is published on the agency's website at <http://www.ncdhhs.gov/dma/fee/fee.htm>.

This service will be provided by direct enrolled Medicaid providers who may be either private or governmental. This service is not cost settled for any provider. This service is provided in accordance with Attachment 3.1-A.1 Page 15a.16, Paragraph 13.D, subparagraph 3.

The facilities providing this service are not IMD facilities and NC Medicaid is not reimbursing room and board for this service.

Notwithstanding any other provision, if specified, these rates will be adjusted as shown on Attachment 4.19-B, Supplement 6 Page 27 section of the State Plan.

---

TN No: 11-034

Supersedes

TN No: NEW

Approval Date: 03/05/12

Effective Date: 11/01/2011

MEDICAL ASSISTANCE

State: North Carolina

PAYMENTS FOR MEDICAL AND REMEDIAL CARE AND SERVICE

---

28) Mental Health Assessment (H0031)

Except as otherwise noted in the plan, state-developed fee schedule rates are the same for both governmental and private providers of Mental Health Assessment. The agency's fee schedule rate of \$20.21 was set as of October 1, 2009 and is effective for services provided on or after that date. Except as otherwise noted in the plan, this per 15 minute rate shall be adjusted annually using the Medicare Market Basket Index. The fee schedule is published on the agency's website at <http://www.ncdhhs.gov/dma/fee/fee.htm>.

This service will be provided by direct enrolled Medicaid providers who may be either private or governmental. This service is not cost settled for any provider. This service is provided in accordance with Attachment 3.1-A.1 Page 15a.16, Paragraph 13.D, subparagraph 3.

The facilities providing this service are not IMD facilities and NC Medicaid is not reimbursing room and board for this service.

Notwithstanding any other provision, if specified, these rates will be adjusted as shown on Attachment 4.19-B, Supplement 6 Page 28 section of the State Plan.

---

TN No: 11-034

Supersedes

TN No: NEW

Approval Date: 03/05/12

Effective Date: 11/01/2011

MEDICAL ASSISTANCE  
State: NORTH CAROLINA

PAYMENTS FOR MEDICAL AND REMEDIAL CARE AND SERVICE

---

14. Services for individuals age 65 or older in institutions for mental diseases.

a. Inpatient Hospital Services.

Described in Attachment 4.19-A and Attachment 3.1-A.1, page 15b.



MEDICAL ASSISTANCE  
State NORTH CAROLINA

PAYMENTS FOR MEDICAL AND REMEDIAL CARE AND SERVICE

---

14. Services for individuals age 65 or older in institutions for mental diseases.
- C. Intermediate care facility services.  
Described in Attachment 4.19-D.

---

TN No. 88-12  
SUPERSEDES  
TN No. NEW

DATE RECEIPT 9/21/88  
DATE APPROVED 6/9/89  
DATE EFFECTIVE 7/1/89

MEDICAL ASSISTANCE  
State NORTH CAROLINA

PAYMENTS FOR MEDICAL AND REMEDIAL CARE AND SERVICE

- 15.a. Intermediate care facility services (other than such services in an institution for mental diseases) for persons determined, in accordance with section 1902(a)(31)(A) of the Act, to be in need of such care.

Described in Attachment 4.19-D.

---

TN No. 88-12  
SUPERSEDES  
TN NO. NEW

DATE RECEIPT 9/21/88  
DATE APPROVED 6/9/89  
DATE/EFFECTIVE 7/1/88

MXDICAL ASSISTANCE  
State NORTH CAROLINA

PAYMENTS FOR MEDICAL AND REMEDIAL CARE AND SERVICE

---

15. Intermediate care facility services (other than such services in an institution for mental diseases) for persons determined, in accordance with section 1902(a)(31)(A) of the Act, to be in need of such care.
  - b. Including such services in a public institution (or distinct part thereof for the mentally retarded or persons with related conditions.

Described in Attachment 4.19-D Addendum ICF-MR.

---

TN No. 88-12  
SUPERSEDES  
TN No. NEW

DATE RECEIPT 9/21/88  
DATE APPROVED 6/9/89  
DATE EFFECTIVE 7/1/89

MEDICAL ASSISTANCE  
State NORTH CAROLINA

PAYMENTS FOR MEDICAL AND REMEDIAL CARE AND SERVICE

---

16. Inpatient psychiatric facility services for individuals under 21 years of age.  
Described in Attachment 4.19-A, Page 32 and Attachment 3.1-A.1, page 17.

State Plan Under Title XIX of the Social Security Act  
Medical Assistance  
State NORTH CAROLINA

PAYMENTS FOR MEDICAL AND REMEDIAL CARE AND SERVICE

=====

17. A. Nurse-Midwife Services.

Payments for Nurse-Midwife Services covered under Attachment 3.1-A.1 are equal to the lower of the submitted charge or the appropriate fee from the North Carolina Medicaid Nurse-Midwife Services Fee Schedule.

The agency's rates were set as of November 1, 2011 and are effective on or after that date. Rates for Nurse-Midwife Services are adjusted annually in accordance with the physician services fee schedule. All rates are published on the website at <http://www.ncdhhs.gov/dma/fee/index.htm>. Except as otherwise noted in the plan, State developed fee schedule rates are the same for both governmental and private providers.

(a) Effective November 1, 2011 Nurse-Midwife Services rates shall be set at 97.33% percent of North Carolinas' Medicaid Physician Services Fee Schedule in effect on October 1 of 2009. Effective July 1, 2012 Nurse-Midwife Services rates shall be set at 98% percent of North Carolinas' Medicaid Physician Services Fee Schedule in effect on October 1 of 2009.

(b) Notwithstanding any other provision, if specified, these rates will be adjusted as shown on Attachment 4.19B, Supplement 3, Page 1x of the State Plan.

(2) Enhanced Payments for Pregnancy Medical Home Services will be made to licensed nurse midwives for services provided by a Pregnancy Medical Home provider as specified in Attachment 3.1-B, Page 7(a) and Attachment 3.1-F. Reimbursement will be as described in Attachment 4.19-B Section 5, Page 4 of the State Plan. There shall be no cost settlement for any provider in any setting for these services reimbursed at the enhanced rates.

State Plan Under Title XIX of the Social Security Act  
Medical Assistance  
State NORTH CAROLINA

PAYMENTS FOR MEDICAL AND REMEDIAL CARE AND SERVICE

=====

B. Certified Registered Nurse Anesthetists Services (CRNA's).

Payments for Certified Registered Nurse Anesthetist Services covered under Attachment 3.1-A.1 are equal to the lower of the submitted charge or the appropriate fee from the North Carolina Medicaid CRNA Fee Schedule. Rates are adjusted annually in accordance with the physician services fee schedule.

The agency's rates were set as of November 1, 2011 and are effective on or after that date. All rates are published on the website at <http://www.ncdhhs.gov/dma/fee/index.htm>. Except as otherwise noted in the plan, State developed fee schedule rates are the same for both governmental and private providers.

(a) Effective November 1, 2011 CRNA's rates shall be set at 97.33% percent of North Carolinas' Medicaid Physician Services Fee Schedule in effect on October 1 of 2009. Effective July 1, 2012 CRNA's rates shall be set at 98% percent of North Carolinas' Medicaid Physician Services Fee Schedule in effect on October 1 of 2009.

(b) Notwithstanding any other provision if specified, these rates will be adjusted as shown on Attachment 4.19-B, Supplement 1, Page 1e of the State Plan.

C. Anesthesiologist Assistant Services.

Effective, October 1, 2008, fees for anesthesiologist assistants (AAs) are established at 50% of Anesthesiologist rates for DMA approved procedures (CPT and HCPCS). Anesthesiologists are reimbursed the same as physician services, which are based on the current Medicaid Physician Fee Schedule. Covered Medicaid services are described in Attachment 3.1-A.1.

The Division of Medical Assistance rates were set as of October 1, 2008 and are effective on or after that date. All rates are published on the agency's website, <http://www.ncdhhs.gov/dma/fee/fee.htm>. Except as otherwise noted in the plan, State developed fee schedule rates are the same for both governmental and private providers.

In subsequent years, these rates will be adjusted as the Anesthesiologists rates are adjusted. Notwithstanding any other provision if specified, these rates will be adjusted as shown on Attachment 4.19-B, Supplement 3, Page 1x of the State Plan.

State Plan Under Title XIX of the Social Security Act  
Medical Assistance Program  
State: North Carolina

---

Payments for Medical and Remedial Care and Services

---

18. Hospice Care (in accordance with section 1905(o) of the Act).

Hospice services are paid using the annual, federal Medicaid hospice payment rates. These federal rates are based on the methodology used in setting Medicare reimbursement rates adjusted to remove offsets for the Medicare co-insurance amounts, and with the following exceptions:

- There is no limit on overall aggregate payments made to a hospice agency by Medicaid.
- Payments to a hospice for inpatient care are limited in relation to all Medicaid payments to the agency for Hospice care. During the twelve month period beginning November 1 of each year and ending October 31, the aggregate number of inpatient days, inpatient respite and general inpatient, may not exceed 20 percent of the aggregate total number of days of Hospice care provided during the same time period for all the hospice's Medicaid patients. Hospice care provided for patients with acquired immune deficiency syndrome (AIDS) is excluded in calculating the inpatient care limit. The hospice refunds any overpayments to Medicaid.
- A hospice may be paid 95 percent of the long term care (SNF/ICF) room and board rate, in addition to the home care rate, for a nursing facility resident's Hospice care. The nursing facility may not bill Medicaid for the individual's care that duplicates Hospice Services.
- Notwithstanding any other provision, if specified, these rates will be adjusted as shown on Attachment 4.19-B, Supplement 2, Page 1e of the State Plan.

State Plan Under Title XIX of the Social Security Act  
Medical Assistance Program  
State: North Carolina

Payments for Medical and Remedial Care and Services

---

19. Case Management Services as defined in, and to the group specified in, Supplement 1 to ATTACHMENT 3.1-A (in accordance with section 1905(a)(19) or section 1915(g) of the Act).

PAGE INTENTIONALLY LEFT BLANK

---

TN No. 10-035A  
Supersedes  
TN No. 10-020

Approval Date: 03-21-11

Effective Date: 03/01/2011



State Plan Under Title XIX of the Social Security Act  
Medical Assistance Program  
State: North Carolina

---

Payments for Medical and Remedial Care and Services

---

B. Targeted Case Management for Adults and Children At-Risk For Abuse, Neglect, or Exploitation (ARCM):

The rate for Targeted Case Management for Adults and Children at Risk for Abuse, Neglect, or Exploitation was established based on data acquired during the Cost Reconciliation Process. The Division of Medical Assistance (DMA) uses the Cost per hour Calculation defined in section ii (d) to determine the interim rate. The Cost per hour rate for each local county DSS is averaged and multiplied by 90% to determine if the interim rate requires adjusting.

Except as otherwise noted in the plan, state-developed fee schedule rates are the same for both governmental and private providers of Targeted Case Management for Adults and Children At-Risk For Abuse, Neglect, or Exploitation. The agency's fee schedule rate of \$13.22 was set as of October 1, 2009 and is effective for services provided on or after that date.

Except as otherwise noted in the plan, this per 15 minute rate shall be adjusted annually by the Medicare Market Basket Index. The fee schedule is published on the agency's website at <http://www.ncdhhs.gov/dma/fee/fee.htm>. Notwithstanding any other provision, if specified, these rates will be adjusted as shown on Attachment 4.19-B, Supplement 5, Page 1 of the State Plan.

This service will be provided by direct enrolled Medicaid providers who may be either private or governmental. Medicaid Governmental services are reimbursed at cost through cost settlement.

**Private Providers:**

Private providers are reimbursed the lesser of the billed amount or fee schedule amount. The rate for private providers' is not subject to final settlement reconciliation.

**Governmental Providers:**

Medicaid Governmental Providers are paid at cost.

The interim rate for governmental providers is subject to final settlement reconciliation to actual cost. Each local county DSS provider must prepare and submit a report of its costs and other financial information related to reimbursement annually. The year to date report must include costs from a fiscal period beginning on July 1 and ending on June 30.

Each local county DSS provider must certify the total computable cost of service payments and submit the Certified Public Expenditure (CPE) Attestation form to DMA.

State Plan Under Title XIX of the Social Security Act  
Medical Assistance Program  
State: North Carolina

---

Payments for Medical and Remedial Care and Services

---

**The Cost Report Process**

To determine the Medicaid-allowable direct and indirect costs of providing Medicaid-eligible at-risk case management (ARCM) services for local county Department of Social Services, the following process is performed:

- (1) Accumulate direct costs for ARCM services which include payroll costs that can be directly charged to direct services.

These direct costs are accumulated on the provider's cost distribution report (XS325) utilizing a direct services time equivalency system. (The equivalency system serves as the basis to allocate non-direct personnel costs and overhead to each program.) The provider's XS325 report contains the scope of cost and methods of cost allocation in accordance with the principles in 2 CFR Part 225 and the CMS Provider Reimbursement Manual.

---

TN No. 11-007  
Supersedes  
TN No. NEW

Approval Date: 09-12-14

Effective Date: 03/01/2011

State Plan Under Title XIX of the Social Security Act  
Medical Assistance Program  
State: North Carolina

Payments for Medical and Remedial Care and Services

The ARCM time equivalency (FTE) is a percentage of total minutes charged to ARCM (service code 395, program code 2) on day sheets completed by each direct service employee to total time spent in direct activities for the month utilizing the local county Division of Social Services' (DSS) time recording system. See Table 1 for an example:

Table 1

Program	Service Code/Program Code	Minutes	Time Equivalency (FTE)	County Use
SSBG	X	2,000	.25	01/09
Non-DSS Reimbursement	N	2,000	.25	32/18
Medicaid CMS (ARCM)	395/2	4,000	.50	09/18
Direct Time Total		8,000	1.00	
General Administration		1,600		
Worker Total		9,600		

The direct time FTEs from the day sheets are accumulated for each direct service employee at the end of each month on the Percentages of Time By Program and Service Worker Report and assigned a function code and column code (County Use column on Table 1). The purpose of assigning a function code/column code is to identify the specific service program to allocate the FTE and salary and benefits on the DSS-1571. The function code/column code for ARCM is 09/18. The information is then entered into the DSS-1571 system to generate the Detailed Average Percentage of Time By Employee report (TEC report) which details FTE and salary and benefits cost by employee by program. The ARCM FTE and salary and benefits costs coded to 09/18 are totaled and applied to Part 1A of the XS325, under application code 286 Non Reim Med CMS (the line item on the report specifically for ARCM FTE and costs). The resulting total FTE and salary and benefits cost are the ARCM program's direct costs.

- (2) Distribute direct service support costs and indirect costs to each program based on the program's direct service FTE and salary and benefits costs described in (1) above. The distribution is performed in five specific sequential stages on the XS325 as follows:
  - a) Support A Overhead (cost pool expenses charged to the service programs) and Support A Super 84 costs (salary costs for supervisory and clerical staff providing services to service programs) are allocated to the service programs in Part 1A (Services) of the XS325 based on accumulated direct service FTE. The ARCM program FTE and costs are included in Part 1A. (Likewise, Support B and Support C costs are distributed to Part 1B (Income Maintenance) and 1C (IV-D), respectively. These allocations have no impact on the ARCM costs.)

State Plan Under Title XIX of the Social Security Act  
Medical Assistance Program  
State: North Carolina

---

Payments for Medical and Remedial Care and Services

---

- b) Support J costs (joint worker costs) are allocated to all programs in Parts 1A, 1B and 1C based on the percentage of total direct staff FTE in each program (sum of time equivalency from (1) above and (2a) above) to total staff FTE in the agency. This is the second distribution.
  - c) Administrative costs (staff costs rendering agency level support such as the Administrative Assistant, Clerical, and Director not directly charged) and FTE are distributed to all agency programs based on each program's accumulated FTE (sum of the program's FTE from (1), (2a), and (2b) above) to total agency staff FTE. This is the third distribution.
  - d) 311 Indirect Administrative costs (capital outlay equipment, building depreciation from the county's indirect cost allocation plan) are distributed to each program in proportion to the program's accumulated FTE (sum of FTE from (1), (2a), (2b) and (2c) above) to total agency FTE. This is the fourth distribution.
  - e) Non-matchable costs (non-reimbursable costs such as sales tax, tips, and reimbursable items from other sources) are removed into its own category. This is the final distribution. (This distribution has no impact on the ARCM program costs.)
- (3) Determine the cost settlement based on the total accumulated time equivalency and salary and benefits charged to the ARCM program.

ii. **The Cost Reconciliation Process**

a. **Units and Dollars Paid**

A report of the interim payments and units for the cost settlement period is produced by the Medicaid Fiscal Agent for each local county DSS provider.

b. **Minutes Report**

DMA receives a time equivalency report separated by county from the Division of Planning & Evaluation NC DHHS Division of Social Services for the previous SFY. This report includes minutes coded to Program 2 (Medicaid Case Management) for service 395 (At Risk case Management Services).

State Plan Under Title XIX of the Social Security Act  
Medical Assistance Program  
State: North Carolina

---

Payments for Medical and Remedial Care and Services

---

c. **Cost Allocation Report**

The Division of Medical Assistance receives each month two county cost allocation reports WC370FY and WC370MON from the DHHS Controllers Office detailing each county costs for the ARCM program. These reports are based on dates of service June – May requiring the reports be converted to SFY dates of service.

d. **Cost per hour Calculation**

The cost per hour calculation is determined by using the minutes report and converting the minutes to hours by dividing the minutes by 60. The total SFY cost (from the Cost Allocation Report) is divided by the minutes (converted to hours) to calculate cost per hour.

e. **Cost Reconciliation Calculation for Each Local County DSS Agency**

The Cost Settlement is calculated by taking the units paid from the data drive run and converting them to hours by dividing them by 4. Using the cost per hour calculation derived in paragraph d. above, multiply the cost per hour by the units converted to hours to determine the total provider cost to run this service. Multiply the total provider cost by the FFP at the time of payment to determine the federal portion of the provider cost. The Settlement result is determined by subtracting the federal portion of the provider cost from the amount paid to the provider.

**ii. The Cost Settlement Process**

If local county DSS interim payments exceed their certified cost for providing Targeted Case Management for Children At-Risk For Abuse, Neglect, or Exploitation to Medicaid recipients, the local county DSS provider will remit the federal share of the overpayment. If a local county DSS provider's certified cost exceeds their interim payments for providing the service to Medicaid recipients, the local county DSS provider will be reimbursed the difference.

The payment methodology, cost report, cost reconciliation, and cost settlement processes for Targeted Case Management Services for Adults and Children At-risk of Abuse, Neglect or Exploitation as outlined in the above pages end on June 30, 2014.

---

TN No: 11-007  
Supersedes  
TN No: NEW

Approval Date: 09-12-14

Effective Date: 03/01/2011

State Plan Under Title XIX of the Social Security Act  
Medical Assistance Program  
State: North Carolina

---

Payments for Medical and Remedial Care and Services

---

C. Targeted Case Management Services: Adults and Children Over 5 Years of Age, or On the CAP-MR/DD Waiver, With Developmental Disabilities Or Traumatic Brain Injury:

Except as otherwise noted in the plan, state-developed fee schedule rates are the same for both governmental and private providers of Targeted Case Management Services for Children and Adults with Developmental Disabilities/Delay or Traumatic Brain Injury, Manifested Prior to Age 22. The agency's fee schedule rate of \$62.26 per week was set as of July 1, 2010 and is effective for services provided on or after July 1, 2010 and is inflated forward by the Medicare Market Basket Index annually on July 1<sup>st</sup>. The fee schedule is published on the agency's website at <http://www.ncdhhs.gov/dma/fee/fee.htm>.

This service will be provided by direct enrolled Medicaid providers who may be either private or public.

The case rate was developed using the MR/DD historical data containing fee for service claims data for T1017 HI from July 2006 through June 2009. An actuarially determined rate range was provided to the agency and a rate within this range was selected.

This service is not cost settled for any provider.

Notwithstanding any other provision, if specified, these rates will be adjusted as shown on Attachment 4.19-B, Supplement 5, Page 2 section of the State Plan.

---

TN No. 13-017  
Supersedes  
TN No. 11-022

Approval Date: 12-08-14

Effective Date: 08/01/2013

State Plan Under Title XIX of the Social Security Act  
Medical Assistance Program  
State: North Carolina

---

Payments for Medical and Remedial Care and Services

---

D. TARGETED CASE MANAGEMENT SERVICES

*Children Less Than Three Years of Age Who Are At Risk For, or Have Been Diagnosed With, Developmental Delay/Disability or Social Emotional Disorder*

Target Group (42 Code of Federal Regulations 441.18(8)(i) and 441.18(9)):

This target group includes the individuals who meet the requirements defined in the Children's Development Service Agencies' policy: Children less than three years of age who are at risk for, or have been diagnosed with, developmental delay/disability or social emotional disorder.

North Carolina reimburses governmental providers, Child Development Services Agencies, actual costs for the provision of this 15 minute unit of targeted case management.

Annually, governmental providers are paid actual costs and are reconciled through a cost report submitted by the governmental providers as detailed in Attachment 4.19-B, Section 9, page 1 of the state plan.

Payment methodology for this service will end date on October 31, 2011.

State Plan Under Title XIX of the Social Security Act  
Medical Assistance Program  
State: North Carolina

---

Payments for Medical and Remedial Care and Services

---

C. Targeted Case Management for Persons with HIV Disease.

Except as otherwise noted in the plan, state-developed fee schedule rate is the same for both governmental and private providers of Targeted Case Management Services for Persons with HIV Disease. The agency's fee schedule rate of \$13.22 was set as of July 1, 2010 and is effective for services provided on or after that date. Except as otherwise noted in the plan, this per unit rate (one unit equals fifteen minutes) shall be inflated forward by the Medicare Market Basket Index annually. Providers will be reimbursed the lower of the fee schedule rate or their usual and customary charge.

The Fee schedule is published on the agency's website at  
<http://www.ncdhhs.gov/dma/fee/fee.htm>.

This service will be provided by direct enrolled Medicaid providers who may be either governmental or private providers. Notwithstanding any other provision, if specified, these rates will be adjusted as shown on Attachment 4.19-B, Supplement 5, Page 3 section of the State Plan.

This service is not cost settled for any provider.

---

TN No. 11-028  
Supersedes  
TN No. 10-021

Approval Date: 10-20-11

Effective Date: 11/01/2011



State Plan Under Title XIX of the Social Security Act  
Medical Assistance Program  
State: North Carolina

---

Payments for Medical and Remedial Care and Services

---

E. Targeted Case Management For Children And Adults With Serious Emotional Disturbance, Or Severe And Persistent Mental Illness Or Substance Abuse Disorder (MH/SA-TCM)

Except as otherwise noted in the plan, state-developed fee schedule rates are the same for both governmental and private providers of Targeted Case Management For Children And Adults With Serious Emotional Disturbance, Or Severe And Persistent Mental Illness Or Substance Abuse Disorder (MH/SA-TCM) . The agency's fee schedule rate of \$81.25 per week was set as of July 1, 2010 and is effective for services provided on or after July 1, 2010 and is inflated forward by the Medicare Market Basket Index annually on July 1st. The fee schedule is published on the agency's website at <http://www.ncdhhs.gov/dma/fee/fee.htm>.

This service will be provided by Critical Access Behavioral Health Agencies (CABHA) (as specified in Attachment 3.1-A.1, Page 7c.1a and Attachment 3.1-A.1, Page 15a, 13.d) enrolled in Medicaid that may be either private or public.

The case rate was developed using the MR/DD historical data containing fee for service claims data for T1017 HI from July 2006 through June 2009. An actuarially determined rate range was provided to the agency and a rate within this range was selected.

This service is not cost settled for any provider.

Notwithstanding any other provision, if specified, this rate will be adjusted as shown on Attachment 4.19-B, Supplement 5 Page 3 section of the State Plan.

---

TN No: 13-016  
Supersedes  
TN No. 11-030

Approval Date: 12-11-14

Effective Date: 8/1/2013

MEDICAL ASSISTANCE  
State: NORTH CAROLINA

PAYMENTS FOR MEDICAL AND REMEDIAL CARE AND SERVICE

---

---

20. Extended services to pregnant women.
- a.) Pregnancy related and postpartum services through the end of the month in which the 60-day period (beginning on the last day of her pregnancy) ends: and
  - b.) Services for any other medical conditions that may complicate pregnancy.

The fee paid to private providers for childbirth classes was established based on the current community practice. The fee paid to providers for child birth classes is \$9.55 per hour. The maximum reimbursement per series of 10 hours per client pregnancy is \$95.50 for all providers. This rate will be evaluated annually. Notwithstanding any other provision, if specified these rates will be adjusted as shown on Supplement 1, Page 3 to the Attachment 4.19-B section of the state plan

Except as otherwise noted in the plan, state developed fee schedule rates are the same for both governmental and private providers of childbirth education and the fee schedule and any annual/periodic adjustments to the fee schedule are published on [www.ncdhhs.gov/dma/fee](http://www.ncdhhs.gov/dma/fee).

Reimbursement to public agencies determined to be in excess of cost will be recouped by means of cost settlement. The agency's fee schedule rate was set as of October 1, 2002 and is effective for services provided on or after that date. All rates are published on the agency's website.

---

TN No.: 09-021  
Supersedes  
TN No.: 07-004

Approval Date: 01-14-10

Effective Date: 07/01/2009

MEDICAL ASSISTANCE  
State: NORTH CAROLINA

PAYMENTS FOR MEDICAL AND REMEDIAL CARE AND SERVICES

---

23. Any other medical care and any other type of remedial care recognized under State law, specified by the Secretary.

a. Transportation

1. AMBULANCE-

Ambulance Transportation services are medically necessary when provided by an ambulance provider under the Medicaid program in accordance with the following as described in Attachment 3.1-A.1, paragraph 23a.

Payment to private providers will be set as a percentage of the Medicare Fee Schedule in effect as of January 1 of each year. The percentages will be applied as indicated in paragraph 23 (A). Interim payment to governmental providers will be set at the same level as private providers and will be cost reconciled to equal the cost of services provided during the fiscal period beginning July 1, 2009 through June 30, 2010, and for subsequent 12 month fiscal periods. Cost will be determined by the Division of Medical Assistance using a CMS approved cost identification process in accordance with 2 CFR Part 225 and the CMS Provider Reimbursement Manual. Cost for each governmental provider will be identified and compared to the interim payment, based on this comparison, additional payment or recovery of payment will be made to assure that the total of payment equals cost. Governmental and private ambulance transportation providers' interim rates are listed on Page 1a.

MEDICAL ASSISTANCE  
State: NORTH CAROLINA

PAYMENTS FOR MEDICAL AND REMEDIAL CARE AND SERVICES

---

---

A. Direct Medical Services Payment Methodology

Effective July 1, 2009 Ambulance Services fees will be based on the following percentages of the Medicare Fee Schedule:

- a. Ground Mileage, Per Statue Mile will be 45%
- b. Advanced Life Support, Non-Emergency, Level 1 will be 30%
- c. Basic Life Support, Non-Emergency, Level 1 will be 33%
- d. Advanced Life Support, Emergency will be 35%
- e. Basic Life Support, Emergency will be 22%
- f. Conventional Air Services, One Way (Fixed Wing) will be 16%
- g. Conventional Air Services, One Way (Rotary Wing) will be 14%
- h. Advance Life Support, Level 2 will be 24%
- i. Fixed Wing Air Mileage per Statue Mile will be 45%
- j. Rotary Wing Air Mileage, Per Statue Mile will be 54%

Fee changes for codes not covered by Medicare that Medicaid currently covers, such as Non-Emergency Transportation will be based on the forecasted Gross National Product (GNP) Implicit Price Deflator.

Notwithstanding any other provision, if specified, these rates will be adjusted as shown on Attachment 4.19-B, Supplement 2, Page 1a of the State Plan. These rates will be adjusted July 1<sup>st</sup> of each year.

The Ambulance Transportation Fee Schedule is published on the North Carolina Department of Health and Human Services, Division of Medical Assistance (DMA) Website located at <http://www.ncdhhs.gov/dma/fee/fee.htm>.

---

TN No: 11-025  
Supersedes  
TN No: 09-007

Approval Date: 10-20-11

Eff. Date: 11/01/2011

MEDICAL ASSISTANCE  
State: NORTH CAROLINA

PAYMENTS FOR MEDICAL AND REMEDIAL CARE AND SERVICES

---

B. Direct and Indirect Allowable Cost Methodology

The Division of Medical Assistance (DMA) uses a cost based methodology for governmental Ambulance Transportation providers which consist of a cost report and reconciliation.

---

TN No: 09-007  
Supersedes  
TN No: 07-003

Approval Date: 01-21-10

Eff. Date 07/01/09

MEDICAL ASSISTANCE  
State: NORTH CAROLINA

PAYMENTS FOR MEDICAL AND REMEDIAL CARE AND SERVICES

---

To determine the Medicaid-allowable direct and indirect costs of providing Medicaid-eligible emergency transportation for governmental providers, the following steps are performed:

- (1) Direct costs for direct medical services include payroll costs, EMS service contracted, communications, rental cost equipment/vehicles, EMS travel, vehicle maintenance/operations/repairs; materials and supplies that can be directly charged to direct medical services.

These direct costs are accumulated on the provider's annual cost report, resulting in total direct costs. The cost report contains the scope of cost and methods of cost allocation in accordance with the principles in 2 CFR Part 225 and the CMS Provider Reimbursement Manual.

- (2) Total direct costs for direct medical services from Item B 1 above are reduced on the cost report by any federal grant payments with a matching requirement resulting in adjusted direct costs for direct medical services.
- (3) Indirect costs are determined using the provider's annual central service cost allocation plan. A double step-down allocation requiring sequential ordering of benefiting departments is used to distribute indirect costs among central services and other departments that receive benefits. Only Medicaid-allowable costs are certified by providers. North Carolina adheres to the CMS approved cost identification process described on this page.
- (4) Net direct costs and indirect costs are combined.
- (5) An average cost per trip is calculated by dividing net direct and indirect costs by total transports. Transports are transportation of a patient for medically necessary treatment. Trips are empty ambulance en route to a call or returning from a transport. Mileage is only applied for medically necessary ground transportation outside the county's base area.
- (6) Medicaid's portion is calculated by multiplying the results from Item B 4 above by the total number of Medicaid transports.

---

TN No: 09-007  
Supersedes  
TN No: 07-003

Approval Date: 01-21-10

Eff. Date 07/01/09

MEDICAL ASSISTANCE  
State: NORTH CAROLINA

PAYMENTS FOR MEDICAL AND REMEDIAL CARE AND SERVICES

---

C. Annual Cost Report Process

For Ambulance transportation listed in Paragraph 23a.1 during the state fiscal year, each governmental ambulance provider must complete an annual cost report. The cost report is due on or before November 30<sup>th</sup> following the reporting period.

Providers that fail to fully and accurately complete Medicaid cost reports within the time period specified by the Division of Medical Assistance or that fail to furnish required documentation and disclosures for Medicaid cost reports required under this Plan within the time period specified by the Division, may be subject to withhold penalties for non-compliance. A 20 percent withhold of Medicaid payments will be imposed upon the delinquent provider 30 days after the Medicaid cost report filing deadline unless the provider has made a written request for an extension of the Medicaid cost report filing due date to the Division of Medical Assistance and has received a written approval from the Division of Medical Assistance. The withholding of monies will continue until the Medicaid cost report filing requirements have been satisfied. Once, all requirements have been satisfied withheld monies will be released to the provider. Any monies withheld will not accrue interest to the benefit of the provider.

The primary purposes of the governmental cost report are to:

- (3) Document the provider's total CMS-approved, Medicaid-allowable costs of delivering Medicaid coverable services using a CMS-approved cost allocation methodology
- (4) Reconcile annual interim payments to total CMS-approved, Medicaid - allowable costs using a CMS approved cost allocation methodology.

---

TN No: 09-007  
Supersedes  
TN No: 07-003

Approval Date: 01-21-10

Eff. Date 07/01/09

MEDICAL ASSISTANCE  
State: NORTH CAROLINA

PAYMENTS FOR MEDICAL AND REMEDIAL CARE AND SERVICES

---

D. The Cost Reconciliation Process

The cost reconciliation process must be completed within twelve months of the end of the reporting period covered by the annual Ambulance Transportation Cost Report. The total Medicaid-allowable scope of costs based in accordance with 2 CFR Part 225 and the CMS Provider Reimbursement Manual methodology are compared to the Ambulance Transportation Medicaid interim payments delivered during the reporting period as documented in the Medicaid Management Information System (MMIS), resulting in a cost reconciliation.

For the purposes of cost reconciliation, the state may not modify the 2 CFR Part 225 and the CMS Provider Reimbursement Manual approved scope of costs. Any modification to the scope of cost, cost allocation methodology procedures requires approval from CMS prior to implementation.

---

TN No: 09-007  
Supersedes  
TN No: 07-003

Approval Date: 01-21-10

Eff. Date 07/01/09



MEDICAL ASSISTANCE  
State: NORTH CAROLINA

PAYMENTS FOR MEDICAL AND REMEDIAL CARE AND SERVICES

---

E. The Cost Settlement Process

If a provider's interim payments exceed the provider's certified cost for Ambulance Transportation provided to Medicaid clients, the provider will remit the excess federal share of the overpayment at the time the cost report is submitted. The federal share will be returned via CMS-64 Report.

If the certified cost of an ambulance transportation provider exceeds the interim payments, the Division of Medical Assistance will pay the federal share of the difference to the provider in accordance with the final actual certification agreement and submit claims to the CMS for reimbursement of that payment in the federal fiscal quarter following payment to the provider.

---

TN No: 09-007  
Supersedes  
TN No: 07-003

Approval Date: 01-21-10

Eff. Date 07/01/09

State Plan Under Title XIX of the Social Security Act  
Medical Assistance  
State: NORTH CAROLINA

PAYMENTS FOR MEDICAL AND REMEDIAL CARE AND SERVICES

---

F. Non-Emergency Medical Transportation:

Payments for Non-Emergency Medical Transportation services covered under Attachment 3.1-D provided by Commercial carriers shall be reimbursed at an individually negotiated rate or the prevailing commercial rate. The agency's rates were set as of October 1, 2012.

Mileage costs incurred by recipients and financially responsible persons using their private vehicles, the amount of reimbursement shall not exceed half the current IRS business rate at 27 cents per mile. Mileage cost for volunteers who are persons other than the recipients and financially responsible persons and are using their private vehicles shall be reimbursed at an amount not to exceed the current IRS business rate at 55 cents per mile.

In subsequent years, these rates will be adjusted as the IRS business rates are adjusted.

Reimbursement for related ancillary travel expenses may not exceed the state mileage, subsistence and lodging reimbursement rates. The rates can be found at: <http://www.ncdhhs.gov/dma/fee/index.htm>. The rates for food and lodging are set by the North Carolina Office of State Budget and Management.

Reimbursement for an attendant's transportation time, excluding wait time, shall not exceed the state hourly minimum wage rate of \$7.25 per hour. This rate is established by the North Carolina Office of State Personnel. Medical professionals who bill separately for medical services shall not be reimbursed for time.

Medicaid will make no payment for expenses of an attendant to sit and wait following recipient's admission to a medical facility.

Notwithstanding any other provision, if specified, these rates will be adjusted as shown on Attachment 4.19B, Supplement 2, Page 1f of the State Plan.

There shall be no cost settlement for these services.

MEDICAL ASSISTANCE  
State NORTH CAROLINA

PAYMENTS FOR MEDICAL AND REMEDIAL CARE AND SERVICE

---

23. Any other medical care and any other type of remedial care recognized under State law, specified by, the Secretary.
- d. Skilled nursing facility services for patients under 21 years age.  
Described in Attachment 4.19-D.

MEDICAL ASSISTANCE  
STATE NORTH CAROLINA

PAYMENTS FOR MEDICAL AND REMEDIAL CARE AND SERVICES

---

23. Any other Medical Care and any other type of remedial care recognized under State law, specified by the Secretary.

PERSONAL CARE SERVICES

Personal Care Services are reimbursed under the authority of 42 CFR 440.167 and when provided as defined in Attachment 3.1-A.1, Page 19, of this State Plan.

Effective October 1, 2013, payment for Personal Care Services (PCS) shall be reimbursed to providers, who are allowed to bill PCS in fifteen (15) minute increments of care at a rate of \$3.58 per unit. The agency's fee schedule rate is based upon historical cost data collected from the provider community. This rate will be a prospective rate and shall not be subject to any cost settlements.

Except as otherwise noted in the plan, the state-developed fee schedule rate is the same for both governmental and non-governmental providers of Personal Care Services. This rate is published at <http://www.ncdhhs.gov/dma/fee/index.htm>. Subsequent to the initial effective date of the Personal Care Services rate, this rate shall be adjusted annually using the Medicare Home Health Agency market basket index unless otherwise noted on Supplement 1, page 1b to the 4.19-B section.

MEDICAL ASSISTANCE  
STATE NORTH CAROLINA

PAYMENTS FOR MEDICAL AND REMEDIAL CARE AND SERVICES

---

Provided in an Adult Care Home

The Division of Medical Assistance shall enter into agreements with adult care home providers in accordance with 42 CFR 431.107 for the provision of personal care services for State/County Special Assistance clients and those clients described in 42 CFR §435.135 residing in public and private adult care homes.

Reimbursement is determined by the Division of Medical Assistance based on a review of industry costs and determination of reasonable costs with annual inflation adjustments. The initial basic fee was based on service per resident day. The initial basic fee was computed by determining the estimated salary, fringes, direct supervision and allowable overhead. Effective January 1, 2000 the cost of medication administration and personal care services direct supervision were added to the basic rate.

Additional payments are made utilizing the basic fee as a factor for a Medicaid eligible resident that has a demonstrated need for additional care. The enhanced rates include eating, toileting, ambulation/locomotion or special care units (Alzheimer's) which are added to the initial basic rate.

The agency's fee schedule rate was set as of October 1, 2004 and is effective for services provided on or after that date. All rates are published <http://www.ncdhhs.gov/dma/fee/index.htm>.

The rates were calculated from a cost reporting period selected by the state thereby developing the established fee schedule. The fees are reviewed annually and adjusted using the Medicare Home Health index, not to exceed that amount allowed by the North Carolina General Assembly. Notwithstanding any other provision, if specified these rates will be adjusted as shown on Supplement 2, page 1 to the 4.19-B section of the state plan.

Effective January 1, 2000, payments to providers were cost settled with any overpayment repaid to the Division of Medical Assistance. The first cost settlement period was for the nine months ended September 30, 2000. Subsequently, the annual cost settlement period shall be the twelve months ending September 30. No additional payment will be made due to cost settlement. Through review of annual provider cost reports, any provider receiving payments in excess of cost would have monies recouped and returned to the North Carolina Department of Health & Human Services (NCDHHS) Controller's Office with the federal share returned via the CMS 64 cost report. Methodology listed above will be end dated effective May 9, 2010, all payments for cost reporting periods ending on and after December 31, 2009 shall be prospective and not subject to cost settlement.

Effective May 10, 2010, except as otherwise noted in the plan, state-developed fee schedule rates are the same for both governmental and private providers of personal care services in Adult Care Homes. The agency's fee schedule rate was set as of October 1, 2009. All rates are published at <http://www.ncdhhs.gov/dma/fee/index.htm>.

MEDICAL ASSISTANCE  
STATE NORTH CAROLINA

PAYMENTS FOR MEDICAL AND REMEDIAL CARE AND SERVICES

---

B. Provided in Adult Care Homes (continued)

The initial basic fee was based on 1.1 hours of service per resident day. The initial basic fee was computed by determining the estimated salary, fringes, direct supervision, cost of medication administration, and allowable overhead. Reimbursement does not include room and board in the rate. Additional payments are made utilizing the basic fee as a factor for a Medicaid eligible resident that has a demonstrated need for additional care. The enhanced rates include eating, toileting, ambulation/locomotion or special care units (Alzheimer's) billed in addition to the initial basic using the appropriate published HCPCS code for the enhanced service rendered. This methodology will end April 30, 2012.

Beginning May 1, 2012, Personal Care Services provided in Adult Care Homes will be reimbursed the same as Personal Care Services as described on page 4.19-B Section 23, Page 6.

Except as otherwise noted in the plan, state-developed fee schedule rates are the same for both governmental and private providers of Personal Care Services for Adults and Children. The agency's fee schedule rate was set as of November 1, 2011 and is effective for services provided on or after that date. All rates are published at <http://www.ncdhhs.gov/dma/fee/index.htm>.

This methodology ends December 31, 2012.

STATE PLAN UNDER TITLE XIX OF THE SOCIAL SECURITY ACT  
MEDICAL ASSISTANCE PROGRAM

STATE NORTH CAROLINA

METHODS AND STANDARDS FOR ESTABLISHING PAYMENT RATES - OTHER TYPES OF CARE

Item.. VII Payment of Title XVIII Part A and Part B  
Deductible/Coinsurance

Except for a nominal recipient co-payment, if applicable, the Medicaid agency uses the following method:

	Medicare-Medicaid Individual	Medicare-Medicaid/QMB Individual	Medicare QMB Individual
Part A Deductible	<input checked="" type="checkbox"/> Limited to State Plan rates* Full amount	<input checked="" type="checkbox"/> Limited to State Plan rates* Full amount	<input checked="" type="checkbox"/> Limited to State Plan rates* Full amount
Part A Coinsurance	<input checked="" type="checkbox"/> Limited to State Plan rates* Full amount	<input checked="" type="checkbox"/> Limited to State Plan rates* Full amount	<input checked="" type="checkbox"/> Limited to State Plan rates* Full amount
Part B Deductible	<input checked="" type="checkbox"/> Limited to State Plan rates* Full amount	<input checked="" type="checkbox"/> Limited to State Plan rates* Full amount	<input checked="" type="checkbox"/> Limited to State Plan rates* Full amount
Part B Coinsurance	<input checked="" type="checkbox"/> Limited to State Plan rates* Full amount	<input checked="" type="checkbox"/> Limited to State Plan rates* Full amount	<input checked="" type="checkbox"/> Limited to State Plan rates* Full amount

\*For these title XVIII services not otherwise covered by the title XIX State plan, the Medicaid agency has established reimbursement methodologies that are described in 4.19-B, Item(s) \_\_\_\_\_

STATE PLAN UNDER TITLE XIX OF THE SOCIAL SECURITY ACT MEDICAL ASSISTANCE PROGRAM

STATE: NORTH CAROLINA

METHODS AND STANDARDS FOR ESTABLISHING PAYMENT RATES - OTHER TYPES OF CARE

---

Item.. VIII Payment of Title XVIII Part B Outpatient Psychiatric Reduction

Except for a nominal recipient co-payment, if applicable, the Medicaid agency uses the following method:

	Medicare-Medicaid Individual	Medicare-Medicaid/QMB Individual	Medicare QMB Individual
Part B Outpatient Psychiatric Reduction	<u>X</u> Limited to State Plan rates*  Full amount	<u>X</u> Limited to State Plan rates*  Full amount	<u>X</u> Limited to State Plan rates*  Full amount

\*For these title XVIII services not otherwise covered by the title XIX State plan, the Medicaid agency has established reimbursement methodologies that are described in 4.19-B, Item(s)\_\_\_\_  
\_\_\_\_\_

---

TN No. 08-003  
Supersedes  
TN No. New

Approval Date: 08/15/08

Effective Date 04/01/2008



State: North Carolina

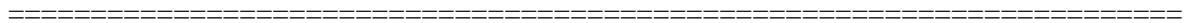

REIMBURSEMENT FOR INDIAN HEALTH SERVICE  
AND TRIBAL 638 HEALTH FACILITIES

- a) Payment for services to Indian Health Service and Tribal 638 Health Facilities is based upon the amounts as determined and published in the Federal Register by the United States Government for these providers.
- b) In addition to the payments received in paragraph (a) of this section, Indian Health Services and Tribal 638 Health Facilities are eligible to receive two enhanced payments when they are enrolled in the Medicaid program as Pregnancy Medical Home provider (PMH). A PMH is defined in Attachment 3.1-B, Page 7(a) and Attachment 3.1-F of this state plan.

Two enhanced payments may be made to the PMH providers. Upon completion of the high risk screening, an enhanced payment of \$50.00 will be made to the PMH. Upon completion of the recipient's post partum visit, an enhanced payment of \$150.00 will be made to the PMH provider. The PMH providers will receive a maximum of \$200 enhanced payments per recipient per pregnancy even if there are multiple births.

Except as otherwise noted in the plan, state-developed fee schedule rates are the same for both governmental and private PMH providers. The above enhanced payments are PMH fee schedule rates were set as of March 1, 2011 and are effective for services provided on or after that date. The fee schedule is published on the agency's website at <http://www.ncdhhs.gov/dma/fee/fee.htm>.

There shall be no cost settlement for any provider in any setting for these services reimbursed at the enhanced rates.

Notwithstanding any other provision, if specified, these rates will be adjusted as shown on Attachment 4.19-B, Supplement 3, Page 1 of the State Plan.

State Plan Under Title XIX of the Social Security Act  
Medical Assistance Program  
State: North Carolina

Payments for Medical and Remedial Care and Services

---

Payment for Home Health Services:

FY 2003 – No adjustment for other services.

FY 2005 and 2006 – No rate increase from the June 30, 2005 rate for all Medicaid private and public providers with the following exceptions: federally qualified health clinics, rural health centers, state institutions, outpatient hospital, pharmacy and the non-inflationary components of the case-mix reimbursement system for nursing facilities

NC General Assembly legislation mandates that effective July 1, 2005, reimbursement rates for these programs (Home Health) for the state fiscal years 2005- 2006 and 2006-2007 will remain at the rate in effect as of June 30, 2005.

FY 2007 - Effective 1/1/2007 inflationary increases were applied to the following programs:

Home Health received an increase of 2.98%.

FY 2009-2010 – No inflationary adjustment and 5.73% rate reduction (annualized over nine months) for Home Health.

FY 2010-2011- No inflationary or rate adjustments for Home Health.

FY 2012 – Rates will be frozen at the rate in effect on June 30, 2011. Effective November 1, 2011, existing rates are adjusted by a negative 2.67% to yield a twelve (12) month two percent (2%) reduction in the nine (9) remaining months of this State Fiscal Year.

FY 2013 – Effective July 1, 2012, the rates will be adjusted such that they will equal 98% of the rate in effect July 1, 2011. There will be no further annual adjustments this State Fiscal Year.

SFY 2014 – The rates will be frozen at the rates in effect on June 30, 2013. There will be no further annual adjustment.

SFY 2015 - Rates will be frozen at the rate in effect on June 30, 2014. There will be no further annual adjustments this state fiscal year.

Reference: Attachment 4.19-B, Section 7, Pages 1- 4

---

TN No: 13-039  
Supersedes  
TN No: 11-037

Approval Date : 12-12-13

Eff. Date: 8/1/2013

State Plan Under Title XIX of the Social Security Act  
Medical Assistance Program  
State: North Carolina

Payments for Medical and Remedial Care and Services

---

Payment for Rehabilitation Services:

FY 2005 and 2006 – No rate increase from the June 30, 2005 rate for all Medicaid private and public providers with the following exceptions: federally qualified health clinics, rural health centers, state institutions, outpatient hospital, pharmacy and the non-inflationary components of the case-mix reimbursement system for nursing facilities.

NC General Assembly legislation mandates that effective July 1, 2005, reimbursement rates for Rehabilitation Services for the state fiscal years 2005-2006 and 2006-2007 will remain at the rate in effect as of June 30, 2005, except Medicaid rates may be adjusted downward in accordance with the current year's downward adjustments to the Medicare fee schedule.

SFY 2010 – The rates for SFY2010 are frozen as of the rates in effect at July 1, 2009 except Medicaid rates may be adjusted downward in accordance with the current year's downward adjustments to the Medicare fee schedule. Effective October 1, 2009, an overall program reduction of 4.68% was applied. There will be no further annual adjustment.

SFY 2011 – The rates for SFY2011 are frozen as of the rates in effect at July 1, 2010. There will be no further annual adjustment.

Reference: Attachment 4.19-B, Section 13

---

TN No. 09-017  
Supersedes  
TN No. 07-003

Approval Date: 02-04-10

Eff. Date 07/01/2009

State Plan Under Title XIX of the Social Security Act  
Medical Assistance Program  
State: North Carolina

Payments for Medical and Remedial Care and Services

---

Payment for Personal Care Services for Adults and Children:

SFY 2012 – Rates will be frozen at the rate in effect on June 30, 2011. Effective November 1, 2011, existing rates are adjusted by a negative 2.67% to yield a twelve (12) month two percent (2%) reduction in the nine (9) remaining months of this State Fiscal Year.

SFY 2013 – Effective July 1, 2012, the rates will be adjusted such that they will equal 98% of the rate in effect July 1, 2011. There will be no further annual adjustments this state fiscal year. This methodology ends December 31, 2012.

SFY 2013 – Effective January 1, 2013, a new rate is established as calculated in the methodology as described on Attachment 4.19-B, Section 23, Page 6.

All rates for this service are published at <http://www.ncdhhs.gov/dma/fee/index.htm>.

SFY 2014 – Effective October 1, 2013, a new rate is established as calculated in the methodology as described on Attachment 4.19-B, Section 23, Page 6.

Effective January 1, 2014 rates will be adjusted such that they will equal 97% of the rate in effect December 31, 2013.

Reference: Attachment 4.19-B, Section 23, Page 6

---

TN. No. 14-009  
Supersedes  
TN. No. 13-009

Approval Date: 06-27-14

Eff. Date: 01/01/2014

State Plan Under Title XIX of the Social Security Act  
Medical Assistance Program  
State: North Carolina

Payments for Medical and Remedial Care and Services

---

Payment for Private Duty Nursing Services:

FY 2003 – A 5% rate reduction is applied to Private Duty Nursing.

FY 2005 and 2006 – No rate increase from the June 30, 2005 rate for all Medicaid private and public providers with the following exceptions: federally qualified health clinics, rural health centers, state institutions, outpatient hospital, pharmacy and the non-inflationary components of the case-mix reimbursement system for nursing facilities

NC General Assembly legislation mandates that effective July 1, 2005, reimbursement rates for Private Duty Nursing for the state fiscal years 2005- 2006 and 2006-2007 will remain at the rate in effect as of June 30, 2005.

FY 2007 - Effective 1/1/2007 an inflationary increase of 4.25% is applied to Private Duty Nursing services.

FY 2009-2010 – No inflationary adjustment and 5.73% rate reduction (annualized over nine months) for Private Duty Nursing.

FY 2010-2011- No inflationary or rate adjustments are made for Private Duty Nursing.

FY 2012 – Rates will be frozen at the rate in effect on June 30, 2011. Effective November 1, 2011, existing rates are adjusted by a negative 2.67% to yield a twelve (12) month two percent (2%) reduction in the nine (9) remaining months of this State Fiscal Year.

FY 2013 – Effective July 1, 2012, the rates will be adjusted such that they will equal 98% of the rate in effect July 1, 2011. There will be no further annual adjustments this State Fiscal Year.

SFY 2014 – The rates will be frozen at the rates in effect on June 30, 2013. There will be no further annual adjustment.

SFY 2015 - Rates will be frozen at the rate in effect on June 30, 2014. There will be no further annual adjustments this state fiscal year.

Reference: Attachment 4.19-B, Section 8, Page 1

---

TN No: 13-039  
Supersedes  
TN No: 11-037

Approval Date: 12/12/13

Eff. Date: 8/1/2013

State Plan Under Title XIX of the Social Security Act  
Medical Assistance Program  
State: North Carolina

Payments for Medical and Remedial Care and Services

---

---

Payment for Local Education Agencies:

SFY 2010 – The rates for SFY 2010 are frozen at the rates in effect on July 1, 2009 except Medicaid rates may be adjusted downward in accordance with the current year's downward adjustment to the Medicare fee schedule. Effective October 1, 2009, a negative inflationary adjustment of 9.0% was applied to the existing rates. There will be no further annual adjustment.

SFY 2011 – The rates for SFY 2011 will be frozen at the rates in effect on June 30, 2010.

SFY 2012 - The rate for SFY2012 is frozen as of the rate in effect at July 1, 2011. Thereafter, the rate shall be reviewed annually, not later than March 1<sup>st</sup> of each succeeding calendar year.

SFY 2014 – Effective August 1, 2013, the rates are frozen as of the rate in effect at June 30, 2013. There will be no further annual adjustments this state fiscal year except that Medicaid rates may be adjusted downward in accordance with the current years downward adjustments to the Medicare fee schedule.

SFY 2015 – Effective July 1, 2014, the rates are frozen at the rate in effect as of June 30, 2014. There will be no further annual adjustments this state fiscal year except that Medicaid rates may be adjusted downward in accordance with the current years downward adjustments to the Medicare fee schedule.

Reference: Attachment 4.19-B, Section 6, Page 3

---

TN. No: 13-028  
Supersedes  
TN. No: 11 041

Approval Date: 12-12-13

Eff. Date 08/01/2013

State Plan Under Title XIX of the Social Security Act  
Medical Assistance Program  
State: North Carolina

Payments for Medical and Remedial Care and Services

---

Payment for Nurse-Midwife, Certified Registered Nurse Anesthetist (CRNA) & Anesthesiologist Assistants:

SFY 2004 – No adjustment for Nurse-Midwives, CRNA and AA fees.

SFY 2005 and 2006 – No rate increase from the June 30, 2005 rate for all Medicaid private and public providers with the following exceptions: federally qualified health clinics, rural health centers, state institutions, outpatient hospital, pharmacy and the non-inflationary components of the case-mix reimbursement system for nursing facilities.

NC General Assembly legislation mandates that effective July 1, 2005, reimbursement rates for Nurse-Midwife for the state fiscal years 2005-2006 and 2006-2007 will remain at the rate in effect as of June 30, 2005 except Medicaid rates may be adjusted downward in accordance with the current year's downward adjustments to the Medicare fee schedule.

SFY 2007 - Effective January 1, 2007 an inflationary increase of 5.171% was applied.

SFY 2010 –The rates for SFY 2010 are frozen as of the rates in effect at July 1, 2009, except Medicaid rates may be adjusted downward in accordance with the current years downward adjustments to the Medicare fee schedule. Effective October 1, 2009, an overall negative rate adjustment of 4.90% was applied. There will be no further annual rate adjustment for SFY 2010.

SFY 2011 – The rates for SFY 2011 will be frozen at the rates in effect on June 30, 2010.

SFY 2012 – Rates will be frozen at the rate in effect on June 30, 2011. Effective November 1, 2011, existing rates are adjusted by a negative 2.67% to yield a twelve (12) month two percent (2%) reduction in the nine (9) remaining months of this State Fiscal Year.

SFY 2013 – Effective July 1, 2012, the rates will be adjusted such that they will equal 98% of the rate in effect July 1, 2011. There will be no further annual adjustments this state fiscal year except that Medicaid rates may be adjusted downward in accordance with the current years downward adjustments to the Medicare fee schedule.

SFY 2014 – Effective August 1, 2013, the rates are frozen as of the rate in effect at June 30, 2013. Effective January 1, 2014, the rates for CRNA and Nurse-Midwives will be reimbursed at 98% of the current Medicaid physician fee schedule. Effective January 1, 2014, the rates for Anesthesiologist Assistants will be reimbursed at 50% of the current Anesthesiologist rates for DMA approved procedures (CPT and HCPCS). There will be no further annual adjustments this state fiscal year except that Medicaid rates may be adjusted downward in accordance with the current year's downward adjustments to the Medicare fee schedule.

SFY 2015 – Effective July 1, 2014, the rates for CRNA and Nurse-Midwives will be reimbursed at 98% of the current Medicaid physician fee schedule. Effective July 1, 2014, the rates for Anesthesiologist Assistants will be reimbursed at 50% of the current Anesthesiologist rates for DMA approved procedures (CPT and HCPCS). There will be no further annual adjustments this state fiscal year except that Medicaid rates may be adjusted downward in accordance with the current year's downward adjustments to the Medicare fee schedule.

Reference: Attachment 4.19-B, Section 17, pages 1 and 2

---

TN-No: 14-012  
Supersedes  
TN- No. 13-027

Approval Date: 06-27-14

Eff. Date: 01/01/2014

State Plan Under Title XIX of the Social Security Act  
Medical Assistance Program  
State: North Carolina

Payments for Medical and Remedial Care and Services

---

Payment for Home Infusion Therapy:

SFY 2005 and 2006 – No rate increase from the June 30, 2005 rate for all Medicaid private and public providers with the following exceptions: federally qualified health clinics, rural health centers, state institutions, outpatient hospital, pharmacy and the non-inflationary components of the case-mix reimbursement system for nursing facilities.

NC General Assembly legislation mandates that effective July 1, 2005, reimbursement rates for these programs (Home Infusion Therapy) for the state fiscal years 2005-2006 and 2006-2007 will remain at the rate in effect as of June 30, 2005, except Medicaid rates may be adjusted downward in accordance with the current year's downward adjustments to the Medicare fee schedule.

SFY 2007 - Effective 1/1/2007 inflationary increase of 2.39% was applied to Home Infusion Therapy.

SFY 2010 – The rates for SFY 2010 are frozen as of the rates in effect at July 1, 2009. Effective October 1, 2009, an overall rate reduction adjustment of 4.12 % was applied to Home Infusion Therapy rates. There will be no further annual adjustment.

SFY 2011 - As of July 1, 2010, rates will be frozen.

SFY 2012 – Rates will be frozen at the rate in effect on June 30, 2011. Effective November 1, 2011, existing rates are adjusted by a negative 2.67% to yield a twelve (12) month two percent (2%) reduction in the nine (9) remaining months of this State Fiscal Year.

SFY 2013 – Effective July 1, 2012, the rates will be adjusted such that they will equal 98% of the rate in effect July 1, 2011. There will be no further annual adjustments this state fiscal year except that Medicaid rates may be adjusted downward in accordance with the current years downward adjustments to the Medicare fee schedule.

SFY 2014 – As of July 1, 2013 rates will be frozen as in effect June 30, 2013. There will be no further adjustments except that Medicaid rates may be adjusted downward in accordance with the applicable years downward adjustments to the Medicare fee schedule.

SFY 2015 - As of July 1, 2014 rates will be frozen as in effect June 30, 2014. There will be no further adjustments except that Medicaid rates may be adjusted downward in accordance with the applicable years downward adjustments to the Medicare fee schedule.

Reference: Attachment 4.19-B, Section 7, Page 5

---

TN No. 13-025  
Supersedes  
TN No. 11-023

Approval Date: 12-11-13

Eff. Date: 08-01-2013



State Plan Under Title XIX of the Social Security Act  
Medical Assistance Program  
State: North Carolina

Payments for Medical and Remedial Care and Services

---

Extended services to pregnant women

SFY 2010 –The rates for SFY 2010 are frozen as of the rates in effect at July 1, 2009, except Medicaid rates may be adjusted downward in accordance with the current years downward adjustments to the Medicare fee schedule. Effective October 1, 2009, an overall negative rate adjustment of 9.76 % was applied. There will be no further annual rate adjustment for SFY 2010.

SFY 2011 - For SFY 2011, the rate will be frozen at the rate in effect on June 30, 2010.

SFY 2012 – Frozen rates will be adjusted effective November 1, 2011, existing rates are adjusted by a negative 2.67% to yield a twelve (12) month two percent (2%) reduction in the nine (9) remaining months of this State Fiscal Year for all Medicaid private and public providers with the following exception: Local Health Departments.

SFY 2013 – Effective July 1, 2012, the rates will be adjusted such that they will equal 98% of the rate in effect July 1, 2011 for all Medicaid private and public providers with the following exception: Local Health Departments. There will be no further annual adjustments this state fiscal year.

SFY 2014 – Effective August 1, 2013, the rates will be frozen at the rate in effect on June 30, 2013. There will be no further annual adjustments.

SFY 2015 - Effective July 1, 2014, the rates will be frozen at the rate in effect on June 30, 2014. There will be no further annual adjustments.

Reference: Attachment 4.19-B, Section 20, Page 1

---

TN No. 13-019  
Supersedes  
TN No. 11-032

Approval Date: 12-11-13

Effective Date: 08-01-2013

MEDICAL ASSISTANCE  
State: NORTH CAROLINA

PAYMENTS FOR MEDICAL AND REMEDIAL CARE AND SERVICE

---

Freestanding Birth Center Services

SFY 2012 – There will be no Medicare Market Basket Index rate increase in SFY 2012.

SFY 2013 – Effective July 1, 2012, the rates will be frozen at the rate in effect October 6, 2011. There will be no further annual adjustments this state fiscal year.

Reference: Attachment 4.19-B, Section 9, Page 3

---

TN. No. 11-052  
Supersedes  
TN. No. NEW

Approval Date 1-20-12

Eff. Date: 10-06-2011

State Plan Under Title XIX of the Social Security Act  
Medical Assistance Program  
State: North Carolina

Payments for Medical and Remedial Care and Services

---

Payment for Personal Care (Adult Care Home):

FY 2003 – No adjustment.

FY 2004 – No adjustment for Personal Care (Adult Care Homes) effective October 1, 2003.

FY 2005 and 2006 – No rate increase from the June 30, 2005 rate for all Medicaid private and public providers with the following exceptions: federally qualified health clinics, rural health centers, state institutions, outpatient hospital, pharmacy and the noninflationary components of the case-mix reimbursement system for nursing facilities.

NC General Assembly legislation mandates that effective July 1, 2005, reimbursement rates for Personal Care (Adult Care Home) for the state fiscal years 2005-2006 and 2006-2007 will remain at the rate in effect as of June 30, 2005.

FY 2007 – Effective July 1, 2007 an inflationary increase of 2.64% was applied.

FY 2009-2010 – No inflationary adjustment and 5.02% rate reduction (annualized over nine months) for Personal Care (Adult Care Home).

FY 2010 – 2011 – No inflationary or rate adjustment for Personal Care (Adult Care Home).

FY 2011-2012 - Effective July 1, 2011, rates will remain frozen at the rate in effect on June 30, 2011.

This methodology ends December 31, 2012.

Reference: Attachment 4.19-B, Section 23, Page 6b.

---

TN. No: 12-005

Supersedes

TN. No: 12-003

Approval Date: 04-04-12

Eff. Date: 05/01/2012

State Plan Under Title XIX of the Social Security Act  
Medical Assistance Program  
State: North Carolina

Payments for Medical and Remedial Care and Services

---

Payment for Transportation:

SFY 2003 – No adjustment.

SFY 2004 – No Adjustments for Transportation effective October 1, 2003.

SFY 2005 and 2006 – No rate increase from the June 30, 2005 rate for all Medicaid private and public providers with the following exceptions: federally qualified health clinics, rural health centers, state institutions, outpatient hospital, pharmacy and the non-inflationary components of the case-mix reimbursement system for nursing facilities.

NC General Assembly legislation mandates that effective July 1, 2005, reimbursement rates for Transportation for the state fiscal years 2005-2006 and 2006-2007 will remain at the rate in effect as of June 30, 2005.

SFY 2010 – No inflationary adjustment.

SFY 2011 - No inflationary adjustment.

SFY 2012 – Rates will be frozen at the rate in effect on June 30, 2011. Effective November 1, 2011, existing rates are adjusted by a negative 2.66% to yield a twelve (12) month two percent (2%) reduction in the nine (9) remaining months of this State Fiscal Year.

SFY 2013 – Effective July 1, 2012, the rates will be adjusted such that they will equal 98% of the rate in effect July 1, 2011. There will be no further annual adjustments this state fiscal year except that Medicaid rates may be adjusted downward in accordance with the current years downward adjustments to the Medicare fee schedule.

SFY 2014 – Effective August 1, 2013, the rates are frozen as of the rate in effect at June 30, 2013. There will be no further annual adjustments this state fiscal year except that Medicaid rates may be adjusted downward in accordance with the current years downward adjustments to the Medicare fee schedule.

SFY 2015 – Effective July 1, 2014, the rates are frozen at the rate in effect as of June 30, 2014. There will be no further annual adjustments this state fiscal year except that Medicaid rates may be adjusted downward in accordance with the current years downward adjustments to the Medicare fee schedule.

Reference: Attachment 4.19-B, Section 23, Page 1 through 1f

---

TN. No: 13-031  
Supersedes  
TN. No: 11-025

Approval Date: 12-12-13

Eff. Date: 08/01/2013

State Plan Under Title XIX of the Social Security Act  
Medical Assistance Program  
State: North Carolina

Payments for Medical and Remedial Care and Services

---

Payment for Medical Equipment:

SFY 2003 – No adjustment.

SFY 2004 – No adjustment for Durable Medical Equipment effective August 1, 2003.

SFY 2005 and 2006 – No rate increase from the June 30, 2005 rate for all Medicaid private and public providers with the following exceptions: federally qualified health clinics, rural health centers, state institutions, outpatient hospital, pharmacy and the non-inflationary components of the case-mix reimbursement system for nursing facilities.

NC General Assembly legislation mandates that effective July 1, 2005, reimbursement rates for Medical Equipment for the state fiscal years 2005-2006 and 2006-2007 will remain at the rate in effect as of June 30, 2005 except Medicaid rates may be adjusted downward in accordance with the current year's downward adjustments to the Medicare fee schedule.

SFY 2010 – The rates for SFY 2010 are frozen as of the rates in effect at July 1, 2009, except Medicaid rates may be adjusted downward in accordance with the current year's downward adjustments to the Medicare fee schedule. Effective October 1, 2009, an overall rate adjustment of -4.16% was applied to the existing rates. There will be no further annual adjustment.

SFY 2011 – For SFY 2011, the rate will be frozen at the rate in effect on June 30, 2010.

SFY 2012 – Rates will be frozen at the rate in effect on June 30, 2011. Effective November 1, 2011, existing rates are adjusted by a negative 2.66% to yield a twelve (12) month two percent (2%) reduction in the nine (9) remaining months of this State Fiscal Year.

SFY 2013 – Effective July 1, 2012, the rates will be adjusted such that they will equal 98% of the rate in effect July 1, 2011. There will be no further annual adjustments this state fiscal year except that Medicaid rates may be adjusted downward in accordance with the current years downward adjustments to the Medicare fee schedule.

SFY 2014 – As of July 1, 2013 rates will be frozen as in effect June 30, 2013. There will be no further adjustments except that Medicaid rates may be adjusted downward in accordance with the applicable years downward adjustments to the Medicare fee schedule.

Reference: Attachment 4.19-B, Section 7, Page 4

---

TN. No: 13-013  
Supersedes  
TN. No: 11-019

Approval Date: 12-11-13

Eff. Date 08/01/13

State Plan Under Title XIX of the Social Security Act  
Medical Assistance Program  
State: North Carolina

Payments for Medical and Remedial Care and Services

---

Payment for Medical Equipment Continued:

SFY 2015 - As of July 1, 2014 rates will be frozen as in effect June 30, 2014. There will be no further adjustments except that Medicaid rates may be adjusted downward in accordance with the applicable years downward adjustments to the Medicare fee schedule.

Reference: Attachment 4.19-B, Section 7, Page 4

---

TN. No: 13-013  
Supersedes  
TN. No: NEW

Approval Date: 12-11-13

Eff. Date 8/01/13

State Plan Under Title XIX of the Social Security Act  
Medical Assistance Program  
State: North Carolina

Payments for Medical and Remedial Care and Services

---

Payment for Dialysis Centers:

SFY 2003 – No adjustment.

SFY 2005 and 2006 – No rate increase from the June 30, 2005 rate for all Medicaid private and public providers with the following exceptions: federally qualified health clinics, rural health centers, state institutions, outpatient hospital, pharmacy and the non-inflationary components of the case-mix reimbursement system for nursing facilities.

SFY 2007 – Effective July 1, 2006 an inflationary increase of 6.883% was applied.

SFY 2010 – No inflationary adjustment allowed.

SFY 2011- No inflationary adjustment allowed.

SFY 2012 – Rates will be frozen at the rate in effect on June 30, 2011. Effective November 1, 2011, existing rates are adjusted by a negative 2.67% to yield a twelve (12) month two percent (2%) reduction in the nine (9) remaining months of this State Fiscal Year.

SFY 2013 – Effective July 1, 2012, the rates will be adjusted such that they will equal 98% of the rate in effect July 1, 2011. There will be no further annual adjustments this state fiscal year.

SFY 2014 – Effective August 1, 2013, the rates will be frozen at the rate in effect on June 30, 2013. There will be no further annual adjustments except that Medicaid rates may be adjusted downward in accordance with the applicable years downward adjustments to the Medicare fee schedule.

SFY 2015 – Effective July 1, 2014, the rates will be frozen at the rate in effect on June 30, 2014. There will be no further annual adjustments except that Medicaid rates may be adjusted downward in accordance with the applicable years downward adjustments to the Medicare fee schedule.

Reference: Attachment 4.19-B, Section 9, Page 1a.

---

TN. No: 13-020  
Supersedes  
TN. No: 11-016

Approval Date: 12-11-13

Eff. Date 8-01-2013

State Plan Under Title XIX of the Social Security Act  
Medical Assistance Program  
State: North Carolina

Payments for Medical and Remedial Care and Services

---

Payment for Ambulatory Surgical Centers:

SFY 2003 – No adjustment.

SFY 2004 – No Adjustments for Ambulatory Surgical Centers effective October 1, 2003.

SFY 2005 and 2006 – No rate increase from the June 30, 2005 rate for all Medicaid private and public providers with the following exceptions: federally qualified health clinics, rural health centers, state institutions, outpatient hospital, pharmacy and the non-inflationary components of the case-mix reimbursement system for nursing facilities.

NC General Assembly legislation mandates that effective July 1, 2005, reimbursement rates for Ambulatory Surgical Centers for the state fiscal years 2005-2006 and 2006-2007 will remain at the rate in effect as of June 30, 2005.

SFY 2007 – Effective July 1, 2006 an inflationary increase of 9.169% was applied.

SFY 2010 – The rates for SFY 2010 are frozen as of the rates in effect at July 1, 2009, except Medicaid rates may be adjusted downward in accordance with the current year's downward adjustments to the Medicare fee schedule. Effective October 1, 2009, an overall negative rate adjustment of 4.095% was applied. There will be no further annual adjustment.

SFY 2011 – The rates for SFY 2011 will be frozen at the rates in effect on June 30, 2010.

SFY 2012 – Rates will be frozen at the rate in effect on June 30, 2011. Effective November 1, 2011, existing rates are adjusted by a negative 2.67% to yield a twelve (12) month two percent (2%) reduction in the nine (9) remaining months of this State Fiscal Year.

SFY 2013 – Effective July 1, 2012, the rates will be adjusted such that they will equal 98% of the rate in effect July 1, 2011. There will be no further annual adjustments this state fiscal year except that Medicaid rates may be adjusted downward in accordance with the current years downward adjustments to the Medicare fee schedule.

SFY 2014 – Effective August 1, 2013, the rates are frozen as of the rate in effect at June 30, 2013. There will be no further annual adjustments this state fiscal year except that Medicaid rates may be adjusted downward in accordance with the current years downward adjustments to the Medicare fee schedule.

SFY 2015 – Effective July 1, 2014, the rates are frozen at the rate in effect as of June 30, 2014. There will be no further annual adjustments this state fiscal year except that Medicaid rates may be adjusted downward in accordance with the current years downward adjustments to the Medicare fee schedule.

Reference: Attachment 4.19-B, Section 9, Page 2.

---

TN. No: 13-037  
Supersedes  
TN. No: 11-024

Approval Date: 12-12-13

Eff. Date 08/01/13



State Plan Under Title XIX of the Social Security Act  
Medical Assistance Program  
State: North Carolina

Payments for Medical and Remedial Care and Services

---

Payment for Hospice:

Reference: Attachment 4.19-B, Section 18, Page 1

---

TN. No: 09-011  
Supersedes  
TN. No: NEW

Approval Date: 05-12-10

Eff. Date: 07/01/2009

State Plan Under Title XIX of the Social Security Act  
Medical Assistance Program  
State: North Carolina

Payments for Medical and Remedial Care and Services

---

Payment for Non-Emergency Transportation:

Reference: Attachment 4.19-B, Section 23, Page 1g

---

TN. No: 12-011  
Supersedes  
TN. No: NEW

Approval Date: 12-07-12

Eff. Date: October 1, 2012

State Plan under Title XIX of the Social Security Act  
Medical Assistance Program  
State: North Carolina

Payments for Medical and Remedial Care and Services

---

LEAVE BLANK

---

TN No: 10-035B  
Supersedes  
TN No: NEW

Approval Date: 04-25-14

Eff. Date: 03/01/2011

State Plan under Title XIX of the Social Security Act  
Medical Assistance Program  
State: North Carolina

Payments for Medical and Remedial Care and Services

---

Payment for Physician Services:

SFY 2004 – No adjustment. Physician Fees

SFY 2005 and 2006 – No rate increase from the June 30, 2005 rate for all Medicaid private and public providers with the following exceptions: federally qualified health clinics, rural health centers, state institutions, outpatient hospital, pharmacy and the non-inflationary components of the case-mix reimbursement system for nursing facilities.

North Carolina General Assembly legislation mandates that effective July 1, 2005, reimbursement rates for Physician Fees for the state fiscal years 2005-2006 and 2006-2007 will remain at the rate in effect as of June 30, 2005 except Medicaid rates may be adjusted downward in accordance with the current year's downward adjustments to the Medicare fee schedule.

SFY 2007 - Effective January 1, 2007 an inflationary increase of 5.171% was applied.

SFY 2010 –The rates for SFY 2010 are frozen as of the rates in effect at July 1, 2009, except Medicaid rates may be adjusted downward in accordance with the current years downward adjustments to the Medicare fee schedule. Effective October 1, 2009, an overall negative rate adjustment of 4.90% was applied. There will be no further annual rate adjustment for SFY 2010.

SFY 2011 – The rates for SFY 2011 will be frozen at the rates in effect on June 30, 2010.

SFY 2012 - The rates for SFY2012 are frozen as of the rates in effect at July 1, 2011. Thereafter, the rates shall be reviewed annually, not later than March 1<sup>st</sup> of each succeeding calendar year.

SFY 2014 – Rates will be frozen at the rate in effect June 30, 2013. Effective January 1, 2014 rates will be adjusted such that they will equal 97% of the rate in effect July 1, 2013. Those physicians who have attested as being a primary care physician under Section 1202 of the Affordable Care Act shall be excluded from this reduction until January 1, 2015, at which time their reimbursement will be at 97% if the July 1, 2013 rates. There will be no further annual adjustments this state fiscal year except that Medicaid rates may be adjusted downward in accordance with the current years downward adjustments to the Medicare fee schedule.

Reference: Attachment 4.19-B, Section 5

---

TN-No: 14-012  
Supersedes  
TN- No. 13-033

Approval Date 06-27-14

Eff. Date: 01/01/2014

State Plan Under Title XIX of the Social Security Act  
Medical Assistance Program  
State: North Carolina

---

Payments for Medical and Remedial Care and Services

---

Payment for Dental:

FY 2007 - Effective January 1, 2007 inflationary increases were applied to the following program:

Dental providers received an increase of 23.61%,

SFY 2009 – The rates for Dental Services are frozen at the rates in effect on December 31, 2008.

SFY 2010 – The rates for SFY 2010 are frozen as of the rates in effect at July 1, 2009. Effective October 1, 2009, a negative inflationary adjustment of 5.79% as applied to the existing rates. There will be no further annual adjustment.

SFY 2011 – As of July 1, 2010 rates will be frozen.

SFY 2012 – Rates will be frozen at the rate in effect on June 30, 2011. Effective November 1, 2011, existing rates are adjusted by a negative 2.67% to yield a twelve (12) month two percent (2%) reduction in the nine (9) remaining months of this State Fiscal Year. Exception: Reimbursement rates paid for composite fillings for back teeth were reduced by 15% (except for D2391 which was reduced by 5%) and a 10% increase as applied to rates paid for amalgam fillings for back teeth.

SFY 2013 – Effective July 1, 2012, the rates will be adjusted such that they will equal 98% of the rate in effect July 1, 2011. There will be no further annual adjustments this state fiscal year. Exception: The rates are frozen at the November 1, 2011 rates for composite fillings for back teeth and for amalgam fillings for back teeth.

SFY 2014 – Effective August 1, 2013, the rates are frozen as of the rates in effect at June 30, 2013. Effective January 1, 2014 rates will be adjusted such that they will equal 97% of the rate in effect July 1, 2013. There will be no further annual rate adjustment.

SFY 2015 – Effective July 1, 2014, the rates are frozen at the rate in effect as of June 30, 2014. There will be no further annual rate adjustment.

Reference: Attachment 4.19-B, Section 10

---

TN- No. 14-004  
Supersedes  
TN-No. 13-012

Approval Date: 08-22-14

Eff. Date: 01/01/2014

State Plan Under Title XIX of the Social Security Act  
Medical Assistance Program  
State: North Carolina

Payments for Medical and Remedial Care and Services

---

Payment for Independent Laboratory and X-Ray:

SFY 2005 and 2006 – No rate increase from the June 30, 2005 rate for all Medicaid private and public providers with the following exceptions: federally qualified health clinics, rural health centers, state institutions, outpatient hospital, pharmacy and the non-inflationary components of the case-mix reimbursement system for nursing facilities.

SFY 2007 - Effective January 1, 2007 inflationary of .595% was applied.

SFY 2010 –The rates for SFY 2010 are frozen as of the rates in effect at July 1, 2009, except Medicaid rates may be adjusted downward in accordance with the current years downward adjustments to the Medicare fee schedule. Effective October 1, 2009, an overall negative rate adjustment of 4.90% was applied. There will be no further annual rate adjustment for SFY 2010.

SFY 2011 – The rates for SFY 2011 will be frozen at the rates in effect on June 30, 2010.

SFY 2012 – Rates will be frozen at the rate in effect on June 30, 2011. Effective November 1, 2011, existing rates are adjusted by a negative 2.66% for Independent Laboratories and 2.67% for X-Ray Services to yield a twelve (12) month two percent (2%) reduction in the nine (9) remaining months of this State Fiscal Year for all Medicaid providers with the following exception: North Carolina State Laboratory rates will remain frozen at the rate in effect on June 30, 2011. Rates for new codes will not include inflation beyond 2009.

SFY 2013 – Effective July 1, 2012, the rates will be adjusted such that they will equal 98% of the rate in effect July 1, 2011 for all Medicaid providers with the following exception: North Carolina State Laboratory rates will remain frozen at the rate in effect on June 30, 2011. There will be no further annual adjustments this state fiscal year. Rates for new codes will not include inflation beyond 2009.

SFY 2014 – Effective August 1, 2013, the rates are frozen as of the rate in effect at June 30, 2013. There will be no further annual adjustments this state fiscal year except that Medicaid rates may be adjusted downward in accordance with the current years downward adjustments to the Medicare fee schedule.

SFY 2015 – Effective July 1, 2014, the rates are frozen at the rate in effect as of June 30, 2014. There will be no further annual adjustments this state fiscal year except that Medicaid rates may be adjusted downward in accordance with the current years downward adjustments to the Medicare fee schedule.

Reference: Attachment 4.19-B, Section 3, page 1

---

TN No: 13-029

Approval Date: 10-20-14

Eff. Date: 08/01/13

Supersedes

TN No. 11-026

State Plan Under Title XIX of the Social Security Act  
Medical Assistance Program  
State: North Carolina

Payments for Medical and Remedial Care and Services

---

Payment for Eyeglasses:

SFY 2005 and 2006 – No rate increase from the June 30, 2005 rate for all Medicaid private and public providers with the following exceptions: federally qualified health clinics, rural health centers, state institutions, outpatient hospital, pharmacy and the non-inflationary components of the case-mix reimbursement system for nursing facilities.

NC General Assembly legislation mandates that effective July 1, 2005, reimbursement rates for eyeglasses for the state fiscal years 2005-2006 and 2006-2007 will remain at the rate in effect as of June 30, 2005 except Medicaid rates may be adjusted downward in accordance with the current year's downward adjustments to the Medicare fee schedule.

SFY 2007 - Effective January 1, 2007 an inflationary increase of 9.00% was applied.

SFY 2010 –The rates for SFY 2010 are frozen as of the rates in effect at July 1, 2009, except Medicaid rates may be adjusted downward in accordance with the current years downward adjustments to the Medicare fee schedule. Effective October 1, 2009, an overall negative rate adjustment of 4.90% was applied. There will be no further annual rate adjustment for SFY 2010.

SFY 2011 – The rates for SFY 2011 will be frozen at the rates in effect on June 30, 2010.

SFY 2012 - Rates will be frozen at the rate in effect on June 30, 2011. Effective November 1, 2011, existing rates are adjusted by a negative 2.66% to yield a twelve (12) month two percent (2%) reduction in the nine (9) remaining months of this State Fiscal Year.

SFY 2013 – Effective July 1, 2012, the rates will be adjusted such that they will equal 98% of the rate in effect July 1, 2011. There will be no further annual adjustments this state fiscal year except that Medicaid rates may be adjusted downward in accordance with the current years downward adjustments to the Medicare fee schedule.

SFY 2014 – Effective August 1, 2013, the rates will be frozen at the rate in effect on June 30, 2013. Effective January 1, 2014 rates will be adjusted such that they will equal 97% of the rate in effect July 1, 2013. There will be no further annual adjustments this state fiscal year except that Medicaid rates may be adjusted downward in accordance with the current years downward adjustments to the Medicare fee schedule.

SFY 2015 – Effective July 1, 2014, the rates will be frozen at the rate in effect on June 30, 2014. There will be no further annual adjustments this state fiscal year.

Reference: Attachment 4.19-B Section 12, page 4

---

TN. No: 14-006  
Supersedes  
TN. No: 13-034

Approval Date: 06-27-14

Eff. Date: 1/1/2014

State Plan Under Title XIX of the Social Security Act  
Medical Assistance Program  
State: North Carolina

Payments for Medical and Remedial Care and Services

---

Payment for Chiropractic Services:

SFY 2004 – No adjustment. Chiropractor Fees

SFY 2005 and 2006 – No rate increase from the June 30, 2005 rate for all Medicaid private and public providers with the following exceptions: federally qualified health clinics, rural health centers, state institutions, outpatient hospital, pharmacy and the non-inflationary components of the case-mix reimbursement system for nursing facilities.

NC General Assembly legislation mandates that effective July 1, 2005, reimbursement rates for Chiropractic Fees for the state fiscal years 2005-2006 and 2006-2007 will remain at the rate in effect as of June 30, 2005 except Medicaid rates may be adjusted downward in accordance with the current year's downward adjustments to the Medicare fee schedule.

SFY 2007 - Effective January 1, 2007 an inflationary increase of 5.171% was applied.

SFY 2010 –The rates for SFY 2010 are frozen as of the rates in effect at July 1, 2009, except Medicaid rates may be adjusted downward in accordance with the current years downward adjustments to the Medicare fee schedule. Effective October 1, 2009, an overall negative rate adjustment of 4.90% was applied. There will be no further annual rate adjustment for SFY 2010.

SFY 2011 – The rates for SFY 2011 will be frozen at the rates in effect on June 30, 2010.

SFY 2012 – Rates will be frozen at the rate in effect on June 30, 2011. Effective November 1, 2011, existing rates are adjusted by a negative 2.67% to yield a twelve (12) month two percent (2%) reduction in the nine (9) remaining months of this State Fiscal Year.

SFY 2013 – Effective July 1, 2012, the rates will be adjusted such that they will equal 98% of the rate in effect July 1, 2011. There will be no further annual adjustments this state fiscal year except that Medicaid rates may be adjusted downward in accordance with the current years downward adjustments to the Medicare fee schedule. Rates for new codes will not include inflation beyond 2009.

SFY 2014 – Effective August 1, 2013, rates will be frozen at the rate in effect June 30, 2013. Effective January 1, 2014 rates will be adjusted such that they will equal 97% of the rate in effect July 1, 2013. There will be no further annual adjustments this state fiscal year except that Medicaid rates may be adjusted downward in accordance with the current years downward adjustments to the Medicare fee schedule. Rates for new codes will not include inflation beyond 2009.

SFY 2015- Effective July 1, 2014, the rates are frozen at the rate in effect as of June 30, 2014. There will be no further annual rate adjustment.

Reference: Attachment 4.19-B, Section 6, Page 1b

---

TN-No: 14-007  
Supersedes  
TN- No. 13-035

Approval Date:06-27-14

Eff. Date: 01/01/2014



State Plan Under Title XIX of the Social Security Act  
Medical Assistance Program  
State: North Carolina

Payments for Medical and Remedial Care and Services

---

Payment for Podiatry Services:

SFY 2004 – No adjustment. Podiatry Fees

SFY 2005 and 2006 – No rate increase from the June 30, 2005 rate for all Medicaid private and public providers with the following exceptions: federally qualified health clinics, rural health centers, state institutions, outpatient hospital, pharmacy and the non-inflationary components of the case-mix reimbursement system for nursing facilities.

NC General Assembly legislation mandates that effective July 1, 2005, reimbursement rates for Podiatry Fees for the state fiscal years 2005-2006 and 2006-2007 will remain at the rate in effect as of June 30, 2005 except Medicaid rates may be adjusted downward in accordance with the current year's downward adjustments to the Medicare fee schedule.

SFY 2007 - Effective January 1, 2007 an inflationary increase of 5.171% was applied.

SFY 2010 –The rates for SFY 2010 are frozen as of the rates in effect at July 1, 2009, except Medicaid rates may be adjusted downward in accordance with the current years downward adjustments to the Medicare fee schedule. Effective October 1, 2009, an overall negative rate adjustment of 4.90% was applied. There will be no further annual rate adjustment for SFY 2010.

SFY 2011 – The rates for SFY 2011 will be frozen at the rates in effect on June 30, 2010.

SFY 2012 – Rates will be frozen at the rate in effect on June 30, 2011. Effective November 1, 2011, existing rates are adjusted by a negative 2.67% to yield a twelve (12) month two percent (2%) reduction in the nine (9) remaining months of this State Fiscal Year.

SFY 2013 – Effective July 1, 2012, the rates will be adjusted such that they will equal 98% of the rate in effect July 1, 2011. There will be no further annual adjustments this state fiscal year except that Medicaid rates may be adjusted downward in accordance with the current years downward adjustments to the Medicare fee schedule. Rates for new codes will not include inflation beyond 2009.

SFY 2014 – Effective August 1, 2013, rates will be frozen at the rate in effect on June 30, 2013. Effective January 1, 2014 rates will be adjusted such that they will equal 97% of the rate in effect July 1, 2013. There will be no further annual adjustments this state fiscal year except that Medicaid rates may be adjusted downward in accordance with the current years downward adjustments to the Medicare fee schedule. Rates for new codes will not include inflation beyond 2009.

SFY 2015- Effective July 1, 2014, the rates are frozen at the rate in effect as of June 30, 2014. There will be no further annual rate adjustment.

Reference: Attachment 4.19-B, Section 6, Page 1

---

TN-No: 14-007  
Supersedes  
TN- No. 13-035

Approval Date: 06-27-14

Eff. Date: 01/01/2014

State Plan Under Title XIX of the Social Security Act  
Medical Assistance Program  
State: North Carolina

Payments for Medical and Remedial Care and Services

---

Payment for Optometry Services:

SFY 2004 – No adjustment. Optometrist Fees

SFY 2005 and 2006 – No rate increase from the June 30, 2005 rate for all Medicaid private and public providers with the following exceptions: federally qualified health clinics, rural health centers, state institutions, outpatient hospital, pharmacy and the non-inflationary components of the case-mix reimbursement system for nursing facilities.

NC General Assembly legislation mandates that effective July 1, 2005, reimbursement rates for Optometry Fees for the state fiscal years 2005-2006 and 2006-2007 will remain at the rate in effect as of June 30, 2005 except Medicaid rates may be adjusted downward in accordance with the current year's downward adjustments to the Medicare fee schedule.

SFY 2007 - Effective January 1, 2007 an inflationary increase of 5.171% was applied.

SFY 2010 –The rates for SFY 2010 are frozen as of the rates in effect at July 1, 2009, except Medicaid rates may be adjusted downward in accordance with the current years downward adjustments to the Medicare fee schedule. Effective October 1, 2009, an overall negative rate adjustment of 4.90% was applied. There will be no further annual rate adjustment for SFY 2010.

SFY 2011 – The rates for SFY 2011 will be frozen at the rates in effect on June 30, 2010.

SFY 2012 Rates will be frozen at the rate in effect on June 30, 2011. Effective November 1, 2011, existing rates are adjusted by a negative 2.64% to yield a twelve (12) month two percent (2%) reduction in the nine (9) remaining months of this State Fiscal Year.

SFY 2013 – Effective July 1, 2012, the rates will be adjusted such that they will equal 98% of the rate in effect July 1, 2011. There will be no further annual adjustments this state fiscal year except that Medicaid rates may be adjusted downward in accordance with the current years downward adjustments to the Medicare fee schedule. Rates for new codes will not include inflation beyond 2009.

SFY 2014 – Effective August 1, 2013, rates will be frozen at the rate in effect on June 30, 2013. Effective January 1, 2014 rates will be adjusted such that they will equal 97% of the rate in effect July 1, 2013. There will be no further annual adjustments this state fiscal year except that Medicaid rates may be adjusted downward in accordance with the current years downward adjustments to the Medicare fee schedule. Rates for new codes will not include inflation beyond 2009.

SFY 2015- Effective July 1, 2014, the rates are frozen at the rate in effect as of June 30, 2014. There will be no further annual rate adjustment.

---

Reference: Attachment 4.19-B, Section 6, Page 1a

TN-No: 14-007  
Supersedes  
TN- No. 13-035

Approval Date: 06-27-14

Eff. Date: 01/01/2014

State Plan Under Title XIX of the Social Security Act  
Medical Assistance Program  
State: North Carolina

Payments for Medical and Remedial Care and Services

---

Payment for Nurse Practitioner Services:

SFY 2012 – Rates will be frozen at the rate in effect on June 30, 2011. There will be no further annual adjustments this state fiscal year except that Medicaid rates may be adjusted downward in accordance with the current years downward adjustments to the Medicare fee schedule. Rates for new codes will not include inflation beyond 2009.

SFY 2013 – Rates will be frozen at the rate in effect on June 30, 2012. There will be no further annual adjustments this state fiscal year except that Medicaid rates may be adjusted downward in accordance with the current years downward adjustments to the Medicare fee schedule. Rates for new codes will not include inflation beyond 2009. Thereafter, the rate shall be reviewed annually, not later than March 1<sup>st</sup> of each succeeding calendar year.

SFY 2014 – Effective August 1, 2013, the rates are frozen as of the rate in effect at June 30, 2013. Effective January 1, 2014, the rates will be reimbursed at 100% of the current Medicaid physician fee schedule. There will be no further annual adjustments this state fiscal year except that Medicaid rates may be adjusted downward in accordance with the current years downward adjustments to the Medicare fee schedule.

SFY 2015 – Effective July 1, 2014, the rates will be reimbursed at 100% of the current Medicaid physician fee schedule. There will be no further annual adjustments this state fiscal year except that Medicaid rates may be adjusted downward in accordance with the current years downward adjustments to the Medicare fee schedule.

Reference: Attachment 4.19-B, Section 6, Page 1c

State Plan Under Title XIX of the Social Security Act  
Medical Assistance Program  
State: North Carolina

Payments for Medical and Remedial Care and Services

---

Payment for Independent Practitioner Services:

SFY 2004 – No adjustment. Other Independent Practitioner Fees

SFY 2005 and 2006 – No rate increase from the June 30, 2005 rate for all Medicaid private and public providers with the following exceptions: federally qualified health clinics, rural health centers, state institutions, outpatient hospital, pharmacy and the non-inflationary components of the case-mix reimbursement system for nursing facilities.

NC General Assembly legislation mandates that effective July 1, 2005, reimbursement rates for Independent Practitioner Fees for the state fiscal years 2005-2006 and 2006-2007 will remain at the rate in effect as of June 30, 2005 except Medicaid rates may be adjusted downward in accordance with the current year's downward adjustments to the Medicare fee schedule.

SFY 2007 - Effective January 1, 2007 an inflationary increase of 5.171% was applied.

SFY 2010 –The rates for SFY 2010 are frozen as of the rates in effect at July 1, 2009, except Medicaid rates may be adjusted downward in accordance with the current years downward adjustments to the Medicare fee schedule. Effective October 1, 2009, an overall negative rate adjustment of 4.90% was applied. There will be no further annual rate adjustment for SFY 2010.

SFY 2011 – The rates for SFY 2011 will be frozen at the rates in effect on June 30, 2010.

SFY 2012 – Rates will be frozen at the rate in effect on June 30, 2011. Effective November 1, 2011, existing rates are adjusted by a negative 2.66% to yield a twelve (12) month two percent (2%) reduction in the nine (9) remaining months of this State Fiscal Year.

SFY 2013 – Effective July 1, 2012, the rates will be adjusted such that they will equal 98% of the rate in effect July 1, 2011. There will be no further annual adjustments this state fiscal year except that Medicaid rates may be adjusted downward in accordance with the current years downward adjustments to the Medicare fee schedule. Rates for new codes will not include inflation beyond 2009.

SFY 2014 – Effective August 1, 2013, the rates are frozen as of the rate in effect at June 30, 2013. There will be no further annual adjustments this state fiscal year except that Medicaid rates may be adjusted downward in accordance with the current years downward adjustments to the Medicare fee schedule.

SFY 2015 – Effective July 1, 2014, the rates are frozen at the rate in effect as of June 30, 2014. There will be no further annual adjustments this state fiscal year except that Medicaid rates may be adjusted downward in accordance with the current years downward adjustments to the Medicare fee schedule.

Reference: Attachment 4.19-B, Section 6, Page 1d

---

TN-No: 13-030  
Supersedes  
TN- No. 11-014

Approval Date: 12-12-13

Eff. Date: 08-01-13

State Plan Under Title XIX of the Social Security Act  
Medical Assistance Program  
State: North Carolina

Payments for Medical and Remedial Care and Services

---

Payment for Other Licensed Practitioner Services::

SFY 2004 – No adjustment. Licensed Practitioner Services Fees

SFY 2005 and 2006 – No rate increase from the June 30, 2005 rate for all Medicaid private and public providers with the following exceptions: federally qualified health clinics, rural health centers, state institutions, outpatient hospital, pharmacy and the non-inflationary components of the case-mix reimbursement system for nursing facilities.

NC General Assembly legislation mandates that effective July 1, 2005, reimbursement rates for Licensed Practitioner Services Fees for the state fiscal years 2005-2006 and 2006-2007 will remain at the rate in effect as of June 30, 2005 except Medicaid rates may be adjusted downward in accordance with the current year's downward adjustments to the Medicare fee schedule.

SFY 2007 - Effective January 1, 2007 an inflationary increase of 5.171% was applied.

SFY 2010 – The rates for SFY 2010 are frozen as of the rates in effect at July 1, 2009, except Medicaid rates may be adjusted downward in accordance with the current years downward adjustments to the Medicare fee schedule. Effective October 1, 2009, an overall negative rate adjustment of 4.90% was applied. There will be no further annual rate adjustment for SFY 2010.

SFY 2011 – The rates for SFY 2011 will be frozen at the rates in effect on June 30, 2010.

SFY 2012 – Rates will be frozen at the rate in effect on June 30, 2011. Effective November 1, 2011, existing rates are adjusted by a negative 2.66% to yield a twelve (12) month two percent (2%) reduction in the nine (9) remaining months of this State Fiscal Year.

SFY 2013 – Effective July 1, 2012, the rates will be adjusted such that they will equal 98% of the rate in effect July 1, 2011. There will be no further annual adjustments this state fiscal year except that Medicaid rates may be adjusted downward in accordance with the current years downward adjustments to the Medicare fee schedule. Rates for new codes will not include inflation beyond 2009.

Reference: Attachment 4.19-B, Section 6, Page 1e

---

TN-No: 11-014  
Supersedes  
TN- No. NEW

Approval Date: 10-31-11

Eff. Date: 11/1/2011

State Plan Under Title XIX of the Social Security Act  
Medical Assistance Program  
State: North Carolina

Payments for Medical and Remedial Care and Services

---

Payment for Hearing Aids:

SFY 2004 – No adjustment. Hearing Aid Fees

SFY 2005 and 2006 – No rate increase from the June 30, 2005 rate for all Medicaid private and public providers with the following exceptions: federally qualified health clinics, rural health centers, state institutions, outpatient hospital, pharmacy and the non-inflationary components of the case-mix reimbursement system for nursing facilities.

NC General Assembly legislation mandates that effective July 1, 2005, reimbursement rates for Hearing Aids for the state fiscal years 2005-2006 and 2006-2007 will remain at the rate in effect as of June 30, 2005 except Medicaid rates may be adjusted downward in accordance with the current year's downward adjustments to the Medicare fee schedule.

SFY 2007 - Effective January 1, 2007 an inflationary increase of 5.171% was applied.

SFY 2010 –The rates for SFY 2010 are frozen as of the rates in effect at July 1, 2009, except Medicaid rates may be adjusted downward in accordance with the current years downward adjustments to the Medicare fee schedule. Effective October 1, 2009, an overall negative rate adjustment of 4.90% was applied. There will be no further annual rate adjustment for SFY 2010.

SFY 2011 – The rates for SFY 2011 will be frozen at the rates in effect on June 30, 2010.

SFY 2012 – Rates will be frozen at the rate in effect on June 30, 2011. Effective November 1, 2011, existing rates are adjusted by a negative 2.67% to yield a twelve (12) month two percent (2%) reduction in the nine (9) remaining months of this State Fiscal Year.

SFY 2013 – Effective July 1, 2012, the rates will be adjusted such that they will equal 98% of the rate in effect July 1, 2011. There will be no further annual adjustments this state fiscal year except that Medicaid rates may be adjusted downward in accordance with the current years downward adjustments to the Medicare fee schedule.

SFY 2014 – Effective August 1, 2013, rates will be frozen at the rate in effect on June 30, 2013. Effective January 1, 2014 rates will be adjusted such that they will equal 97% of the rate in effect July 1, 2013. There will be no further annual adjustments this state fiscal year except that Medicaid rates may be adjusted downward in accordance with the current years downward adjustments to the Medicare fee schedule.

SFY 2015- Effective July 1, 2014, the rates are frozen at the rate in effect as of June 30, 2014. There will be no further annual rate adjustment.

Reference: Attachment 4.19-B, Section 4, Page 2a

---

TN-No: 14-005  
Supersedes  
TN-No: 13-036

Approval Date:06-27-14

Eff. Date: 01/01/2014

State Plan Under Title XIX of the Social Security Act  
Medical Assistance Program  
State: North Carolina

Payments for Medical and Remedial Care and Services

---

Payment for Physician Assistant Services:

SFY 2014 - Effective August 1, 2013, the rates will be frozen at the rates in effect on June 30, 2013. Effective January 1, 2014, the rates will be reimbursed at 100% of the current Medicaid physician fee schedule. There will be no further annual rate adjustment except Medicaid rates may be adjusted downward in accordance with the current year's downward adjustments to the Medicare fee schedule.

SFY 2015 - Effective July 1, 2014, the rates will be reimbursed at 100% of the current Medicaid physician fee schedule. There will be no further annual rate adjustment except Medicaid rates may be adjusted downward in accordance with the current year's downward adjustments to the Medicare fee schedule.

Reference: Attachment 4.19-B, Section 5, Page 1f

---

TN-No: 14-012  
Supersedes  
TN- No. 13-023

Approval Date 06-27-14

Eff. Date: 01/01/2014

MEDICAL ASSISTANCE  
State: NORTH CAROLINA

PAYMENTS FOR MEDICAL AND REMEDIAL CARE AND SERVICE

---

Payment for Physician Drug Program:

SFY 2010 – The rates for SFY 2010 are frozen as of the rates in effect at July 1, 2009. Effective October 1, 2009, a negative inflationary adjustment of 3.61% was applied to the existing rates. There will be no further annual adjustment.

SFY 2011 – As of July 1, 2010 rates will be frozen except Medicaid rates may be adjusted downward in accordance with the current years downward adjustments to the Medicare fee schedule.

SFY 2012 - The rates for SFY 2012 are frozen as of the rates in effect at July 1, 2011 except Medicaid rates may be adjusted downward in accordance with the current years downward adjustments to the Medicare fee schedule.

SFY 2014 – Effective August 1, 2013, the rates will be frozen at the rate in effect on June 30, 2013. There will be no further annual adjustments except that Medicaid rates may be adjusted downward in accordance with the applicable years downward adjustments to the Medicare fee schedule.

SFY 2015 - Effective July 1, 2014, the rates will be frozen at the rate in effect on June 30, 2014. Effective January 1, 2015, the rates will be adjusted such that they will equal 99% of the rate in effect December 31, 2014. There will be no further annual adjustments except that Medicaid rates may be adjusted downward in accordance with the applicable years downward adjustments to the Medicare fee schedule.

Reference: Attachment 4.19-B, Section 12

---

TN No.: 14-021  
Supersedes  
TN No.: 13-026

Approval Date: 12-12-14

Effective Date: 07/01/14



State Plan Under Title XIX of the Social Security Act  
Medical Assistance Program  
State: North Carolina

Payments for Medical and Remedial Care and Services

---

Payment for Orthotics and Prosthetics:

SFY 2004 – No adjustment.

SFY 2005 and 2006 – No rate increase from the June 30, 2005 rate for all Medicaid private and public providers with the following exceptions: federally qualified health clinics, rural health centers, state institutions, outpatient hospital, pharmacy and the non-inflationary components of the case-mix reimbursement system for nursing facilities.

NC General Assembly legislation mandates that effective July 1, 2005, reimbursement rates for these programs (Orthotics and Prosthetics) for the state fiscal years 2005-2006 and 2006-2007 will remain at the rate in effect as of June 30, 2005, except Medicaid rates may be adjusted downward in accordance with the current year's downward adjustments to the Medicare fee schedule.

SFY 2007 - Inflationary increase of 2.05% was applied to the Orthotics and Prosthetics program.

SFY 2009 - The rates for Orthotics and Prosthetics are frozen at the rates in effect on June 30, 2008.

SFY 2010 – Effective October 1, 2009, an overall negative rate adjustment of 4.15% was applied. There will be no further annual rate adjustment for SFY 2010.

SFY 2011 - As of July 1, 2010 rates will be frozen.

SFY 2012 – Rates will be frozen at the rate in effect on June 30, 2011. Effective November 1, 2011, existing rates are adjusted by a negative 2.67% to yield a twelve (12) month two percent (2%) reduction in the nine (9) remaining months of this State Fiscal Year.

SFY 2013 – Effective July 1, 2012, the rates will be adjusted such that they will equal 98% of the rate in effect July 1, 2011. There will be no further annual adjustments this state fiscal year except that Medicaid rates may be adjusted downward in accordance with the current years downward adjustments to the Medicare fee schedule.

SFY 2014 – As of August 1, 2013 rates will be frozen as in effect June 30, 2013. There will be no further adjustments except that Medicaid rates may be adjusted downward in accordance with the applicable years downward adjustments to the Medicare fee schedule.

SFY 2015 - As of July 1, 2014 rates will be frozen as in effect June 30, 2014. There will be no further adjustments except that Medicaid rates may be adjusted downward in accordance with the applicable years downward adjustments to the Medicare fee schedule.

Reference: Attachment 4.19-B Section 12, Page 3

---

TN. No: 13-021  
Supersedes  
TN. No: 11-018

Approval Date 12-11-13

Eff. Date 08/01/2013

State Plan Under Title XIX of the Social Security Act  
Medical Assistance Program  
State: North Carolina

Payments for Medical and Remedial Care and Services

---

Payment for Targeted Case Management for Adults and Children At-Risk For Abuse, Neglect, or Exploitation (ARCM):

SFY 2010 – The rates for SFY 2010 are frozen as of the rates in effect at July 1, 2009. Effective October 1, 2009, an overall negative rate adjustment of 9.807% was applied to Case Management rates. There will be no further annual adjustment.

SFY 2011 - As of July 1, 2010, rates will be frozen at the rates in effect on June 30, 2010.

SFY 2012 – Rates will be frozen at the rate in effect on June 30, 2011. Effective November 1, 2011, existing rates are adjusted by a negative 2.62% to yield a twelve (12) month two percent (2%) reduction in the nine (9) remaining months of this State Fiscal Year.

SFY 2013 – Effective July 1, 2012, the rates will be adjusted such that they will equal 98% of the rate in effect July 1, 2011. There will be no further annual adjustments this state fiscal year.

SFY 2014 – The rates will be frozen at the rates in effect on June 30, 2013. There will be no further annual adjustment.

SFY 2015 - Rates will be frozen at the rate in effect on June 30, 2014. There will be no further annual adjustments this state fiscal year.

Reference: Attachment 4.19-B, Section 19, Pages 2

---

TN No: 13-015  
Supersedes  
TN No: 11-017

Approval Date: 12-04-14

Eff. Date: 8/01/2013

State Plan Under Title XIX of the Social Security Act  
Medical Assistance Program  
State: North Carolina

Payments for Medical and Remedial Care and Services

---

Payment for Targeted Case Management for Children and Adults with Developmental Disabilities/  
Delay or Traumatic Brain Injury, Manifested Prior to Age 22 or Children with Special Health Care  
Needs

SFY 2012 – Rates will be frozen at the rate in effect on June 30, 2011. Effective November 1, 2011, existing rates are adjusted by a negative 2.67% to yield a twelve (12) month two percent (2%) reduction in the nine (9) remaining months of this State Fiscal Year.

SFY 2013 – Effective July 1, 2012, the rates will be adjusted such that they will equal 98% of the rate in effect July 1, 2011. There will be no further annual adjustments this state fiscal year.

SFY 2014 – The rates will be frozen at the rates in effect on June 30, 2013. There will be no further annual adjustment.

SFY 2015 - Rates will be frozen at the rate in effect on June 30, 2014. There will be no further annual adjustments this state fiscal year.

Reference: Attachment 4.19-B, Section 19, Pages 3

---

TN No: 13-017  
Supersedes  
TN No: 11-022

Approval Date: 12-08-14

Eff. Date: 8/1/2013

State Plan Under Title XIX of the Social Security Act  
Medical Assistance Program  
State: North Carolina

Payments for Medical and Remedial Care and Services

---

Payment for Targeted Case Management For Children And Adults With Serious Emotional Disturbance, Or Severe And Persistent Mental Illness Or Substance Abuse Disorder:

SFY 2012 – The rates for SFY2012 are frozen as of the rates in effect at July 1, 2011. There will be no further annual adjustment.

SFY 2013 – The rates for SFY2013 are frozen as of the rates in effect at July 1, 2011. There will be no further annual adjustment.

SFY 2014 – The rates will be frozen at the rates in effect on June 30, 2013. There will be no further annual adjustment.

SFY 2015 - Rates will be frozen at the rate in effect on June 30, 2014. There will be no further annual adjustments this state fiscal year.

Reference: Attachment 4.19-B, Section 19, Page 6

---

TN No: 13-016  
Supersedes  
TN No: 11-030

Approval Date: 12-11-14

Eff. Date: 8/1/2013

State Plan Under Title XIX of the Social Security Act  
Medical Assistance Program  
State: North Carolina

Payments for Medical and Remedial Care and Services

---

Payment for Case Management (Persons With HIV Disease):

SFY 2012 – Rates will be frozen at the rate in effect on June 30, 2011. Effective November 1, 2011, existing rates are adjusted by a negative 2.67% to yield a twelve (12) month two percent (2%) reduction in the nine (9) remaining months of this State Fiscal Year.

SFY 2013 – Effective July 1, 2012, the rates will be adjusted such that they will equal 98% of the rate in effect July 1, 2011. There will be no further annual adjustments this state fiscal year.

SFY 2014 – Effective August 1, 2013, the rates will be frozen at the rate in effect on June 30, 2013. There will be no further annual adjustments except that Medicaid rates may be adjusted downward in accordance with the applicable years downward adjustments to the Medicare fee schedule.

SFY 2015- Effective August 1, 2013, the rates will be frozen at the rate in effect on June 30, 2013. There will be no further annual adjustments except that Medicaid rates may be adjusted downward in accordance with the applicable years downward adjustments to the Medicare fee schedule.

Reference: Attachment 4.19-B, Section 19, Page 5

---

TN No: 13-024  
Supersedes  
TN No: 12-008

Approval Date: 12-11-13

Eff. Date: 08-01-2013

State Plan Under Title XIX of the Social Security Act  
Medical Assistance Program  
State: North Carolina

Payments for Medical and Remedial Care and Services

---

Payment for Medically Monitored or Alcohol Drug Addiction Treatment Center  
Detoxification/Crisis Stabilization (Adult – H2036):

Intentionally Left Blank

---

TN No: 11-034  
Supersedes  
TN No: NEW

Approval Date: 03-05-12

Effective Date: 11/01/2011

State Plan Under Title XIX of the Social Security Act  
Medical Assistance Program  
State: North Carolina

Payments for Medical and Remedial Care and Services

---

Payment for Multi Systemic Therapy:

SFY 2011 – The rates for SFY2011 are frozen as of the rates in effect at July 1, 2010. There will be no further annual adjustment.

SFY 2012 – Rates will be frozen at the rate in effect on June 30, 2011. Effective November 1, 2011, existing rates are adjusted by a negative 2.65% to yield a twelve (12) month two percent (2%) reduction in the nine (9) remaining months of this State Fiscal Year.

SFY 2013 – Effective July 1, 2012, the rates will be adjusted such that they will equal 98% of the rate in effect July 1, 2011. There will be no further annual adjustments this state fiscal year.

SFY 2014 – The rates will be frozen at the rates in effect on June 30, 2013. There will be no further annual adjustment.

SFY 2015 - Rates will be frozen at the rate in effect on June 30, 2014. There will be no further annual adjustments this state fiscal year.

Reference: Attachment 4.19-B, Section 13, Page 2

---

TN No: 13-018  
Supersedes  
TN No: 11-034

Approval Date: 12-11-13

Effective Date: 8/1/2013

State Plan Under Title XIX of the Social Security Act  
Medical Assistance Program  
State: North Carolina

Payments for Medical and Remedial Care and Services

---

Payment for Ambulatory Detoxification:

SFY 2011 – The rates for SFY2011 are frozen as of the rates in effect at July 1, 2010. There will be no further annual adjustment.

SFY 2012 – Rates will be frozen at the rate in effect on June 30, 2011. Effective November 1, 2011, existing rates are adjusted by a negative 2.65% to yield a twelve (12) month two percent (2%) reduction in the nine (9) remaining months of this State Fiscal Year.

SFY 2013 – Effective July 1, 2012, the rates will be adjusted such that they will equal 98% of the rate in effect July 1, 2011. There will be no further annual adjustments this state fiscal year.

SFY 2014 – The rates will be frozen at the rates in effect on June 30, 2013. There will be no further annual adjustment.

SFY 2015 - Rates will be frozen at the rate in effect on June 30, 2014. There will be no further annual adjustments this state fiscal year.

Reference: Attachment 4.19-B, Section 13, Page 3

---

TN No: 13-018  
Supersedes  
TN No: 11-034

Approval Date: 12-11-13

Effective Date: 8/1/2013



State Plan Under Title XIX of the Social Security Act  
Medical Assistance Program  
State: North Carolina

Payments for Medical and Remedial Care and Services

---

Payment for Professional Treatment Services in Facility Based Crisis Programs - Adult:

SFY 2011 – The rates for SFY2011 are frozen as of the rates in effect at July 1, 2010. There will be no further annual adjustment.

SFY 2012 – Rates will be frozen at the rate in effect on June 30, 2011. Effective November 1, 2011, existing rates are adjusted by a negative 2.65% to yield a twelve (12) month two percent (2%) reduction in the nine (9) remaining months of this State Fiscal Year.

SFY 2013 – Effective July 1, 2012, the rates will be adjusted such that they will equal 98% of the rate in effect July 1, 2011. There will be no further annual adjustments this state fiscal year.

SFY 2014 – The rates will be frozen at the rates in effect on June 30, 2013. There will be no further annual adjustment.

SFY 2015 - Rates will be frozen at the rate in effect on June 30, 2014. There will be no further annual adjustments this state fiscal year.

Reference: Attachment 4.19-B, Section 13, Page 4

---

TN No: 13-018  
Supersedes  
TN No: 11-034

Approval Date: 12-11-13

Effective Date: 8/1/2013

State Plan Under Title XIX of the Social Security Act  
Medical Assistance Program  
State: North Carolina

Payments for Medical and Remedial Care and Services

---

Payment for Facility-Based Crisis Program – Children and Adolescents:

SFY 2011 – The rates for SFY2011 are frozen as of the rates in effect at July 1, 2010. There will be no further annual adjustment.

SFY 2012 – Rates will be frozen at the rate in effect on June 30, 2011. Effective November 1, 2011, existing rates are adjusted by a negative 2.65% to yield a twelve (12) month two percent (2%) reduction in the nine (9) remaining months of this State Fiscal Year.

SFY 2013 – Effective July 1, 2012, the rates will be adjusted such that they will equal 98% of the rate in effect July 1, 2011. There will be no further annual adjustments this state fiscal year.

SFY 2014 – The rates will be frozen at the rates in effect on June 30, 2013. There will be no further annual adjustment.

SFY 2015 - Rates will be frozen at the rate in effect on June 30, 2014. There will be no further annual adjustments this state fiscal year.

Reference: Attachment 4.19-B, Section 13, Page 5

---

TN No: 13-018  
Supersedes  
TN No: 11-034

Approval Date: 12-11-13

Effective Date: 8/1/2013

State Plan Under Title XIX of the Social Security Act  
Medical Assistance Program  
State: North Carolina

Payments for Medical and Remedial Care and Services

---

Payment for Substance Abuse Comprehensive Outpatient Treatment program:

SFY 2011 – The rates for SFY2011 are frozen as of the rates in effect at July 1, 2010. There will be no further annual adjustment.

SFY 2012 – Rates will be frozen at the rate in effect on June 30, 2011. Effective November 1, 2011, existing rates are adjusted by a negative 2.65% to yield a twelve (12) month two percent (2%) reduction in the nine (9) remaining months of this State Fiscal Year.

SFY 2013 – Effective July 1, 2012, the rates will be adjusted such that they will equal 98% of the rate in effect July 1, 2011. There will be no further annual adjustments this state fiscal year.

SFY 2014 – The rates will be frozen at the rates in effect on June 30, 2013. There will be no further annual adjustment.

SFY 2015 - Rates will be frozen at the rate in effect on June 30, 2014. There will be no further annual adjustments this state fiscal year.

Reference: Attachment 4.19-B, Section 13, Page 6

---

TN No: 13-018  
Supersedes  
TN No: 11-034

Approval Date: 12-11-13

Effective Date: 8/1/2013

State Plan Under Title XIX of the Social Security Act  
Medical Assistance Program  
State: North Carolina

Payments for Medical and Remedial Care and Services

---

Payment for Intensive In-Home Services:

SFY 2011 – The rates for SFY2011 are frozen as of the rates in effect at July 1, 2010. There will be no further annual adjustment.

SFY 2012 – The rates for SFY2012 are frozen as of the rates in effect at July 1, 2010. There will be no further annual adjustment.

SFY 2013 – The rates for SFY2013 are frozen as of the rates in effect at July 1, 2010. There will be no further annual adjustment.

SFY 2014 – The rates will be frozen at the rates in effect on June 30, 2013. There will be no further annual adjustment.

SFY 2015 - Rates will be frozen at the rate in effect on June 30, 2014. There will be no further annual adjustments this state fiscal year.

Reference: Attachment 4.19-B, Section 13, Page 7

---

TN No: 13-018  
Supersedes  
TN No: 11-034

Approval Date: 12-11-13

Effective Date: 8/1/2013

State Plan Under Title XIX of the Social Security Act  
Medical Assistance Program  
State: North Carolina

Payments for Medical and Remedial Care and Services

---

Payment for Substance Abuse Intensive Outpatient Program:

SFY 2011 – The rates for SFY2011 are frozen as of the rates in effect at July 1, 2010. There will be no further annual adjustment.

SFY 2012 – Rates will be frozen at the rate in effect on June 30, 2011. Effective November 1, 2011, existing rates are adjusted by a negative 2.65% to yield a twelve (12) month two percent (2%) reduction in the nine (9) remaining months of this State Fiscal Year.

SFY 2013 – Effective July 1, 2012, the rates will be adjusted such that they will equal 98% of the rate in effect July 1, 2011. There will be no further annual adjustments this state fiscal year.

SFY 2014 – The rates will be frozen at the rates in effect on June 30, 2013. There will be no further annual adjustment.

SFY 2015 - Rates will be frozen at the rate in effect on June 30, 2014. There will be no further annual adjustments this state fiscal year.

Reference: Attachment 4.19-B, Section 13, Page 8

---

TN No: 13-018  
Supersedes  
TN No: 11-034

Approval Date: 12-11-13

Effective Date: 8/1/2013

State Plan Under Title XIX of the Social Security Act  
Medical Assistance Program  
State: North Carolina

Payments for Medical and Remedial Care and Services

---

Payment for Substance Abuse Non-medical Community Residential Treatment:

SFY 2011 – The rates for SFY2011 are frozen as of the rates in effect at July 1, 2010. There will be no further annual adjustment.

SFY 2012 – Rates will be frozen at the rate in effect on June 30, 2011. Effective November 1, 2011, existing rates are adjusted by a negative 2.65% to yield a twelve (12) month two percent (2%) reduction in the nine (9) remaining months of this State Fiscal Year.

SFY 2013 – Effective July 1, 2012, the rates will be adjusted such that they will equal 98% of the rate in effect July 1, 2011. There will be no further annual adjustments this state fiscal year.

SFY 2014 – The rates will be frozen at the rates in effect on June 30, 2013. There will be no further annual adjustment.

SFY 2015 - Rates will be frozen at the rate in effect on June 30, 2014. There will be no further annual adjustments this state fiscal year.

Reference: Attachment 4.19-B, Section 13, Page 9

---

TN No: 13-018  
Supersedes  
TN No: 11-034

Approval Date: 12-11-13

Effective Date: 8/1/2013

State Plan Under Title XIX of the Social Security Act  
Medical Assistance Program  
State: North Carolina

Payments for Medical and Remedial Care and Services

---

Payment for Substance Abuse Medically Monitored Community Residential Treatment:

SFY 2011 – The rates for SFY2011 are frozen as of the rates in effect at July 1, 2010. There will be no further annual adjustment.

SFY 2012 – Rates will be frozen at the rate in effect on June 30, 2011. Effective November 1, 2011, existing rates are adjusted by a negative 2.65% to yield a twelve (12) month two percent (2%) reduction in the nine (9) remaining months of this State Fiscal Year.

SFY 2013 – Effective July 1, 2012, the rates will be adjusted such that they will equal 98% of the rate in effect July 1, 2011. There will be no further annual adjustments this state fiscal year.

SFY 2014 – The rates will be frozen at the rates in effect on June 30, 2013. There will be no further annual adjustment.

SFY 2015 - Rates will be frozen at the rate in effect on June 30, 2014. There will be no further annual adjustments this state fiscal year.

Reference: Attachment 4.19-B, Section 13, Page 10

---

TN No: 13-018  
Supersedes  
TN No: 11-034

Approval Date: 12-11-13

Effective Date: 8/1/2013

State Plan Under Title XIX of the Social Security Act  
Medical Assistance Program  
State: North Carolina

Payments for Medical and Remedial Care and Services

---

Payment for Non Hospital Medical Detoxification:

SFY 2011 – The rates for SFY2011 are frozen as of the rates in effect at July 1, 2010. There will be no further annual adjustment.

SFY 2012 – Rates will be frozen at the rate in effect on June 30, 2011. Effective November 1, 2011, existing rates are adjusted by a negative 2.65% to yield a twelve (12) month two percent (2%) reduction in the nine (9) remaining months of this State Fiscal Year.

SFY 2013 – Effective July 1, 2012, the rates will be adjusted such that they will equal 98% of the rate in effect July 1, 2011. There will be no further annual adjustments this state fiscal year.

SFY 2014 – The rates will be frozen at the rates in effect on June 30, 2013. There will be no further annual adjustment.

SFY 2015 - Rates will be frozen at the rate in effect on June 30, 2014. There will be no further annual adjustments this state fiscal year.

Reference: Attachment 4.19-B, Section 13, Page 11

---

TN No: 13-018  
Supersedes  
TN No: 11-034

Approval Date: 12-11-13

Effective Date: 8/1/2013



State Plan Under Title XIX of the Social Security Act  
Medical Assistance Program  
State: North Carolina

Payments for Medical and Remedial Care and Services

---

Payment for Partial Hospital:

SFY 2011 – The rates for SFY2011 are frozen as of the rates in effect at July 1, 2010. There will be no further annual adjustment.

SFY 2012 – Rates will be frozen at the rate in effect on June 30, 2011. Effective November 1, 2011, existing rates are adjusted by a negative 2.65% to yield a twelve (12) month two percent (2%) reduction in the nine (9) remaining months of this State Fiscal Year.

SFY 2013 – Effective July 1, 2012, the rates will be adjusted such that they will equal 98% of the rate in effect July 1, 2011. There will be no further annual adjustments this state fiscal year.

SFY 2014 – The rates will be frozen at the rates in effect on June 30, 2013. There will be no further annual adjustment.

SFY 2015 - Rates will be frozen at the rate in effect on June 30, 2014. There will be no further annual adjustments this state fiscal year.

Reference: Attachment 4.19-B, Section 13, Page 12

---

TN No: 13-018  
Supersedes  
TN No: 11-034

Approval Date: 12-11-13

Effective Date: 8/1/2013

State Plan Under Title XIX of the Social Security Act  
Medical Assistance Program  
State: North Carolina

Payments for Medical and Remedial Care and Services

---

Payment for Assertive Community Treatment Team (ACTT):

SFY 2011 – The rates for SFY2011 are frozen as of the rates in effect at July 1, 2010. There will be no further annual adjustment.

SFY 2012 – Rates will be frozen at the rate in effect on June 30, 2011. Effective November 1, 2011, existing rates are adjusted by a negative 2.65% to yield a twelve (12) month two percent (2%) reduction in the nine (9) remaining months of this State Fiscal Year.

SFY 2013 – Effective July 1, 2012, the rates will be adjusted such that they will equal 98% of the rate in effect July 1, 2011. There will be no further annual adjustments this state fiscal year.

SFY 2014 – The rates will be frozen at the rates in effect on June 30, 2013. There will be no further annual adjustment.

SFY 2015 - Rates will be frozen at the rate in effect on June 30, 2014. There will be no further annual adjustments this state fiscal year.

Reference: Attachment 4.19-B, Section 13, Page 13

---

TN No: 13-018  
Supersedes  
TN No: 11-034

Approval Date: 12-11-13

Effective Date: 8/1/2013

State Plan Under Title XIX of the Social Security Act  
Medical Assistance Program  
State: North Carolina

Payments for Medical and Remedial Care and Services

---

Payment for Diagnostic Assessment:

SFY 2011 – The rates for SFY2011 are frozen as of the rates in effect at July 1, 2010. There will be no further annual adjustment.

SFY 2012 – Rates will be frozen at the rate in effect on June 30, 2011. Effective November 1, 2011, existing rates are adjusted by a negative 2.65% to yield a twelve (12) month two percent (2%) reduction in the nine (9) remaining months of this State Fiscal Year.

SFY 2013 – Effective July 1, 2012, the rates will be adjusted such that they will equal 98% of the rate in effect July 1, 2011. There will be no further annual adjustments this state fiscal year.

SFY 2014 – The rates will be frozen at the rates in effect on June 30, 2013. There will be no further annual adjustment.

SFY 2015 - Rates will be frozen at the rate in effect on June 30, 2014. There will be no further annual adjustments this state fiscal year.

Reference: Attachment 4.19-B, Section 13, Page 14

---

TN No: 13-018  
Supersedes  
TN No: 11-034

Approval Date: 12-11-13

Effective Date: 8/1/2013

State Plan Under Title XIX of the Social Security Act  
Medical Assistance Program  
State: North Carolina

Payments for Medical and Remedial Care and Services

---

Payment for Opioid Treatment:

SFY 2011 – The rates for SFY2011 are frozen as of the rates in effect at July 1, 2010. There will be no further annual adjustment.

SFY 2012 – Rates will be frozen at the rate in effect on June 30, 2011. Effective November 1, 2011, existing rates are adjusted by a negative 2.65% to yield a twelve (12) month two percent (2%) reduction in the nine (9) remaining months of this State Fiscal Year.

SFY 2013 – Effective July 1, 2012, the rates will be adjusted such that they will equal 98% of the rate in effect July 1, 2011. There will be no further annual adjustments this state fiscal year.

SFY 2014 – The rates will be frozen at the rates in effect on June 30, 2013. There will be no further annual adjustment.

SFY 2015 - Rates will be frozen at the rate in effect on June 30, 2014. There will be no further annual adjustments this state fiscal year.

Reference: Attachment 4.19-B, Section 13, Page 15

---

TN No: 13-018  
Supersedes  
TN No: 11-034

Approval Date: 12-11-13

Effective Date: 8/1/2013

State Plan Under Title XIX of the Social Security Act  
Medical Assistance Program  
State: North Carolina

Payments for Medical and Remedial Care and Services

---

Payment for Psychosocial Rehabilitation:

SFY 2011 – The rates for SFY2011 are frozen as of the rates in effect at July 1, 2010. There will be no further annual adjustment.

SFY 2012 – Rates will be frozen at the rate in effect on June 30, 2011. Effective November 1, 2011, existing rates are adjusted by a negative 2.65% to yield a twelve (12) month two percent (2%) reduction in the nine (9) remaining months of this State Fiscal Year.

SFY 2013 – Effective July 1, 2012, the rates will be adjusted such that they will equal 98% of the rate in effect July 1, 2011. There will be no further annual adjustments this state fiscal year.

SFY 2014 – The rates will be frozen at the rates in effect on June 30, 2013. There will be no further annual adjustment.

SFY 2015 - Rates will be frozen at the rate in effect on June 30, 2014. There will be no further annual adjustments this state fiscal year.

Reference: Attachment 4.19-B, Section 13, Page 16

---

TN No: 13-018  
Supersedes  
TN No: 11-034

Approval Date: 12-11-13

Effective Date: 8/1/2013

State Plan Under Title XIX of the Social Security Act  
Medical Assistance Program  
State: North Carolina

Payments for Medical and Remedial Care and Services

---

Payment for Mobile Crisis Management:

SFY 2011 – The rates for SFY2011 are frozen as of the rates in effect at July 1, 2010. There will be no further annual adjustment.

SFY 2012 – Rates will be frozen at the rate in effect on June 30, 2011. Effective November 1, 2011, existing rates are adjusted by a negative 2.65% to yield a twelve (12) month two percent (2%) reduction in the nine (9) remaining months of this State Fiscal Year.

SFY 2013 – Effective July 1, 2012, the rates will be adjusted such that they will equal 98% of the rate in effect July 1, 2011. There will be no further annual adjustments this state fiscal year.

SFY 2014 – The rates will be frozen at the rates in effect on June 30, 2013. There will be no further annual adjustment.

SFY 2015 - Rates will be frozen at the rate in effect on June 30, 2014. There will be no further annual adjustments this state fiscal year.

Reference: Attachment 4.19-B, Section 13, Page 17

---

TN No: 13-018  
Supersedes  
TN No: 11-034

Approval Date: 12-11-13

Effective Date: 8/1/2013

State Plan Under Title XIX of the Social Security Act  
Medical Assistance Program  
State: North Carolina

Payments for Medical and Remedial Care and Services

---

Payment for Community Support Team:

SFY 2012 – The rates for SFY2012 are frozen as of the rates in effect at July 1, 2011. There will be no further annual adjustment.

SFY 2013 – The rates for SFY2013 are frozen as of the rates in effect at July 1, 2011. There will be no further annual adjustment.

SFY 2014 – The rates will be frozen at the rates in effect on June 30, 2013. There will be no further annual adjustment.

SFY 2015 - Rates will be frozen at the rate in effect on June 30, 2014. There will be no further annual adjustments this state fiscal year.

Reference: Attachment 4.19-B, Section 13, Page 18

---

TN No: 13-018  
Supersedes  
TN No: 11-034

Approval Date: 12-11-13

Effective Date: 8/1/2013

State Plan Under Title XIX of the Social Security Act  
Medical Assistance Program  
State: North Carolina

Payments for Medical and Remedial Care and Services

---

Payment for Child and Adolescent Day Treatment:

SFY 2011 – The rates for SFY2011 are frozen as of the rates in effect at July 1, 2010. There will be no further annual adjustment.

SFY 2012 – The rates for SFY2012 are frozen as of the rates in effect at July 1, 2010. There will be no further annual adjustment.

SFY 2013 – The rates for SFY2013 are frozen as of the rates in effect at July 1, 2010. There will be no further annual adjustment.

SFY 2014 – The rates will be frozen at the rates in effect on June 30, 2013. There will be no further annual adjustment.

SFY 2015 - Rates will be frozen at the rate in effect on June 30, 2014. There will be no further annual adjustments this state fiscal year.

Reference: Attachment 4.19-B, Section 13, Page 19

---

TN No: 13-018  
Supersedes  
TN No: 11-034

Approval Date: 12-11-13

Effective Date: 8/1/2013



State Plan Under Title XIX of the Social Security Act  
Medical Assistance Program  
State: North Carolina

Payments for Medical and Remedial Care and Services

---

Payment for High Risk Intervention – Level I:

SFY 2011 – The rates for SFY2011 are frozen as of the rates in effect at July 1, 2010. There will be no further annual adjustment.

SFY 2012 – Rates will be frozen at the rate in effect on June 30, 2011. Effective November 1, 2011, existing rates are adjusted by a negative 2.65% to yield a twelve (12) month two percent (2%) reduction in the nine (9) remaining months of this State Fiscal Year.

SFY 2013 – Effective July 1, 2012, the rates will be adjusted such that they will equal 98% of the rate in effect July 1, 2011. There will be no further annual adjustments this state fiscal year.

SFY 2014 – The rates will be frozen at the rates in effect on June 30, 2013. There will be no further annual adjustment.

SFY 2015 - Rates will be frozen at the rate in effect on June 30, 2014. There will be no further annual adjustments this state fiscal year.

Reference: Attachment 4.19-B, Section 13, Page 20

---

TN No: 13-018  
Supersedes  
TN No: 11-034

Approval Date: 12-11-13

Effective Date: 8/1/2013

State Plan Under Title XIX of the Social Security Act  
Medical Assistance Program  
State: North Carolina

Payments for Medical and Remedial Care and Services

---

Payment for High Risk Intervention – Level II Group Home:

SFY 2011 – The rates for SFY2011 are frozen as of the rates in effect at July 1, 2010. There will be no further annual adjustment.

SFY 2012 – Rates will be frozen at the rate in effect on June 30, 2011. Effective November 1, 2011, existing rates are adjusted by a negative 2.65% to yield a twelve (12) month two percent (2%) reduction in the nine (9) remaining months of this State Fiscal Year.

SFY 2013 – Effective July 1, 2012, the rates will be adjusted such that they will equal 98% of the rate in effect July 1, 2011. There will be no further annual adjustments this state fiscal year.

SFY 2014 – The rates will be frozen at the rates in effect on June 30, 2013. There will be no further annual adjustment.

SFY 2015 - Rates will be frozen at the rate in effect on June 30, 2014. There will be no further annual adjustments this state fiscal year.

Reference: Attachment 4.19-B, Section 13, Page 21

---

TN No: 13-018  
Supersedes  
TN No: 11-034

Approval Date: 12-11-13

Effective Date: 8/1/2013

State Plan Under Title XIX of the Social Security Act  
Medical Assistance Program  
State: North Carolina

Payments for Medical and Remedial Care and Services

---

Payment for High Risk Intervention – Level II Family Setting:

SFY 2011 – The rates for SFY2011 are frozen as of the rates in effect at July 1, 2010. There will be no further annual adjustment.

SFY 2012 – Rates will be frozen at the rate in effect on June 30, 2011. Effective November 1, 2011, existing rates are adjusted by a negative 2.65% to yield a twelve (12) month two percent (2%) reduction in the nine (9) remaining months of this State Fiscal Year.

SFY 2013 – Effective July 1, 2012, the rates will be adjusted such that they will equal 98% of the rate in effect July 1, 2011. There will be no further annual adjustments this state fiscal year.

SFY 2014 – The rates will be frozen at the rates in effect on June 30, 2013. There will be no further annual adjustment.

SFY 2015 - Rates will be frozen at the rate in effect on June 30, 2014. There will be no further annual adjustments this state fiscal year.

Reference: Attachment 4.19-B, Section 13, Page 22

---

TN No: 13-018  
Supersedes  
TN No: 11-034

Approval Date: 12-11-13

Effective Date: 8/1/2013

State Plan Under Title XIX of the Social Security Act  
Medical Assistance Program  
State: North Carolina

Payments for Medical and Remedial Care and Services

---

Payment for High Risk Intervention – Level III – 4 Beds or Less:

SFY 2011 – The rates for SFY2011 are frozen as of the rates in effect at July 1, 2010. There will be no further annual adjustment.

SFY 2012 – Rates will be frozen at the rate in effect on June 30, 2011. Effective November 1, 2011, existing rates are adjusted by a negative 2.65% to yield a twelve (12) month two percent (2%) reduction in the nine (9) remaining months of this State Fiscal Year.

SFY 2013 – Effective July 1, 2012, the rates will be adjusted such that they will equal 98% of the rate in effect July 1, 2011. There will be no further annual adjustments this state fiscal year.

SFY 2014 – The rates will be frozen at the rates in effect on June 30, 2013. There will be no further annual adjustment.

SFY 2015 - Rates will be frozen at the rate in effect on June 30, 2014. There will be no further annual adjustments this state fiscal year.

Reference: Attachment 4.19-B, Section 13, Page 23

---

TN No: 13-018  
Supersedes  
TN No: 11-034

Approval Date: 12-11-13

Effective Date: 8/1/2013

State Plan Under Title XIX of the Social Security Act  
Medical Assistance Program  
State: North Carolina

Payments for Medical and Remedial Care and Services

---

Payment for High Risk Intervention – Level III – 5 Beds or More:

SFY 2011 – The rates for SFY2011 are frozen as of the rates in effect at July 1, 2010. There will be no further annual adjustment.

SFY 2012 – Rates will be frozen at the rate in effect on June 30, 2011. Effective November 1, 2011, existing rates are adjusted by a negative 2.65% to yield a twelve (12) month two percent (2%) reduction in the nine (9) remaining months of this State Fiscal Year.

SFY 2013 – Effective July 1, 2012, the rates will be adjusted such that they will equal 98% of the rate in effect July 1, 2011. There will be no further annual adjustments this state fiscal year.

SFY 2014 – The rates will be frozen at the rates in effect on June 30, 2013. There will be no further annual adjustment.

SFY 2015 - Rates will be frozen at the rate in effect on June 30, 2014. There will be no further annual adjustments this state fiscal year.

Reference: Attachment 4.19-B, Section 13, Page 24

---

TN No: 13-018  
Supersedes  
TN No: 11-034

Approval Date: 12-11-13

Effective Date: 8/1/2013

State Plan Under Title XIX of the Social Security Act  
Medical Assistance Program  
State: North Carolina

Payments for Medical and Remedial Care and Services

---

Payment for High Risk Intervention – Level IV:

SFY 2011 – The rates for SFY2011 are frozen as of the rates in effect at July 1, 2010. There will be no further annual adjustment.

SFY 2012 – Rates will be frozen at the rate in effect on June 30, 2011. Effective November 1, 2011, existing rates are adjusted by a negative 2.65% to yield a twelve (12) month two percent (2%) reduction in the nine (9) remaining months of this State Fiscal Year.

SFY 2013 – Effective July 1, 2012, the rates will be adjusted such that they will equal 98% of the rate in effect July 1, 2011. There will be no further annual adjustments this state fiscal year.

SFY 2014 – The rates will be frozen at the rates in effect on June 30, 2013. There will be no further annual adjustment.

SFY 2015 - Rates will be frozen at the rate in effect on June 30, 2014. There will be no further annual adjustments this state fiscal year.

Reference: Attachment 4.19-B, Section 13, Page 25

---

TN No: 13-018  
Supersedes  
TN No: 11-034

Approval Date: 12-11-13

Effective Date: 8/1/2013

State Plan Under Title XIX of the Social Security Act  
Medical Assistance Program  
State: North Carolina

Payments for Medical and Remedial Care and Services

---

Payment for Alcohol and/or drug services; group counseling by a clinician:

SFY 2011 – The rates for SFY2011 are frozen as of the rates in effect at July 1, 2010. There will be no further annual adjustment.

SFY 2012 – Rates will be frozen at the rate in effect on June 30, 2011. Effective November 1, 2011, existing rates are adjusted by a negative 2.65% to yield a twelve (12) month two percent (2%) reduction in the nine (9) remaining months of this State Fiscal Year.

SFY 2013 – Effective July 1, 2012, the rates will be adjusted such that they will equal 98% of the rate in effect July 1, 2011. There will be no further annual adjustments this state fiscal year.

SFY 2014 – The rates will be frozen at the rates in effect on June 30, 2013. There will be no further annual adjustment.

SFY 2015 - Rates will be frozen at the rate in effect on June 30, 2014. There will be no further annual adjustments this state fiscal year.

Reference: Attachment 4.19-B, Section 13, Page 26

---

TN No: 13-018  
Supersedes  
TN No: 11-034

Approval Date: 12-11-13

Effective Date: 8/1/2013

State Plan Under Title XIX of the Social Security Act  
Medical Assistance Program  
State: North Carolina

Payments for Medical and Remedial Care and Services

---

Payment for Behavioral health counseling and therapy:

SFY 2011 – The rates for SFY2011 are frozen as of the rates in effect at July 1, 2010. There will be no further annual adjustment.

SFY 2012 – Rates will be frozen at the rate in effect on June 30, 2011. Effective November 1, 2011, existing rates are adjusted by a negative 2.65% to yield a twelve (12) month two percent (2%) reduction in the nine (9) remaining months of this State Fiscal Year.

SFY 2013 – Effective July 1, 2012, the rates will be adjusted such that they will equal 98% of the rate in effect July 1, 2011. There will be no further annual adjustments this state fiscal year.

SFY 2014 – The rates will be frozen at the rates in effect on June 30, 2013. There will be no further annual adjustment.

SFY 2015 - Rates will be frozen at the rate in effect on June 30, 2014. There will be no further annual adjustments this state fiscal year.

Reference: Attachment 4.19-B, Section 13, Page 27

---

TN No: 13-018  
Supersedes  
TN No: 11-034

Approval Date: 12-11-13

Effective Date: 8/1/2013



State Plan Under Title XIX of the Social Security Act  
Medical Assistance Program  
State: North Carolina

Payments for Medical and Remedial Care and Services

---

Payment for Mental Health Assessment:

SFY 2011 – The rates for SFY2011 are frozen as of the rates in effect at July 1, 2010. There will be no further annual adjustment.

SFY 2012 – Rates will be frozen at the rate in effect on June 30, 2011. Effective November 1, 2011, existing rates are adjusted by a negative 2.65% to yield a twelve (12) month two percent (2%) reduction in the nine (9) remaining months of this State Fiscal Year.

SFY 2013 – Effective July 1, 2012, the rates will be adjusted such that they will equal 98% of the rate in effect July 1, 2011. There will be no further annual adjustments this state fiscal year.

SFY 2014 – The rates will be frozen at the rates in effect on June 30, 2013. There will be no further annual adjustment.

SFY 2015 - Rates will be frozen at the rate in effect on June 30, 2014. There will be no further annual adjustments this state fiscal year.

Reference: Attachment 4.19-B, Section 13, Page 28

---

TN No: 13-018  
Supersedes  
TN No: 11-034

Approval Date: 12-11-13

Effective Date: 8/1/2013

State Plan Under Title XIX of the Social Security Act  
Medical Assistance Program  
State: North Carolina

Payments for Medical and Remedial Care and Services

---

Payment for Mental Health Assessment:

SFY 2011 – The rates for SFY2011 are frozen as of the rates in effect at July 1, 2010. There will be no further annual adjustment.

SFY 2012 – Rates will be frozen at the rate in effect on June 30, 2011. Effective November 1, 2011, existing rates are adjusted by a negative 2.65% to yield a twelve (12) month two percent (2%) reduction in the nine (9) remaining months of this State Fiscal Year.

SFY 2013 – Effective July 1, 2012, the rates will be adjusted such that they will equal 98% of the rate in effect July 1, 2011. There will be no further annual adjustments this state fiscal year.

SFY 2014 – The rates will be frozen at the rates in effect on June 30, 2013. There will be no further annual adjustment.

SFY 2015 - Rates will be frozen at the rate in effect on June 30, 2014. There will be no further annual adjustments this state fiscal year.

Reference: Attachment 4.19-B, Section 13, Page 28

---

TN No: 13-018  
Supersedes  
TN No: 11-034

Approval Date: 12-11-13

Effective Date: 8/1/2013

MEDICAL ASSISTANCE  
STATE North Carolina

THERAPEUTIC LEAVE

- I. Therapeutic Leave for Nursing Facilities and Intermediate Care for the Mentally Retarded (ICF-MR):
- (a) Each Medicaid eligible patient who is occupying a Nursing Facility (NF) bed or an Intermediate Care for the Mentally Retarded (ICF-MR) bed for which the North Carolina Medicaid Program is then paying reimbursement shall be entitled to take up to 60 days of therapeutic leave in any calendar year from any such bed without the facility in which the bed is located suffering any loss of reimbursement during the period of leave.
  - (b) The taking of such leave must be for therapeutic purposes only, and must be ordered by the patient's attending physician. The necessity for such leave shall be documented in the patient's plan of care and therapeutic justification for each instance of such leave entered into the patient's medical record.
  - (c) Facilities must reserve a therapeutically absent patient's bed for him, and are prohibited from deriving any Medicaid revenue for that patient other than the reimbursement for that bed during the period of absence. Facilities shall be reimbursed at their full current Medicaid bed rate for a bed reserved due to therapeutic leave. Facilities shall not be reimbursed for therapeutic leave days taken which exceed the legal limit.
  - (d) No more than 15 consecutive therapeutic leave days may be taken without approval of the Division of Medical Assistance.
  - (e) The therapeutic justification for such absence shall be subject to review by the State or its agent during scheduled on-site medical reviews.
  - (f) Facilities must keep a cumulative record of therapeutic leave days taken by each patient for reference and audit purposes. In addition, patients on therapeutic leave must be noted as such on the facility's midnight census. Facilities shall bill Medicaid for approved therapeutic leave days as regular residence days.
  - (g) The official record of therapeutic leave days taken for each patient shall be maintained by the State or its agent.
  - (h) Entitlement to therapeutic leave is not applicable in cases when the therapeutic leave is for the purpose of receiving either inpatient or nursing services provided either elsewhere or at a different level of care in the facility of current residence when such services are or will be paid for by Medicaid.
  - (i) Transportation from a facility to the site of therapeutic leave is not considered to be an emergency; therefore, ambulance service for this purpose shall not be reimbursed by Medicaid.
  - (j) Effective July 1, 2005, entitlement to Therapeutic Leave is not applicable in the case of Medicaid Adult Care Home Personal Care Services (ACH-PCS).

TN. No. 05-009  
Supersedes  
TN. No. 03-003

Approval Date: October 25, 2005

Eff. Date 07/01/2005

MEDICAL ASSISTANCE  
STATE North Carolina

II. Therapeutic Leave for Psychiatric Residential Treatment Facilities (PRTF) and Levels II-IV Residential Facilities:

- (a) Each Medicaid eligible consumer who is occupying a Level II, Level III, or Level IV Residential Facility bed for which the North Carolina Medicaid Program is then paying reimbursement shall be entitled to take up to 45 days of therapeutic leave in any calendar year from any such bed without the facility in which the bed is located suffering any loss of reimbursement during the period of leave. Therapeutic leave is also limited to no more than 15 days within one calendar quarter (three months).
- (b) The taking of such leave must be for therapeutic purposes only, and must be agreed upon by the consumer's treatment team. The necessity for such leave and the expectations involved in such leave shall be documented in the consumer's treatment/habilitation plan and the therapeutic justification for each instance of such leave entered into the consumer's record maintained at the Residential Facility's site.
- (c) Therapeutic leave shall be defined as the absence of a consumer from the residential facility overnight, with the expectation of return, to participate in a medically acceptable therapeutic or rehabilitative facility as agreed upon by the treatment team and documented on the treatment/habilitation plan.
- (d) Facilities must reserve a therapeutically absent consumer's bed for him, and are prohibited from deriving any Medicaid revenue for that consumer other than the reimbursement for that bed during the period of absence. Facilities shall be reimbursed at their full current Medicaid bed rate for a bed reserved due to therapeutic leave. Facilities shall not be reimbursed for therapeutic leave days taken which exceed the legal limit.
- (e) No more than 5 consecutive days may be taken without the approval of the consumer's treatment team.
- (f) Facilities must keep a cumulative record of therapeutic leave days taken by each consumer for reference and audit purposes. In addition, consumers on therapeutic leave must be noted as such on the facility's midnight census. Facilities shall bill Medicaid for approved therapeutic leave days as regular residence days.
- (g) The official record of therapeutic leave days taken for each patient shall be maintained by the State or its agent.
- (h) Therapeutic leave is not applicable in cases when the therapeutic leave is for the purpose of receiving inpatient services or any other Medicaid-covered service in the facility of current residence or in another facility. Therapeutic leave cannot be paid when Medicaid is paying for any other 24 hour service.
- (i) Transportation from a facility to the site of therapeutic leave is not considered to be an emergency; therefore, ambulance service for this purpose shall not be reimbursed by Medicaid.

State Plan Under Title XIX of the Social Security Act  
Medical Assistance Program  
State: North Carolina

Payment for Services — Prospective Reimbursement Plan for Nursing Care Facilities

---

.0101 REIMBURSEMENT PRINCIPLES

All certified nursing facilities participating in the North Carolina Medicaid Program are reimbursed on a prospective basis as set forth hereunder, except that state-operated facilities will be reimbursed their reasonable and allowable costs in accordance with the Medicare principles of reimbursement and with the provisions of Section .0103 and .0104 of this plan. This plan is developed in accordance with the requirements of 42 CFR 447 Subpart C – Payment for Inpatient Hospital and Long-Term Care Facility Services. Providers must comply with all federal regulations and with the provisions of this plan.

TN. No. 08-007  
Supersedes  
TN. No. 92-21

Approval Date 01/15/09

Eff. Date 07/01/08

State Plan Under Title XIX of the Social Security Act  
Medical Assistance Program  
State: North Carolina

Payment for Services – Prospective Reimbursement Plan for Nursing Care Facilities

---

.0102 RATE SETTING METHODS

(a) A rate for nursing facility care is determined quarterly for each facility to be effective for dates of service for a three-month period beginning the first day of each calendar quarter. Rates are derived from audited cost reports for a base year period to be selected by the state. Audited cost reports for a base year is defined as desk audits performed on all Medicaid nursing facility cost reports filed for the base year plus a minimum of fifty (50) field audits on Medicaid nursing facility cost reports filed for the base year. The selection of field audits includes, but is not limited to, a risk based selection of providers with a direct cost per patient day above or below the Medicaid day weighted median direct cost per patient day. The selection of field audits also includes, but is not limited to, a risk based selection of providers with an indirect cost per patient day above or below the Medicaid day weighted median indirect cost per patient day. For rates effective January 1, 2008, the FY05 cost reports shall be used as the base year period. Cost reports are filed and audited under provisions set forth in Section .0104.

(b) Each prospective rate consists of two components – a direct care rate and an indirect rate – computed and applied as follows:

- (1) The direct care rate is that portion of the Medicaid daily rate that is attributable to:
  - (A) Case-mix adjusted costs defined as
    - (i) registered nurse (RN), licensed practical nurse (LPN) and nurse aide salaries and wages;
    - (ii) a direct allocation or proportionate allocation of allowable payroll taxes and employee benefits; and
    - (iii) the direct allowable cost of contracted services for RN, LPN and nurse aide staff from outside staffing companies.
  - (B) Non-case-mix adjusted costs defined as
    - (i) Nursing supplies;
    - (ii) Dietary or Food Service;
    - (iii) Patient Activities;
    - (iv) Social Services
    - (v) A direct allocation or proportionate allocation of allowable payroll taxes and employee benefits; and
    - (vi) Medicaid cost of Direct Ancillary services.

TN. No: 12-001  
Supersedes  
TN. No: 07-001

Approval Date: Dec 13, 2012

Eff. Date: 04/01/12

State Plan Under Title XIX of the Social Security Act  
Medical Assistance Program  
State: North Carolina

Payment for Services – Prospective Reimbursement Plan for Nursing Care Facilities

---

- (2) Each facility's direct care rate shall be determined as follows:
- (A) The per diem case-mix adjusted cost is determined by dividing the facility's case-mix adjusted base year cost by the facility's total base year inpatient days. This case-mix adjusted base year cost per diem shall be trended forward using the index factor set forth in Section .0102(e). A per diem neutralized case-mix adjusted cost is then calculated by dividing each facility's case-mix adjusted per diem cost by the facility cost report period case-mix index. The facility cost report period case-mix index is the resident-weighted average of quarterly facility-wide average case-mix indices, carried to four decimal places. The quarters used in this average will be the quarters that most closely coincide with the facility's base year cost reporting period. Example: An October 1, 2000 – September 2001 cost report period would use the facility-wide average case-mix indices for quarters ending December 31, 2000, March 31, 2001, June 30, 2001, and September 30, 2001.
  - (B) The per diem non-case-mix adjusted cost is determined by dividing the facility's non-case-mix adjusted base year cost, excluding the Medicaid cost of direct ancillary services, by the facility's total base year inpatient days plus the facility's Medicaid cost of direct ancillary services base year cost divided by the facility's total base year Medicaid resident days. This non-case-mix adjusted base year cost per diem shall be trended forward using the index factor set forth in Section .0102(e).

TN. No: 12-001  
Supersedes  
TN. No: NEW

Approval Date: Dec 13, 2012      Eff. Date: 04/01/12

State Plan Under Title XIX of the Social Security Act  
Medical Assistance Program  
State: North Carolina

Payment for Services – Prospective Reimbursement Plan for Nursing Care Facilities

---

- (C) The base year per diem neutralized case-mix adjusted cost and the base year per diem non-case-mix adjusted cost are summed for each nursing facility. Each facility's base year per diem result is arrayed from low to high and the Medicaid day weighted median cost is determined. Also for each facility, the percentage that each of these components represents of the total is determined.
- (D) The statewide direct care ceiling is established at 102.6 percent of the base year neutralized case-mix adjusted and non-case mix adjusted Medicaid day-weighted median cost.
- (E) For each nursing facility, the statewide direct care ceiling shall be apportioned between the per diem case-mix adjusted component and the per diem non-case-mix adjusted component using the facility-specific percentages determined in .0102(b)(2)(C).
- (F) On a quarterly basis, each facility's direct care rate shall be adjusted to account for changes in its Medicaid average case-mix index. The facility's direct care rate is determined as the lesser of (i) or (ii) as calculated below plus an incentive allowance.
  - (i) The facility's specific case-mix adjusted component of the statewide ceiling times the facility's Medicaid average case-mix index, plus each facility's specific non-case mix adjusted component of the statewide ceiling.
  - (ii) The facility's per diem neutralized case-mix adjusted cost times the Medicaid average case-mix index, plus the facility's per diem non case mix adjusted cost.Effective January 1, 2008, the incentive allowance is equal to 100% times the difference (if greater than zero) of (i) minus (ii) as calculated above. The Division of Medical Assistance may negotiate direct rates that exceed the facility's specific direct care ceiling for ventilator dependent and head injury patients. Payment of such special direct care rates shall be made only after specific prior approval of the Division of Medical Assistance.
- (G) For rates effective April 1, 2012, a Medicaid average case-mix index calculated for the snap shot dates September 30, 2011 and December 31, 2011, less any MDS review adjustments, shall be used to adjust the case-mix adjusted component of the statewide direct care ceiling. Effective July 1, 2012, the average case mix adjustment will return to a quarterly adjustment based on the prior quarter.

TN. No. 12-001  
Supersedes  
TN. No. 11-013

Approval Date: Dec 13, 2012

Eff. Date: 04/01/2012



Medical Assistance  
State North Carolina

Payment for Services – Prospective Reimbursement Plan for Nursing Care Facilities

- (H) The statewide direct care ceiling will be adjusted annually using the index factor set forth in Section .0102(e). The facility's base year per diem neutralized case-mix adjusted cost plus the facility's base year per diem non-case-mix adjusted cost will be adjusted annually using the index factor set forth in Section .0102(e).
- (3) The indirect rate is intended to cover the following costs of an efficiently and economically operated facility:
  - (A) Administrative and General,
  - (B) Laundry and Linen,
  - (C) Housekeeping,
  - (D) Operation of Plant and Maintenance/Non-Capital,
  - (E) Capital/Lease,
  - (F) Medicaid cost of Indirect Ancillary Services.
- (4) Effective for dates of service beginning October 1, 2003, the indirect rate will be standard for all nursing facilities. Each facility's per diem indirect cost is the sum of 1) the facility's indirect base year cost, excluding the Medicaid cost of indirect ancillary services, divided by the facility's total base year inpatient days plus 2) the facility's Medicaid cost of indirect ancillary services base year cost divided by the facility's total base year Medicaid resident days. The base year per diem indirect cost, excluding property ownership and use and mortgage interest shall be trended forward using the index factor set forth in Section .0102(e) of this section. Each facility's base year per diem indirect cost is arrayed from low to high and the Medicaid-day-weighted median cost is determined. The indirect rate is established at 100 percent of the Medicaid-day-weighted median cost. The indirect rate shall be adjusted annually by the index factor set forth in Section .0102(e).

(c) Nursing facility assessments. An adjustment to the nursing facility payment rate calculated in accordance with Section .0102(b) is established, effective October 1, 2003, to reimburse Medicaid participating nursing facilities for the provider's assessment costs that are incurred for the care of North Carolina Medicaid residents. No adjustment will be made for the provider's assessment costs that are incurred for the care of privately paying residents or others who are not Medicaid eligible.

(d) Fair Rental Value Payment for Capital. Effective for dates of service on or after January 1, 2007, the nursing facility capital related costs shall be reimbursed under a Fair Rental Value (FRV) methodology. The payment made under this methodology shall be the only payment for capital related costs, and no separate payment shall be made for depreciation or interest expense, lease costs, property taxes, insurance, or any other capital related cost. This payment is considered to cover costs related to land, land improvements, renovations, repairs, buildings and fixed equipment, major movable equipment, and any other capital related item. This shall be the case regardless of whether the property is owned or leased by the operator.

Medical Assistance  
State North Carolina

Payment for Services – Prospective Reimbursement Plan for Nursing Care Facilities

---

- (1) FRV Rate Year. Each provider shall receive a new capital per diem rate each year effective April 1st. The FRV payment rate shall be a facility specific per diem rate determined each year, using the data available from the Capital Data Surveys as of the previous September 30<sup>th</sup>. Capital Data Surveys will be submitted annually with each year's cost reports. The per diem shall be determined prospectively and shall apply for an entire fiscal year. FRV data elements that are not provider specific, including those published by RSMeans Construction cost data publication and the rental rate as determined by the Rolling 3-Year Average of the 10 Year US Treasury Bond interest rate, shall be determined annually on or about July 1<sup>st</sup> and shall apply to provider rates effective on the subsequent April 1<sup>st</sup>.
- (2) Calculation of FRV Per Diem Rate for Capital. Effective January 1, 2007, the new value construction cost per square foot shall be \$127.00. For FRV Per Diem rates effective April 1, 2008 and annually thereafter, the new value construction cost of \$127.00 per square foot shall be trended forward based on the historical cost index factor each July 1st as published annually in RSMeans Construction cost data publication (July 1, current year divided by July 1, previous year). The standard square footage of 450 square feet per bed, the \$5,000 addition per licensed bed for equipment, and the 15% land value to be added to the fixed capital replacement value was negotiated with the nursing home industry and validated against the two most recently awarded Certificate of Need (CON) applications, which were awarded on January 27, 2006 and July 28, 2006, by the Division of Health Service Regulation. A nursing facility's fair rental per diem is calculated as follows.
- (A) Multiply the number of licensed beds by the standard square footage of 450 square feet per bed; multiply this product by the January 1, 2007 new value construction cost per square foot of \$127.00 (trended value for rates effective April 1, 2008 and annually thereafter each April 1<sup>st</sup>); multiply this product by the appropriate location factor in 2007 RSMeans Construction cost data publication (2008 RSMeans Construction cost data publication to be used for rates effective April 1, 2008, and updated annually thereafter). Location factors are determined by the state and first three digits of the facility location zip code.

To this value add the product of the total licensed beds times \$5,000 for equipment. This result shall be depreciated at 2.00 percent per year according to the weighted average age of the facility. Bed additions, replacements and renovations may lower the weighted age of the facility. The maximum calculated age of a nursing facility shall be 32 ½ years; therefore, nursing facilities shall not be depreciated to an amount less than 35 percent or (100 percent minus (2.00 percent \* 32.5)) of the new bed value. There shall be no recapture of depreciation.

TN. No: 07-001  
Supersedes  
TN. No: NEW

Approval Date: March 19, 2008

Eff. Date: 01/01/07

State Plan Under Title XIX of the Social Security Act  
Medical Assistance Program  
State: North Carolina

Payment for Services – Prospective Reimbursement Plan for Nursing Care Facilities

- (B) The fixed capital replacement value is calculated by multiplying the new value construction cost per square foot of \$127.00 by the historical cost index factor by the location factor by the standard square footage. The land value is calculated by multiplying the fixed capital replacement value by 15 percent. The total replacement value is the sum of the land value plus the total depreciable capital assets.
- (C) A nursing facility's annual fair rental value (FRV) is calculated by multiplying the facility's total replacement value by a rental factor. The rental factor shall be determined by a rolling 3-Year average of the yield on the 10 Year US Treasury Bond (monthly frequency) as of July of the previous year plus a risk factor of 3.0 percent with an imposed floor of 7.5 percent and a ceiling of 9.5 percent. The risk factor of 3.0 percent with an imposed floor of 7.5 percent and a ceiling of 9.5 percent was negotiated with the nursing home industry. The Medicaid bed annual FRV is calculated by multiplying the annual fair rental value and the Medicaid utilization percentage.
- (D) Effective January 1, 2007, to calculate the Medicaid FRV per diem rate the nursing facility's Medicaid annual fair rental value shall be divided by the greater of the facility's annualized Total Patient Days as reported on the 2005 Medicaid cost report or 90 percent of the annualized licensed capacity of the facility to determine the FRV per diem (capital component of the rate). Subsequently effective April 1, 2008, the nursing facility's annual fair rental value shall be divided by the greater of the facility's annualized Total Patient Days as reported on the 2006 Medicaid cost report or 90 percent of the annualized licensed capacity of the facility to determine the FRV per diem. Each April 1st, the FRV calculation will utilize the most recent year of audited cost report patient days.

TN. No: 12-001  
Supersedes  
TN. No: 07-001

Approval Date: Dec 13, 2012

Eff. Date: 04/01/12

Medical Assistance  
State North Carolina

Payment for Services – Prospective Reimbursement Plan for Nursing Care Facilities

---

- (3) The initial age of each nursing facility used in the FRV calculation was determined from the 2004-2005 Capital Data Survey, using each facility's year of construction. This may be reduced for replacements, renovations and/or additions which are recorded on the Capital Data Survey to be filed annually with the Medicaid cost report. The age of the facility will be further adjusted each April 1 to make the facility one year older, up to the maximum age of 32 ½ years, and to reduce the age for those facilities that have completed and placed into service major renovation or bed additions. If a facility adds new beds, these new beds will be averaged in with the age of the original beds and the weighted average age for all beds will be used as the facility's age. If a facility performed a major renovation/replacement project (defined as a project with capitalized cost equal or greater than \$500 per licensed bed), the cost of the renovation project completed as of September 30th will be used to determine the weighted average age of all beds for this facility. To compute the weighted average of the beds, do a weighted average using the number of beds in the age group (value) as the weight. First, multiply each value by its weight. Second, add up the products of age multiplied by weight to get the total value. Third, add the weights together to get the total weight. Fourth, divide the total value by the total weights. The equivalent number of new beds from a renovation project will be determined by dividing the cost of the renovation/replacement project by the accumulated depreciation per bed of the facility's existing beds immediately before the renovation project.

(e) Index factor. The index factor shall be based on the Skilled Nursing Facility Market Basket without Capital Index published by Global Insight using the most current quarterly publication available annually as of August 1. The index factor shall not exceed that approved by the North Carolina General Assembly. If necessary, the Division of Medical Assistance shall adjust the annual index factor or rates in order to prevent payment rates from exceeding upper payment limits established by Federal Regulations.

(f) New Facilities and Transfer of Ownership of Existing Facilities

TN. No: 12-001  
Supersedes  
TN. No: 07-001

Approval Date: Dec 13, 2012

Eff. Date: 04/01/2012

Medical Assistance  
State North Carolina

Payment for Services – Prospective Reimbursement Plan for Nursing Care Facilities

---

- (1) New facilities are those entities whose beds have not previously been certified to participate or otherwise participated in the Medicaid program immediately prior to the operation of the new owner . A new facility's rate will be determined as follows and will continue to be reimbursed under this section until the incentive allowance percentage referenced in Section .0102(b)(2)(F) is equal to 100%:
  - (A) The direct care rate for new facilities will be equal to the statewide Medicaid day-weighted average direct care rate that is calculated effective on the 1<sup>st</sup> day of each calendar quarter. After the second full calendar quarter of operation, the statewide Medicaid day-weighted average direct care rate in effect for the facility shall be adjusted to reflect the facility's Medicaid acuity and the facility's direct care rate is calculated as the sum of the following:
    - (i) 65 percent of the statewide Medicaid day-weighted average direct care rate multiplied by the ratio of the facility's Medicaid average case-mix index (numerator) to the statewide Medicaid day-weighted average Medicaid case-mix index (denominator).
    - (ii) The statewide Medicaid day-weighted average direct care rate times 35%.
  - (B) The indirect rate for a new facility will be equal to the standard indirect rate in effect at the time the facility is enrolled in the Medicaid Program. The indirect rate shall be adjusted annually by the index factor set forth in Section .0102(e).
  - (C) A new facility's rate will include also the nursing assessment adjustment calculated in accordance with Section .0102(c).
- (2) Transfer of ownership of existing facilities. Transfer of ownership means, for reimbursement purposes, a change in the majority ownership that does not involve related parties or related entities including, but not limited to, corporations, partnerships and limited liability companies. Majority ownership is defined as an individual or entity that owns more than 50 percent of the entity, which is the subject of the transaction. The following applies to the transfer of ownership of a nursing facility:
  - (A) For any facility that transfers ownership, the new owner shall receive a per diem rate equal to the previous owner's per diem rate less any return on equity adjustment received by the previous owner, rate adjusted quarterly to account for changes in its Medicaid average case-mix index. The old provider's base year cost report shall become the new facility's base year cost report until the new owner has a cost report included in a base year rate setting.
  - (B) Regardless of changes in control or ownership for any facility certified for participation in the Medicaid program, the Division shall issue payments to the facility identified in the current Medicaid participation agreement. Regardless of changes in control of ownership for any facility certified for participation in Medicaid, the Division shall recover from that entity liabilities, sanctions and penalties pertaining to the Medicaid program, regardless of when the services were rendered.

State Plan Under Title XIX of the Social Security Act  
Medical Assistance Program  
State: North Carolina

Payment for Services – Prospective Reimbursement Plan for Nursing Care Facilities

(g) Each out-of-state provider is reimbursed at the lower of the appropriate North Carolina statewide Medicaid day-weighted average direct care rate plus the indirect rate or the provider's payment rate as established by the state in which the provider is located. For patients with special needs who must be placed in specialized out-of-state facilities, a payment rate that exceeds the North Carolina statewide Medicaid day-weighted average direct care rate plus the indirect rate may be negotiated. A facilities' negotiated rate for specialized services is based on budget projections of revenues, allowable costs, patient days, staffing and wages, at a level no greater than the facility's specific projected cost, and subject to review.

(h) Specialized Service Rates:

(1) Head Injury Intensive Rehabilitation Services –

- (A) A single all-inclusive prospective rate combining both the direct and indirect cost components can be negotiated for nursing facilities that specialize in providing intensive rehabilitation services for head injured patients as specified by criteria in Appendix 3 to Attachment 3.1-A of the State Plan. The rate may exceed the maximum rate applicable to other Nursing Facility services. A facility must specialize to the extent of staffing at least fifty percent (50%) of its nursing facility licensed beds for intensive head injury rehabilitation services. The facility must also be accredited by the Commission for the Accreditation of Rehabilitation Facilities (CARF).
- (B) A facility's initial rate is negotiated based on budget projections of revenues, allowable costs, patient days, staffing and wages, at a level no greater than the facility's specific projected cost, and subject to review upon the completion of an audited full year cost report. The negotiated rate shall not be less than the North Carolina statewide Medicaid day-weighted average direct care plus the indirect rate. A complete description of the facility's medical program must also be provided. Rates in subsequent years are determined by applying the index factor as set forth in Section .0102(e) to the rate in the previous year, unless either the provider or the State requests a renegotiation of the rate within sixty days (60) of the rate notice. Notwithstanding any other provision, if specified, these rates will be adjusted as shown on Attachment 4.19-D, Supplement 1, Page 1 of the State Plan.
- (C) Cost reports for this service shall be filed in accordance with Section .0104 but there shall not be cost settlements for any difference between cost and payments. The negotiated rate is considered to provide payment for all financial considerations and shall not include the fair rental value adjustment as defined in Section .0102 but shall include the nursing assessment adjustment as defined in Section .0102. The negotiated rate will be paid to the facility for services provided to head injured patients only. The per diem payment rate for non-head injured patients shall be the rate calculated in accordance with Section .0102 (b)–(e).

TN. No. 08-018  
Supersedes  
TN. No. 05-012

Approval Date: 03/12/09

Eff. Date: 12/01/2008

State Plan Under Title XIX of the Social Security Act  
Medical Assistance Program  
State: North Carolina

Payment for Services – Prospective Reimbursement Plan for Nursing Care Facilities

---

- (1) Ventilator Services:
  - (A) Ventilator services approved for nursing facilities providing intensive services or ventilator dependent patients are reimbursed at higher direct rates as described in Section .0102(b)(2).
  - (B) A facility's initial direct rate shall be negotiated based on budget projections of revenues, allowable costs, patient days, staffing and wages, at a level no greater than the facility's specific projected cost, and subject to review upon the completion of an audited full year cost report. The negotiated rate shall not be less than the North Carolina statewide Medicaid day-weighted average direct care plus the indirect rate. Rates in subsequent years are determined by applying the index factor as set forth in Section .0102(e) to the negotiated rate in the previous year, unless either the provider or the State requests a renegotiation of the rate within sixty days (60) of the rate notice.
  - (C) Cost reports for this service shall be filed in accordance with Section .0104 but there shall not be cost settlements for any difference between cost and payments.
  - (D) A single all-inclusive prospective per diem rate combining both the direct and indirect cost components can be negotiated for nursing facilities that specialize in providing intensive services for ventilator-dependent patients. The negotiated rate is considered to provide payment for all financial considerations and shall not include the fair rental value adjustment as defined in Section .0102. The negotiated rate will be paid to the facility for services provided to ventilator patients only. The per diem payment rate for non-ventilator patients shall be the rate calculated in accordance with Section .0102 (b) – (e). Notwithstanding any other provision, if specified, these rates will be adjusted as shown on Attachment 4.19-D, Supplement 1, Page 1 of the State Plan.

State Plan Under Title XIX of the Social Security Act  
Medical Assistance Program  
State: North Carolina

Payment for Services — Prospective Reimbursement Plan for Nursing Care Facilities

---

(1) Geropsychiatric Services:

(A) To determine the initial Medicaid rates for a Geropsychiatric unit, the projected costs for a start-up unit must be obtained (e.g., from the provider's operational budget, the State Certificate of Need Application, etc.). Only costs reflected for the geropsychiatry unit may be used in the projected rate calculation. To calculate the Projected Total Medicaid Reimbursement Rate, the total projected patient days, projected direct per diem costs, and projected indirect per diem costs must be calculated. Below is a description of the rate setting methodology:

(1) Total Available Bed Days: Multiply the projected inpatient days by the projected occupancy percentage to obtain total available bed days. Therefore, the calculation is as follows:

(Total Available Bed Days = Projected Inpatient Days \* Projected Occupancy %)

(2) Projected Direct Per Diem Costs: To calculate projected direct per diem costs, all direct expenditures from the direct cost centers of the geropsychiatry unit are summed and divided by the total available bed days. Therefore, the calculation is as follows:

(Projected Direct Per Diem Costs = Projected Direct Costs/Projected Total Available Bed Days)

(3) Projected Indirect Per Diem Costs: To calculate projected indirect per diem costs, all indirect expenditures of the geropsychiatry unit are summed and divided by the total available bed days. Therefore, the calculation is as follows:

(Projected Indirect Per Diem costs = Projected Indirect Costs/Projected Total Available Bed Days)



State Plan Under Title XIX of the Social Security Act  
Medical Assistance Program  
State: North Carolina

Payment for Services — Prospective Reimbursement Plan for Nursing Care Facilities

---

- (4) Projected Total Medicaid Reimbursement Rate: The projected direct rate and projected indirect rate are summed. Therefore, the calculation is as follows:

(Projected Total Medicaid Reimbursement Rate =  
Projected direct Per Diem costs + Projected Indirect Per  
Diem Costs)

- (B) A facility's initial direct rate shall be negotiated based on budget projections of revenues, allowable costs as defined by the CMS Provider Reimbursement Manual, patient days, staffing and wages, at a level no greater than the facility's specific projected cost, and subject to review upon the completion of an audited full year cost report. Upon issuance of the facility's final Adjustment Report, referenced in Section .0104(e), the State may change (i.e., increase or decrease) the facility's initial, negotiated direct rate to reflect the facility's actual direct rate cost but not to exceed the North Carolina state-wide Medicaid day-weighted average for direct care. This will become the facility's base direct rate and shall be adjusted in subsequent year in accordance with (E) of this section.

A facility's initial indirect rate shall be negotiated based on budget projections of revenues, allowable indirect costs as defined by the CMS Provider Reimbursement Manual, patient days, staffing and wages, at a level no greater than the facility's specific projected indirect cost, and subject to review upon the completion of an audited full year cost report. Upon issuance of the facility's final Adjustment Report, referenced in Section .0104(e), the State may change (i.e., increase or decrease) the facility's initial, negotiated indirect rate to reflect the facility's actual indirect rate cost but not to exceed the North Carolina state-wide Medicaid day-weighted average for base indirect cost. This will become the facility's base indirect cost.

TN No. 08-007  
Supersedes  
TN No. NEW

Approval Date 01/15/09

Effective Date: 07/01/08

State Plan Under Title XIX of the Social Security Act  
Medical Assistance Program  
State: North Carolina

Payment for Services — Prospective Reimbursement Plan for Nursing Care Facilities

---

- (C) Cost reports for this service shall be filed in accordance with Section .0104 but there shall not be cost settlements for any difference between cost and payments. The cost data provided by these cost reports shall be used to determine reasonable Medicaid cost for the delivery of this service. Providers of this service are required to annually file a cost report with the Division. Any Provider delinquent 30 days from the required filing date shall be subject to a 20% withhold of Medicaid payments. The payment withhold shall continue until a completed cost report is received by the Division. Once the Provider is compliant, all withheld payments shall be returned to the Provider.
- (D) A single all-inclusive prospective per diem rate combining both the direct and indirect cost components can be negotiated for nursing facilities that specialize in providing intensive services for geropsychiatric patients. The negotiated rate is based on the most recent filed annual cost report as required by Section .0104. It is considered to provide payment for all financial considerations and shall not include the fair rental value adjustment as defined in Section .0102. The negotiated rate will be paid to the facility for services provided to geropsychiatric patients only.
- (E) In subsequent years, Geropsychiatric unit rates are determined by applying the index factor to the current rate. The index factor shall be based on the Skilled Nursing Facility Market Basket without Capital Index published by Global Insight using the most current quarterly publication available annually as of August 1. The index factor shall not exceed that approved by the North Carolina General Assembly. If necessary, the Division of Medical Assistance shall adjust the annual index factor or rates in order to prevent payment rates from exceeding upper payment limits established by Federal Regulations.
- (F) Either the geropsychiatric provider or the Division of Medical Assistance may initiate a written request to appeal or renegotiate the rate within sixty (60) days of the date of the Division of Medical Assistance's rate notification.

TN No. 08-007  
Supersedes  
TN No. NEW

Approval Date 01/15/09

Effective Date: 07/01/08

Medical Assistance  
State North Carolina

Payment for Services – Prospective Reimbursement Plan for Nursing Care Facilities

---

(i) Religious Dietary Considerations.

- (1) A standard amount may be added to a nursing facility's rate for special dietary need for religious reasons.
- (2) Facilities must apply to receive this special payment consideration. In applying, facilities must document the reasons for special dietary consideration for religious reasons and must submit documentation for the increased dietary costs for religious reasons. Facilities must apply for this special benefit each time rates are determined from a new database. Fifty or more percent of the patients in total licensed beds must require religious dietary consideration in order for the facility to qualify for this special dietary rate add-on.
- (3) The special dietary add-on rate may not exceed more than 140% of the base year neutralized case-mix adjusted Medicaid-day-weighted median cost determined under Section .0102(b)(2) and adjusted for inflation each year until a new database is used to determine rates.

TN. No. 03-09  
Supersedes  
TN. No. 95-22

Approval Date 04/05/2004

Eff. Date 10/01/2003

Medical Assistance  
State North Carolina

Payment for Services – Prospective Reimbursement Plan for Nursing Care Facilities

---

.0103 REASONABLE AND NON-ALLOWABLE COSTS

(a) Providers have a responsibility to operate economically and efficiently so that their costs are reasonable. Providers are required to provide services at the lowest possible costs in compliance with Federal and State laws, regulations for licensing and certification, and standards for quality of care and patients' safety. Providers are also responsible for the financial actions of their agents (e.g., management companies) in this regard.

(b) The state may publish guidelines to define reasonable costs in certain areas after study of industry-wide cost conditions.

(c) The following costs are considered non-allowable facility costs because they are not related to patient care or are specifically disallowed under the North Carolina State Plan:

- (1) bad debts;
- (2) advertising – except personnel want ads, and one line yellow page (indicating facility address);
- (3) life insurance (except for employee group plans);
- (4) interest paid to a related party;
- (5) contributions, including political or church-related, charity and courtesy allowances;
- (6) prescription drugs and insulin (available to recipients under State Medicaid Drug Program);
- (7) vending machine expenses;
- (8) personal grooming other than haircuts, shampooing (basic hair care services) and nail trimming performed by either facility staff or barbers/beauticians. The facility may elect the means of service delivery. The costs of services beyond those provided by the nursing facility are the responsibility of the patient;
- (9) state or federal corporate income taxes, plus any penalties and interest;

TN. No. 03-09  
Supersedes  
TN. No. 92-21

Approval Date 04/05/2004

Eff. Date 10/01/2003

Medical Assistance  
State North Carolina

Payment for Services – Prospective Reimbursement Plan for Nursing Care Facilities

---

- (10) telephone, television, or radio for personal use of patient;
- (11) penalties or interest on income taxes;
- (12) dental expenses – except for consultant fees as required by law;
- (13) farm equipment and other expenses;
- (14) retainers, unless itemized services of equal value have been rendered;
- (15) physicians' fees for other than medical directors or medical consultants as required by law;
- (16) country club dues;
- (17) sitter services or private duty nurses;
- (18) fines or penalties;
- (19) guest meals;
- (20) morgue boxes;
- (21) leave days – except therapeutic leave;
- (22) personal clothing; and
- (23) ancillary costs that are billable to Medicare or other third party payors.

(d) For those non-allowable expenses which generate income, such as prescription drugs, vending machines, hair care (other than basic care), etc., expense should be identified as a non-reimbursable cost center where determinable. If the provider cannot determine the actual amount of expense which is to be identified, then the income which was generated must be offset in full to the appropriate cost center if the income reasonably covers the cost incurred. If income generated does not reasonably cover the cost incurred, an adjustment must be made to recognize a reasonable amount of non-reimbursable cost.

(e) For combination facilities (e.g. Nursing/Adult Care Home), providers must ensure that salary and wage expense coded or allocated to each area considers minimum staffing requirements (nursing hours per patient day or census statistics as appropriate).

Medical Assistance  
State North Carolina

Payment for Services – Prospective Reimbursement Plan for Nursing Care Facilities

.0104 COST REPORTING: AUDITING

(a) Each facility that receives payment from the North Carolina Medicaid Program must prepare and submit an annual report of its costs, including costs to meet the requirements of OBRA 87 (section 1919 of the Social Security Act) and other financial information to include, the facility's original working trial balance, year-end adjusting journal entries, and the facility's daily midnight census records for the cost reporting period. Pursuant to 42 CFR § 413, the report must include costs from the provider's fiscal period and must be submitted to the state; nursing facilities must submit cost reports within five (5) months after the provider's fiscal year end; hospital based nursing facility providers must submit cost reports pursuant to this plan, Attachment 4.19-A, Page 26, Paragraph (b). Facilities that fail to file their cost reports by the due date are subject to payment suspension as provided for under Section .0107(d)(4) until the reports are filed. The Division of Medical Assistance may extend the deadline 30 days for filing the report if, in its view, good cause exists for the delay. A good cause is an action that is uncontrollable by the provider. Cost report due date extensions must be requested by the facility and approved by the Division prior to the original filing deadline.

(b) Cost report format. For cost reports filed with the Division on or after January 1, 2012, for fiscal periods ending after September 30, 2011, nursing facilities shall use the CMS 2540 and hospital based nursing facility providers shall use the CMS 2552. These cost reports shall be completed in accordance with Medicare Reimbursement Principles and shall include supplemental schedules which are furnished by the Division to comply with the provisions of this plan. (c) Cost finding and allocation. Costs must be reported in the cost report and supplemental schedules in accordance with the following rules and in the order of priority stated.

- (1) Costs must be reported in accordance with the specific provisions of this plan as set forth in this Section.
- (2) Costs must be reported in conformance with the Medicare Provider Reimbursement Manual, CMS Publication 15.
- (3) Costs must be reported in conformance with Generally Accepted Accounting Principles.

TN. No. 12-001  
Supersedes  
TN. No. 03-09

Approval Date Dec 13, 2012

Eff. Date 4/1/2012

Medical Assistance  
State North Carolina

Payment for Services – Prospective Reimbursement Plan for Nursing Care Facilities

---

(d) The state will publish guidelines, consistent with the provisions of this plan, concerning the proper accounting treatment for items described in this Section. These guidelines may be modified prior to the beginning of each cost reporting period. In no case, however, shall any modifications be applied retroactively. A provider should request clarification in writing from the state if there is uncertainty about the proper cost center classification of any particular expense item.

- (1) Nursing Cost Center includes the cost of nursing staff, medical supplies, and related operating expenses needed to provide nursing care to patients, including medical records (including forms), the Medical Director and the Pharmacy Consultant. The amount of nursing time provided to each patient must be recorded in order to allocate nursing cost between reimbursable and non-reimbursable cost centers.
- (2) Dietary Cost center includes the cost of staff, raw food, and supplies needed to prepare and deliver food to patients.
- (3) Laundry and Linen Cost Center includes the cost of staff, bed linens (replacement mattresses and related operating expenses needed to launder facility-provided items).

TN. No. 03-09  
Supersedes  
TN. No. 96-05

Approval Date 04/05/2004

Eff. Date 10/01/2003

Medical Assistance  
State North Carolina

Payment for Services – Prospective Reimbursement Plan for Nursing Care Facilities

- (4) Housekeeping Cost Center includes the cost of staff and supplies needed to keep the facility clean.
- (5) Patient Activities Cost Center includes the cost of staff, supplies, and related operating expenses needed to provide supplies, and related operating expenses needed to provide appropriate diversionary activities for patients.
- (6) Social Services includes the cost of social workers and related operating expenses needed to provide necessary social services to patients.
- (7) Ancillary Cost Center includes the cost of all therapy services covered by the Medicaid program and billable medical supplies. Providers must bill Medicare Part B for those ancillary services covered under the Medicare Part B program. Ancillary cost centers include: Radiology, Laboratory, Physical Therapy, Occupational Therapy, Speech Therapy, Oxygen Therapy, Intravenous Fluids, Billable Medical Supplies, Parenteral/Enteral Therapy and life sustaining equipment, such as oxygen concentrators, respirators, and ventilators and other specifically approved equipment. Effective October 1, 1996, air fluidized beds (e.g. Clinitron beds), low air loss mattresses or beds and alternating pressure mattresses will be recorded in the life sustaining equipment cost center. This program is applicable to lease or depreciation expense incurred on or after October 1, 1996 regardless of when the equipment was initially leased or acquired.
  - (A) Effective October 1, 1994, a separate ancillary cost center shall be established to include costs associated with medically related transportation for facility residents. Medically related transportation costs include the costs of vehicles leased or owned by the facility, payroll costs associated with transporting residents and payments to third parties for providing these services.
- (8) Administrative and General Cost Center includes all costs needed to administer the facility including the staff costs for the administrator, assistants, billing and secretarial personnel, personnel director and pastoral expenses. It includes the costs of copy machines, dues and subscriptions, transportation, income taxes, legal and accounting fees, start-up, and a variety of other administrative costs as set forth in the Chart of Accounts. Interest expense other than that stemming from mortgages or loans to acquire physical plant items shall be reported here.
- (9) Capital/Lease:

TN. No. 03-09  
Supersedes  
TN. No. 96-05

Approval Date 04/05/2004

Eff. Date 10/01/2003



Medical Assistance  
State North Carolina

Payment for Services – Prospective Reimbursement Plan for Nursing Care Facilities

---

- (A) This cost center includes all allowable costs related to the acquisition and/or use of the physical assets including building, fixed equipment and movable equipment, that are required to deliver patient care, except for automobiles and the special equipment, as specified in .0104(d)(1) or .0104(d)(7) of this plan. Except for automobiles and the special equipment noted in section .0104(d)(1) and .0104(d)(7), it includes the following items:
- (i) lease expense for all physical assets,
  - (ii) depreciation of assets, utilizing the straight line method, per AHA guidelines
  - (iii) interest expense of asset related liabilities, (e.g., mortgage expense),

TN. No. 03-09  
Supersedes  
TN. No. 96-05

Approval Date 04/05/2004

Eff. Date 10/01/2003

Medical Assistance  
State North Carolina

Payment for Services – Prospective Reimbursement Plan for Nursing Care Facilities

---

- (B) In establishing the allowable cost for depreciation and for interest on capital indebtedness, with respect to an asset which has undergone a change of ownership, the valuation of the asset shall be the lesser of allowable acquisition cost less accumulated depreciation to the first owner of record on or after July 18, 1984 who has received Medicaid payments for said asset or the acquisition cost to the new owner. Payment of rent by the Medicaid enrolled provider to the lessor of the facility shall constitute Medicaid payments under this plan. Depreciation recapture will not be performed at sale. The method for establishing the allowable related capital indebtedness shall be as follows:
- (i) The allowable asset value shall be divided by the actual acquisition cost.
  - (ii) The product computed in step 1 shall be multiplied times the value of any related capital indebtedness.
  - (iii) The result shall be the liability amount upon which interest may be recorded at the rate set forth in the debt instrument or such lower rate as the state may prove is reasonable.

TN. No. 03-09  
Supersedes  
TN. No. 92-21

Approval Date 04/05/2004

Eff. Date 10/01/2003

Medical Assistance  
State North Carolina

Payment for Services – Prospective Reimbursement Plan for Nursing Care Facilities

---

- (10) Operation of Plant and Maintenance/Non-Capital Cost Center includes all cost necessary to operate or maintain the functionality and appearance of the plant. These include: buildings and equipment, automobile depreciation and lease expense, property taxes and property insurance.
- (11) Equipment expense. Equipment is defined as an item with a useful life of more than two years and a value greater than five thousand dollars (\$5000.00).
- (12) Training Expense. Training expense must be identified in the appropriate benefiting cost center.
- (13) The costs of training nurse aides in an approved competency and evaluation program must be identified separately on the cost report and may include the cost of purchasing programs and equipment that have been approved by the State for training or testing. These costs will be cost settled during the desk or field audit and are not included in the direct care and indirect cost centers.
- (14) Home Office Costs. Home office costs are generally charged to the Administrative and General Cost Centers. In some cases, certain personnel costs which are direct patient care oriented may be allocated to “direct” patient care cost centers if time records are maintained to document the performance of direct patient care services. No home office overhead may be so allocated. The basis of this allocation among facilities participating in the North Carolina Medicaid program may be: (A) specific time records of work performed at each facility, or (B) patient days in each facility to which the costs apply relative to the total patient days in all the facilities to which the costs apply.

TN. No. 03-09  
Supersedes  
TN. No. 96-05

Approval Date 04/05/2004

Eff. Date 10/01/2003

Medical Assistance  
State North Carolina

Payment for Services – Prospective Reimbursement Plan for Nursing Care Facilities

---

- (15) Management Fees. Management fees are charged to the Administrative and General Cost Center. However, a portion of a management fee may be allocated to a direct patient care cost center if time records are maintained to document the performance of direct patient care services. The amount so allocated may be equal only to the salary and fringe benefits of persons who are performing direct patient care services while employed by the management company. Adequate records to support these costs must be made available to staff of the Division of Medical Assistance. The basis of this allocation among facilities participating in the North Carolina Medicaid program may be: (A) specific time records of work performed at each facility, or (B) patient days in each facility to which the costs apply relative to the total patient days in all the facilities to which the costs apply.
- (16) Related Organization Costs. It is the nursing facility's responsibility to demonstrate by convincing evidence to the satisfaction of the Division of Medical Assistance that the costs are reasonable. Reasonable costs of related organizations are to be identified in accordance with direct and indirect cost center categories as follows:
- (A) Direct Cost:
- (i) Compensation of direct care staff such as nursing personnel (aides, orderlies, nurses), food service workers, and other personnel who are accounted for in the direct cost center.
  - (ii) Supplies and services that would normally be accounted for in a direct cost center.
  - (iii) Capital, rental, maintenance, supplies/repairs and utility costs (gas, water, fuel, electricity) for facilities that are not typically a part of a nursing facility. These facilities might include such items as warehouses, vehicles for delivery and offices which are totally dedicated or clearly exceed the number, size, or complexity required for a normal nursing facility, its home office, or management company.
  - (iv) Compensation of all administrative staff who perform no duties which are related to the nursing facility or its home office and who are neither officers nor owners of the nursing facilities or its home office.

TN. No. 03-09  
Supersedes  
TN. No. 92-21

Approval Date 04/05/2004

Eff. Date 10/01/2003

Medical Assistance  
State North Carolina

Payment for Services – Prospective Reimbursement Plan for Nursing Care Facilities

---

- (B) Indirect Cost:
- (i) Compensation of indirect staff such as housekeeping, laundry and linen, maintenance, and other personnel who would normally be accounted for in the indirect cost center.
  - (ii) Capital, rental, maintenance supplies/repairs, and utility costs which are normally or frequently a part of a nursing facility. This would include, for example, kitchen and laundry facilities.
  - (iii) Home office costs except for salary and fringe benefits of Personnel, Accounting and Data Processing staff which are allocated by approved methods are direct costs when the work performed is specific to the related organization that provides a direct care service or product to the provider.
  - (iv) Compensation of all administrative staff who perform any duties for the nursing facility or its home office.
  - (v) All compensation of all officers and owners of the nursing facility or its home office, or parent corporation.

The related organization must file a Medicaid Cost Statement (DMA-4083) identifying their costs, adjustments to costs, allocation of costs, equity capital, adjustments to equity capital, and allocations of equity capital along with the nursing facilities cost report. A home office, or parent company, will be recognized as a related organization. Auditable records to support these costs must be made available to staff of the Division of Medical Assistance and its designated contract auditors. Undocumented costs will be disallowed.

TN. No. 03-09  
Supersedes  
TN. No. 92-21

Approval Date 04/05/2004

Eff. Date 10/01/2003

Medical Assistance  
State North Carolina

Payment for Services – Prospective Reimbursement Plan for Nursing Care Facilities

It is the nursing facility's responsibility to demonstrate by convincing evidence to the satisfaction of the Division of Medical Assistance that the criteria in the Provider Reimbursement Manual, Section 1010, has been met in order to be recognized as an exception to the related organization principle.

When a related organization is deemed an exception; (1) reasonable charges by the related organization to the nursing facility are recognized as allowable costs; (2) receivables/payables from/to the nursing facility and related organization deemed an exception are not adjusted from the nursing facility's balance sheet in computing equity capital.

(e) Auditing. All filed cost reports shall be desk audited in accordance with the provision of this plan. An Audit Adjustment Report shall be issued within one year of the date the cost report was filed or within one year of December 31 of the fiscal year to which the report applies, whichever is later. The state may elect to perform field audits on any filed cost reports within three years of the date of filing and issue a final Audit Adjustment Report on a time schedule that conforms to Federal law and regulation. If the state does not field audit a facility a final Audit Adjustment Report shall be issued based on the desk audited findings. The state may reopen and field audit any cost report after the final Audit Adjustment Report to comply with Federal law and regulation or to enforce laws and regulations prohibiting abuse of the Medicaid Program and particularly the provisions of this reimbursement plan.

(f) Penalties. Providers who fail to fully and accurately complete cost reports or who fail to furnish required documentation and disclosures for cost reports required under this Plan may be subject to penalties for non-compliance. Issues which are subject to penalties include, but are not limited to, material miscoding of cost from Indirect to Direct cost centers or from Non-Reimbursable to Reimbursable cost centers, inaccurate identification of census data or ancillary charges by payor type, and failure to disclose related parties including those deemed non-related by exception. Errors in a filed cost report which result in an adjustment greater than one percent (1%) of a provider's reimbursable total cost per the filed cost report reported in the cost report shall be subject to penalty. Penalty will be defined as the dollar value equal to five percent of the Medicaid percentage, as defined by occupancy, of the adjustment.

TN. No. 03-09  
Supersedes  
TN. No. 92-21

Approval Date 04/05/2004

Eff. Date 10/01/2003

Medical Assistance  
State North Carolina

Payment for Services – Prospective Reimbursement Plan for Nursing Care Facilities

.0105 CASE-MIX INDEX CALCULATION

(a) The Resource Utilization Groups-III (RUG-III) Version 5.12b, 34 group, index maximizer model shall be used as the resident classification system to determine all case-mix indices, using data from the minimum data set (MDS) submitted by each facility to the Division of Facility Services. The following case-mix indices shall be the basis for calculating facility average case-mix indices to be used in determining the facility's direct care rate.

<u>RUG Code</u>	<u>Case-Mix Index</u>	<u>RUG Code</u>	<u>Case-Mix Index</u>	<u>RUG Code</u>	<u>Case-Mix Index</u>
SE3	2.08	CB2	1.13	PE2	0.97
SE2	1.70	CB1	1.01	PE1	0.96
SE1	1.45	CA2	1.02	PD2	0.91
RAD	1.68	CA1	0.92	PD1	0.83
RAC	1.41	IB2	0.89	PC2	.82
RAB	1.28	IB1	0.82	PC1	.80
RAA	1.06	IA2	0.74	PB2	.66
SSC	1.40	IA1	0.64	PB1	.61
SSB	1.29	BB2	0.86	PA2	.60
SSA	1.25	BB1	0.80	PA1	.57
CC2	1.39	BA2	0.72		
CC1	1.23	BA1	0.61		

(b) Each resident in the facility on the last day of each quarter with a completed and submitted assessment shall be assigned a RUG-III 34 group calculated on the resident's most current assessment available with an assessment reference date on or prior to the last day of each calendar quarter. This RUG-III group shall be translated to the appropriate case-mix index referenced in paragraph "a". If the most current assessment available with an assessment reference date on or prior to the last day of the calendar quarter is a delinquent MDS then the RUG-III code assigned shall be a BC1-delinquent and the lowest case-mix index in paragraph "a" will be applied. A delinquent MDS is defined as 121 days from the R2b date of the MDS assessment (completion date). From the individual resident case-mix index, two average case-mix indices for each Medicaid nursing facility shall be determined four times per year based on the last day of each calendar quarter.

(c) The facility-wide average case-mix index is the simple average, carried to four decimal places, of all resident case-mix indices. The Medicaid average case-mix index is the simple average, carried to four decimal places, of all indices for residents where Medicaid or Medicaid pending is known to be the per diem payor source on the last day of the calendar quarter.

TN. No. 03-09  
Supersedes  
TN. No. 93-23

Approval Date 04/05/2004

Eff. Date 10/01/2003

Payment for Services – Prospective Reimbursement Plan for Nursing Care Facilities

---

---

.0106 RECONSIDERATION REVIEWS

- (a) Providers may either accept agency reimbursement determinations or request a reconsideration review in accordance with the procedures set forth in 10A NCAC 22I and 22J.
- (b) Indirect rates shall not be adjusted on reconsideration review.
- (c) Direct rates may be adjusted for the following reasons:
  - (1) to accommodate any changes in the minimum standards or minimum levels of resources required in the provision of patient care that are mandated by state or federal laws or regulation;
  - (2) to correct any adjustments or revisions to ensure that the payment rate is calculated in accordance with Section .0102.



Medical Assistance  
State North Carolina

Payment for Services – Prospective Reimbursement Plan for Nursing Care Facilities

---

.0107 PAYMENT ASSURANCE

(a) The state will pay each provider of nursing care services, who furnishes the services in accordance with the requirements of the State Plan and the Participation agreement, the amount determined under the plan. In addition, Nursing Facilities must be enrolled in the Title XVIII Program. However, State-operated nursing facilities are not required to be enrolled in the Medicare program.

(b) The payment methods and standards set forth herein are designed to enlist the participation of any provider who operates a facility both economically and efficiently. Participation in the program shall be limited to providers of service who accept, as payment in full, the amounts paid in accordance with the State Plan. This reimbursement plan is effective upon approval of the State Plan for Medical Assistance.

TN. No. 03-09  
Supersedes  
TN. No. 92-21

Approval Date 04/05/2004

Eff. Date 10/01/2003

Medical Assistance  
State North Carolina

Payment for Services – Prospective Reimbursement Plan for Nursing Care Facilities

---

(c) In all circumstances involving third party payment, Medicaid is the payor of last resort. No payment will be made for a Medicaid recipient who is also eligible for Medicare, Part A, for the first 20 days of care rendered to skilled nursing patients. Medicaid payments for coinsurance for such patients will be made for the subsequent 21<sup>st</sup> through the 100<sup>th</sup> day of care. The Division of Medical Assistance will pay an amount for each day of Medicare Part A inpatient coinsurance, the total of which will equal the facility's Medicaid per diem rate less any Medicare Part A payment, but no more than the Medicare coinsurance amount. In the case of ancillary services, providers are obligated to:

- (1) maintain detailed records or charges for all patients;
- (2) bill the appropriate Medicare Part B carrier for all services provided to Medicaid patients that may be covered under that program; and
- (3) allocate and appropriate amount of ancillary costs, based on these charge records adjusted to reflect Medicare denials of coverage, to Medicare Part B in the annual cost report. For failure to comply with this requirement, the state may charge a penalty of up to 5 percent of a provider's indirect patient care rate for each day of care that is provided during the fiscal year in which the failure occurs. This penalty shall not be considered an allowable cost for cost reporting purposes.
- (4) Properly bill Medicare or other third-party payors or have disallowance of any related cost claimed as Medicaid cost.

(d) The state may withhold payments to providers under the following circumstances:

TN. No. 03-09  
Supersedes  
TN. No. 92-21

Approval Date 04/05/2004

Eff. Date 10/01/2003

Medical Assistance  
State North Carolina

Payment for Services – Prospective Reimbursement Plan for Nursing Care Facilities

---

- (1) Upon determination of any sum due the Medicaid Program or upon instruction from a legally authorized agent of State or Federal Government, the state may withhold sums to meet the obligations identified.
- (2) The state may arrange repayment schedules within the limits set forth in federal regulations in lieu of withholding funds.
- (3) The state may charge reasonable interest on over-payments from the date that the overpayment occurred.
- (4) The State may withhold up to twenty (20) percent per month of a provider's payment for failure to file a timely cost report and associated accounting records. The funds will be released to the provider after a cost report is acceptably filed. The provider will experience delayed payment while the check is routed to the State and split for the amount withheld.

**.0108 REIMBURSEMENT METHODS FOR STATE-OPERATED FACILITIES**

- (a) A certified State-operated nursing facility is reimbursed for the reasonable costs that are necessary to efficiently meet the needs of its patients and to comply with federal and state laws and regulations. The costs are determined in accordance with Sections .0103 and .0104 except that annual cost reports are required for the fiscal year beginning on July 1 and ending on the following June 30 and must be submitted to the Division of Medical Assistance within 150 days after their fiscal year end. Payments will be suspended if reports are not filed. The Division of Medical Assistance may extend the deadline for filing the report, if in its view; good cause exists for the delay. The Medicare principles for the reimbursement of skilled nursing facilities will be utilized for the cost principles that are not specifically addressed in the State Plan.
- (b) A per diem rate based on the provider's estimated annual cost divided by patient days will be used to make interim payments. A desk audit will be performed on each annual cost report to determine the amount of Medicaid reasonable cost and the amount of interim payments received by the provider.

**.0109 REIMBURSEMENT METHODS FOR TRIBAL OPERATED FACILITIES**

- (a) A nursing facility owned and operated by an Indian Tribe, Tribal Organization, or Urban Indian Organization as defined in section 1139(c) of the Social Security Act shall be reimbursed for the reasonable costs that are necessary to efficiently meet the needs of its patients and to comply with federal and state laws and regulations. The costs are determined in accordance with sections .0103 and .0104 except that annual cost reports are required for the fiscal year beginning on October 1 and ending on the following September 30 and must be submitted to the Division of Medical Assistance within 90 days after their fiscal year end. Payments will be suspended if reports are not filed. The Division of Medical Assistance may extend the deadline for filing the report, if in its view; good cause exists for the delay. The Medicare principles for the reimbursement of skilled nursing facilities will be utilized for the cost principles that are not specifically addressed in the State Plan.
- (b) A facility per diem rate shall be calculated annually by dividing the allowed Medicaid cost by the Medicaid days. The provider's last audited cost report shall be the basis for the calculation. The rate shall be effective each October 1, and shall not be subject to cost settlement.

TN. No. 12-001  
Supersedes  
TN. No. 03-09

Approval Date Dec 13, 2012

Eff. Date 04/01/2012

Medical Assistance  
State North Carolina

Payment for Services – Prospective Reimbursement Plan for Nursing Care Facilities

The State has in place a public process which complies with the requirements of Section 1902(a)(13)(A) of the Social Security Act.

TN. No. 03-09  
Supersedes  
TN. No. 97-11

Approval Date 04/05/2004

Eff. Date 10/01/2003

State Plan Under Title XIX of the Social Security Act  
Medical Assistance Program  
State: North Carolina

Payment for Services – Prospective Reimbursement Plan for Nursing Care Facilities

---

Payment for Head Injury and Ventilator Nursing Beds:

FY 2005 and 2006 – No rate increase from the June 30, 2005 rate for all Medicaid private and public providers with the following exceptions: federally qualified health clinics, rural health centers, state institutions, outpatient hospital, pharmacy and the non-inflationary components of the case-mix reimbursement system for nursing facilities.

NC General Assembly legislation mandates that effective July 1, 2005, reimbursement rates for these programs (Head Injury and Ventilator Nursing Beds) for the state fiscal years 2005-2006 and 2006-2007 will remain at the rate in effect as of June 30, 2005, except rates may be adjusted downward.

FY 2008-2009 – No Adjustment for Head and Vent Beds

FY 2009-2010 – The rates for SFY2010 are frozen as of the rates in effect July 1, 2009. Effective October 1, 2009, an overall rate reduction adjustment of 4.70% (annualized over 9 months) for Head Injury and Ventilator beds.

FY 2010-2011 – As of July 1, 2010, rates will be frozen as in effect June 30, 2010.

SFY 2012 – Rates will be frozen at the rate in effect on June 30, 2011. Effective October 1, 2011, existing rates are adjusted by a negative 2.67% to yield a twelve (12) month two percent (2%) budget reduction in the nine (9) remaining months of this State Fiscal Year.

SFY 2013 – Effective July 1, 2012, the rates will be adjusted such that they will equal 98% of the rate in effect July 1, 2011. There will be no further annual adjustments this state fiscal year.

SFY 2014 – Effective August 1, 2013, rates will be frozen at the rates in effect June 30, 2013. There will be no further annual adjustment.

SFY 2015 – Effective July 1, 2014, rates will be frozen at the rates in effect June 30, 2014. There will be no further annual adjustments this state fiscal year.

Reference: Attachment 4.19-D, Page 6 and 7

---

TN. No. 13-032

Supersedes

TN. No. 11-027

Approval Date: 12/20/13

Eff. Date: 08/01/13

State Plan Under Title XIX of the Social Security Act  
Medical Assistance Program  
State: North Carolina

Payment for Services – Prospective Reimbursement Plan for Nursing Care Facilities

---

Payment for Geropsychiatric Services:

FY 2009-2010 – The rates for SFY2010 are frozen as of the rates in effect July 1, 2009. Effective October 1, 2009 an overall rate reduction adjustment of 4.54% rate reduction (annualized over 9 months) for Geropsychiatric Services.

FY 2010-2011 – As of July 1, 2010, rates will be frozen

SFY 2012 – Rates will be frozen at the rate in effect on June 30, 2011. Effective October 1, 2011, existing rates are adjusted by a negative 2.67% to yield a twelve (12) month two percent (2%) budget reduction in the nine (9) remaining months of this State Fiscal Year.

SFY 2013 – Effective July 1, 2012, the rates will be adjusted such that they will equal 98% of the rate in effect July 1, 2011. There will be no further annual adjustments this state fiscal year.

SFY 2014 – Effective August 1, 2013, rates will be frozen at the rates in effect June 30, 2013. There will be no further annual adjustment.

SFY 2015 – Effective July 1, 2014, rates will be frozen at the rate in effect June 30, 2014. There will be no further annual adjustments this state fiscal year.

Reference: Attachment 4.19-D, Page 7a, 7b, and 7c

---

TN. No. 13-032  
Supersedes  
TN. No. 11-027

Approval Date: 12/20/13

Eff. Date: 08/01/2013

State Plan Under Title XIX of the Social Security Act  
Medical Assistance Program  
State: North Carolina

Payment for Services – Prospective Reimbursement Plan for Nursing Care Facilities

---

Payment for Nursing Facility Beds:

FY 2005 and 2006 – No rate increase from the June 30, 2005 rate for all Medicaid private and public providers with the following exceptions: federally qualified health clinics, rural health centers, state institutions, outpatient hospital, pharmacy and the non-inflationary components of the case-mix reimbursement system for nursing facilities.

FY 2007 – An appropriated 1.482% recurring inflationary increase for the Nursing Home program will be effective January 1, 2007.

FY 2009-2010 – The rates for SFY2010 are frozen as of the rates in effect July 1, 2009. Effective October 1, 2009 an overall rate reduction adjustment of 1.30% rate reduction (annualized over 8 months) for Nursing Care facilities.

FY 2010-2011 – Effective January 1, 2011, rates will be adjusted for an increase of 2.15% for Nursing Care facilities.

FY 2011-2012 – Effective July 1, 2011, rates will be adjusted for a decrease of 3.06% for Nursing Care facilities.

FY 2012 – Effective April 1, 2012, the direct and indirect components of reimbursement rates will be adjusted for an increase of 3.129% for Nursing Care facilities.

FY 2012-2013 – As of July 1, 2012, rates will be adjusted to reflect a flat, 2.17% reduction on the direct and indirect components of the Nursing Facility rates in effect on June 30, 2011. Rates will be reviewed annually prior to each September 1st of the succeeding calendar year.

SFY 2014 – Effective January 1, 2014, rates in effect as of December 31, 2013 will be reduced by 3% and there after shall only be adjusted by the quarterly case mix adjustment applied to the direct care component of the per diem rate.

SFY 2015 – Effective July 1, 2014, rates will be frozen at the rates in effect June 30, 2014. Effective January 1, 2015, the case mix for direct care services will be frozen, and the rates will not increase above the rate in effect on December 31, 2014. Effective June 1, 2015, the rates in effect as of May 31, 2015 will be increased by 3%.

Reference: Attachment 4.19-D, Page 1 thru 5

---

TN. No. 14-040  
Supersedes  
TN. No. 14-010

Approval Date: 05-22-15

Eff. Date: 01/01/2015

State Plan Under Title XIX of the Social Security Act  
Medical Assistance Program  
State: North Carolina

Payment for Services – Prospective Reimbursement Plan for Nursing Care Facilities

---

Payment for Nursing Facility Beds – Continued:

SFY 2016 – Effective July 1, 2015, rates will be frozen at the rates in effect on June 30, 2015. There will be no further adjustments this state fiscal year.

Reference: Attachment 4.19-D, Page 1 thru 5

---

TN. No. 14-040  
Supersedes  
TN. No. NEW

Approval Date: 05-22-15

Eff. Date: 01/01/2015



MEDICAL ASSISTANCE  
State: North Carolina

**PROSPECTIVE REIMBURSEMENT PLAN FOR ICF-MR FACILITIES  
PAYMENT FOR SERVICES**

---

---

.0301 Payment for Services-Prospective Reimbursement Plan for ICF-MR Facilities

All certified intermediate care facilities - mentally retarded (ICF-MR) participating in the North Carolina Medicaid Program are reimbursed on a prospective basis as set forth hereunder, except that state-operated facilities shall be reimbursed their reasonable and allowable costs in accordance with the Medicare principles of reimbursement and with the applicable provisions of this plan. This plan is developed in accordance with the requirement of 42 CFR 447 Subpart C-Payment for Inpatient Hospital and Long-Term Care Facility Services. Providers shall comply with all federal regulations and with the provisions of this plan.

TN No. 95-03  
Supersedes  
TN No. 93-12

Approval Date Jul 17 1997

Eff. Date: 7/1/95

REPORTING REQUIREMENTS

---

.0302 REPORTING REQUIREMENTS

- (a) Financial reports shall include the following:
- (1) Budget reports: Each provider shall include appropriate budget information in its application for an initial rate for a new facility:
    - (A) The budget shall reflect the projected annual operating results of each of two years subsequent to the commencement of operating said facility.
    - (B) The budget information used to support the Certificate of Need award shall be provided to the Division of Medical Assistance on or before 30 days prior to the enrollments of said facility by the Medicaid program.
    - (C) Budgets are not deemed to be appropriately filed unless they are properly prepared, in accordance with rules established by the Division of Medical Assistance.
  - (2) Cost reports: Each facility that receives payments from the North Carolina Medicaid Program shall prepare and submit a separate annual cost report of its costs, a working trail balance related to reimbursement, and other financial information as requested by the Division of Medical Assistance. Providers that have an approved combined uniform rate in accordance with Section .0304 Paragraph (n) of this reimbursement plan shall file a combined cost report that is supported by the individual facility cost reports. For these providers, the combined cost report shall be filed with the Division of Medical Assistance Audit Section while the individual facility cost reports shall be filed with the Division of Medical Assistance Rate Setting Section.
    - (A) The cost report shall cover a 12 month period, from July 1 to the following June 30, unless another time frame is specified by the Division of Medical Assistance.
      - (i) A short year cost report shall be filed for facilities certified in the Medicaid program during the year, with the cost report period commencing on the date of certification and ending the following June 30.
      - (ii) A short year cost report shall be filed for facilities terminated from the Medicaid program during the year, with the cost report period commencing on July 1 and ending on the date of termination.
    - (B) The cost report shall be submitted to the state on or before the September 30 that immediately follows the June 30 year end. The Division of Medical Assistance may grant an extension of time of up to 30 days for filing the cost report, upon showing of just cause in writing by the provider. For purposes of this Section, "just cause" is an action that is uncontrollable by the provider, such as tornado, hurricane, strong wind damage, etc.
    - (C) For new facilities a cost report shall be submitted for the period beginning with the date of certification and ending on the following June 30.
    - (D) The cost report shall be based on the Chart of Accounts specified by the Division of Medical Assistance. The Chart of Accounts includes a description of each account to be used on the cost report. The Chart of Accounts shall be distributed

---

---

to each provider by the Division of Medical Assistance. This material is available for inspection and copies may be obtained from the Division at 1985 Umstead Drive, Raleigh, North Carolina 27603 at a cost of twenty cents (\$.20) per page. All costs shall be shown on the cost reports in accordance with rules established by the Division of Medical Assistance. A cost report that does not meet the requirements of the Division of Medical Assistance is deemed not to be filed.

- (E) Currently filed cost reports shall reflect the decisions and judgments expressed by the Division of Medical Assistance auditors on previous cost reports.
- (F) All related organizations shall file a Medicaid cost statement identifying their costs, adjustments to costs, and allocations of costs along with the ICF-MR facility's cost report. A home office, or parent company, shall be recognized as a related organization. Auditable records to support these costs shall be made available to the Division of Medical Assistance and its designated contract auditors. Undocumented costs shall be disallowed for Medicaid reimbursement.
- (G) Cost reports shall clearly identify related party transactions. Failure to do so may result in the related cost being disallowed for Medicaid reimbursement purposes.
- (H) A combined cost report may only be filed for facilities that use the same cost settlement methodology and have a uniform rate, as approved by the Division of Medical Assistance.

(b) Additional information reporting requirements for facilities shall include , but not be limited to, the following:

- (1) Each facility providing day treatment services shall be required to submit, in conjunction with the cost report, a separate report itemizing the actual expense attributable to the provision of day treatment services and the actual number of client days associated with said expense.
- (2) Each provider operating a facility, upon the request of the Division of Medical Assistance, shall submit statistical data and other information relevant to the administration and operation of said facility. Such reports shall be submitted within the time frames authorized in the request.
- (3) Each provider that issues an annual report to its shareholders shall file a copy of said report with the Division of Medical Assistance. Said report shall be filed within 30 days of its issuance to the shareholders.
- (4) Each provider that has a compensatory stock option plan shall file a copy of said plan with the Division of Medical Assistance, within 30 days of its implementation.
- (5) A provider shall file an information report with the Division of Medical Assistance within 30 days of receiving notification from either the North Carolina Department of Revenue or the Internal Revenue Service that items, previously reported and allowed on a cost report, have been disallowed on the provider's associated tax return.

- (c) Requirements for certification of financial reports.
- (1) Each provider that operates a facility shall complete the required financial reports in accordance with the following rules and in the order of priority stated:
    - (A) Cost shall be represented in accordance with the specific provisions as set forth in this Plan.
    - (B) Costs shall be reported in conformance with the Medicare Provider Reimbursement Manual, HCFA-15, which is hereby incorporated by reference including subsequent amendments and editions. Said manual is commonly referred to as the HCFA-15 manual and is available for inspection at the Division of Medical Assistance, 1985 Umstead Drive, Raleigh, NC 27603. Copies may be obtained from the Superintendent of Documents, U.S. Government Printing Office, Washington, DC 20402-9325 at a cost of three hundred fifty seven dollars (\$357.00). Tel: (202) 783-3238.
    - (C) Costs shall be reported in conformance with generally accepted accounting principles.
    - (D) Governmental institutions have the option of using the accrual or cash method of accounting.
  - (2) Cost reports prepared for facilities shall be certified for their compliance with Subparagraph (c)(1) of this Section by the provider's executive director or designated officer.
  - (3) Budget reports prepared for facilities shall be certified for their fair representation of anticipated disbursements and receipts related to the Medicaid ICF-MR program by the provider's executive director or designated officer.
- (d) Requirements for the revision of financial reports shall include the following:
- (1) In the event the Division of Medical Assistance determines a cost report does not meet the requirement of the Division of Medical Assistance during a detailed review, the provider shall have 30 days from the date of said notification to submit a revised cost report or additional data. Such revised data or report shall be certified by the provider's executive director or designated officer.
  - (2) In the event that the provider discovers that a report submitted to the Division of Medical Assistance is incomplete, inaccurate, or incorrect, the provider shall immediately notify the Division of Medical Assistance that such error(s) exist. The provider shall have 30 days from the date of said notification to submit a revised report or additional data. Such data or report shall meet the certification requirements of the report being corrected.
  - (3) Failure to file the corrected reports on a timely basis in accordance to either Subparagraph (d)(1) or (2) of this Section shall result in the related report being considered not filed and subject to the provisions under this State Plan related to the failure to file said reports. However, the Division of Medical Assistance may grant an extension of time of up to 30 days to file said corrected reports, upon the showing of just cause by the provider in writing.

## REQUIREMENTS FOR FINANCIAL RECORDS

---

.0303      REQUIREMENTS FOR FINANCIAL RECORDS

Each provider shall maintain facility-specific financial records which reflect all expenditures incurred and revenues earned related to its ICF-MR services in the Medicaid Program. In addition, the financial records shall properly and clearly reflect all other sources of funds available to the facility's Medicaid ICF-MR program.

- (1) Such financial records shall provide clear and precise justification and support for entries included in the cost report, and included in related budgets.
- (2) The financial records shall include at a minimum separate accounts for each type of expense, revenue, and other funding resources included in the annual cost report.
  - (A) All items on the cost report shall be supported by clear and precise financial records. Cost reports that fail this requirement are deemed to be improperly filed and subject to the provisions under this plan related to the failure to file said reports.
- (3) Effective July 1, 1993, property ownership and use, housekeeping, and operation and maintenance of plant costs related to day treatment services should be separately accounted for on the provider's books and records. Said costs should be reported separately as direct care costs on the 1994 cost report, consistent with guidelines established by the Division of Medical Assistance.

RATE SETTING METHODS FOR NON-STATE FACILITIES

.0304 RATE SETTING METHOD FOR NON-STATE FACILITIES

(a) A prospective rate shall be determined annually for each non-state facility to be effective for dates of service for a 12 month rate period beginning each July 1. The prospective rate shall be paid to the provider for every Medicaid eligible day during the applicable rate year. The prospective rate may be determined after the effective date and paid retroactively to that date. The prospective rate is based on the base year period to be selected by the state. The prospective rate may be changed due to a rate appeal under Section .0308 of this State Plan or facility reclassification under Paragraph (b) of this Section. Each non-state facility, except those facilities where Paragraph (v) of this Section applies, shall be classified into one of the following groups:

- (1) Group 1-Facilities with 32 beds or less.
- (2) Group 2-Facilities with more than 32 beds.
- (3) Group 3-Facilities with medically fragile clients. For rate reimbursement purposes under this Section medically fragile clients are defined as any individual with complex medical problems who have chronic debilitating diseases or conditions of one or more physiological or organ systems which generally make them dependent upon 24-hr a day medical/nursing/health supervision or intervention.
- (4) Facilities in group 1 or 2 in Subparagraph (a)(1) or (2) of this Section shall be further classified in accordance to the level of disability of the facility's clients, as measured by the Developmental Disabilities Profile (DDP) assessment instrument. A summary of the levels of disability is shown in the following chart:

FACILITY DDP SCORE

Level	Low	High
1	200.00	300.00
2	125.00	199.99
3	100.00	124.99
4	75.00	99.99
5	50.00	74.99

- (b) Facilities shall be reclassified into appropriate groups as defined in Paragraph (a) of this Section.
- (1) When a facility is reclassified, the rate shall be adjusted retroactively back to the date of the event that caused the reclassification. This adjustment shall give full consideration to any reclassification based on the change in facts or circumstances during the year. Overpayments related to this retroactive rate adjustments shall be repaid to the Medicaid program. Underpayments related to this retroactive rate adjustment shall be paid to the provider.

- 
- (2) The provider shall be given the opportunity to appeal the merits of the reclassification of any facility, prior to any decision by the Division of Medical Assistance.
  - (3) The provider shall be notified in writing 30 days before the implementation of new rates resulting from the reclassification of any facility.
  - (4) The providers and the Division of Medical Assistance shall make every reasonable effort to ensure that each facility is properly classified for rate setting purposes.
  - (5) A provider shall file any request for facility reclassification in writing with the Division of Medical Assistance no later than 60 days subsequent to the proposed reclassification effective date.
  - (6) For facilities certified prior to July 1, 1993, the facility DDP score calculated for fiscal year 1993 shall be used to establish proper classification at July 1, 1995.
  - (7) For facilities certified after June 30, 1993, the most recent facility DDP score shall be used to establish proper classification.
  - (8) A facility reclassification review shall use the most current facility DDP score.
  - (9) A facility's DDP score shall be subject to independent validation by the Division of Medical Assistance.
  - (10) A new facility that has not had a DDP survey conducted on its clients shall be categorized as a level 2 facility for rate setting purpose, pending completion of the DDP survey. Upon completion of the DDP survey, the facility shall be subject to reclassification and rates shall be adjusted retroactively back to the date of certification. Overpayments related to this retroactive adjustment shall be paid to the Medicaid program. Underpayments related to this retroactive rate adjustment shall be paid to the provider.
- (c) Facility rates under this Section shall be established at July 1, 1995, under the following:
- (1) For facilities certified prior to July 1, 1993, rates shall be derived from the 1993 cost reports.
  - (2) For facilities certified during fiscal year 1993-1994, the fiscal year 1994 facility specific cost report shall be used to derive rates.
  - (3) For facilities certified during fiscal year 1994-1995, the fiscal year 1995 facility specific cost report shall be used to derive rates.
    - (A) Rates for these facilities shall not be adjusted, except for the impact of inflation under Paragraph (k) of this Section, until the fiscal year 1995 cost report has been properly reviewed. Rates for these facilities shall be adjusted retroactively back to July 1, 1995, once the fiscal year 1995 facility specific cost report has been properly reviewed. Overpayments related to this retroactive rate adjustment shall be repaid to the Medicaid program. Underpayments related to this retroactive rate adjustment shall be paid to the provider.

- 
- (4) Facilities with rates established during a rate appeal proceeding with the Division of Medical Assistance during fiscal years 1994 or 1995 shall not have their rates established in accordance with Subparagraph (c)(1), (c)(2), or (c)(3) of this Section.
- (A) The rates for these facilities shall remain at the level approved in the rate appeal proceeding adjusted only for inflation, as reflected in Paragraph (k) of this Section.
- (d) For facilities certified after June 30, 1993, rates developed from filed cost reports for fiscal years subsequent to 1993 may be retroactively adjusted if there is found to exist more than a two percent difference between the filed per diem cost and either the desk audited or field audited per diem cost for the same reporting period. Rates developed from desk audited cost reports may be retroactively adjusted if there is found to exist more than a two percent difference between the desk audited per diem cost and the field audited per diem cost for the same reporting period. The rate adjustment may be made after written notification to the provider 30 days prior to implementation of the rate adjustment.
- (e) Each prospective rate developed in accordance with Subparagraph (c)(1),(c)(2), or (c)(3) of this Section consists of the sum of two components as follows:
- (1) Indirect care rate
  - (2) Direct care rate.
- (f) A uniform industry wide indirect care rate shall be established for each facility category shown under Subparagraph (a)(1), (a)(2), or (a)(3) of this Section.
- (1) The indirect rate for group 1 facilities is established at the fiftieth percentile of the following costs incurred by all facilities with six beds or less in the group 1 category, except those related by common ownership or control to more than 40 said facilities:
    - (A) The sum of the cost of property ownership and use (POU), administrative and general (A + G), and operation and maintenance of plant (OMP) as determined by the 1993 base year cost reports.
  - (2) The indirect rate for group 2 facilities is established at the fiftieth percentile of the costs noted in Part (f)(1)(A) of this Section incurred by the group 2 facilities, as determined by the 1993 base year cost reports.
  - (3) The indirect rate for group 3 facilities is established at the fiftieth percentile of the costs noted in Part (f)(1)(A) of this Section incurred by the group 3 facilities, as determined by the 1993 base year cost reports.
  - (4) The Group 1 facilities related by common ownership or control to more than 40 said facilities shall receive the same indirect rate as other Group 1 facilities.
  - (5) The indirect rates established under Subparagraphs (f)(1), (f)(2), and (f)(3) of this Section shall be reduced as determined based on industry cost analysis by an amount not to exceed four percent to account for expected operating efficiencies.
  - (6) The category specific indirect rate is established by determining the sum of the POU,



---

A + G, and OMP costs for each facility, dividing this sum by facility bed days to establish a per day indirect cost for all facilities in this category, arranging the per day indirect cost of all facilities in the category in ascending order, and setting the indirect rate for all related facilities at the indirect per diem cost falling at the fiftieth percentile.

(A) Each facility's percentile is calculated by dividing cumulative bed days, of the current facility and all facilities preceding the current facility in the ranking of all facilities, by total bed days of the industry. Therefore, the per diem cost at the fiftieth percentile represents that the cost of service of fifty percent of the bed days is rendered at or below this cost level.

(g) The facility's direct care rate shall be the lower of actual direct care per diem cost (actual cost divided by total bed days) or the per diem limit, as calculated in paragraph (g)(7).

(1) Direct care costs for facilities certified prior to July 1, 1993, shall be based on direct care costs reflected in the 1993 cost reports.

(2) The direct care costs for all facilities certified on or after July 1, 1993, are based on the first facility specific cost report filed after certification.

(3) Based on said cost report, the direct care cost is equal to the sum of all allowable costs reflected in the ICF-MR cost report cost centers, as included in the ICF-MR format effective July 1, 1993, except for the following indirect cost centers:

(A) Property ownership and use

(B) Operational and maintenance of plant and housekeeping -non-labor

(C) Administrative and general

(4) The fiftieth percentile cost limit shall be reduced by one percent each year, for the four year period beginning July 1, 1996, in order to account for expected operating efficiencies, as determined based on industry cost analysis.

(5) The fiftieth percentile cost limit shall be increased each year by price level changes calculated in accordance with Paragraph (k) of this Section.

(6) A direct care limit is established for each facility classification as established under Paragraph (a) of this section. A facility's classification is based on its size or medically fragile clients, per Subparagraphs (a)(1), (a)(2), and (a)(3), and based on the level of disability of the facility's clients, per Subparagraph (a)(4).

(7) The facility-specific classification, as determined under Paragraph (a) of this section, direct care cost limit is established by determining the sum of the direct costs for each facility, dividing the sum by facility bed days to establish a per day direct care cost of all facilities in the classification, arranging the per day direct care cost of all facilities in the classification in ascending order, and setting the direct care cost limit for all related facilities at the direct care per diem cost falling at the fiftieth percentile.

(A) Each facility's percentile is calculated by dividing cumulative bed days, of the current facility and all facilities preceding the current facility in the ranking of

- 
- all facilities, by total bed days for the industry. Therefore, the per diem cost at the fiftieth percentile represents that the cost of service of fifty percent of the bed days is rendered at or below this cost level.
- (8) The enhanced rate increase provided effective July 1, 2004, with the implementation of an assessment, will be applied completely to the direct care component of the ICF-MR rate and be settled as such.
- (h) The indirect rate shall not be subject to cost settlement.
- (1) Costs above the indirect rates shall not be paid to the provider.
- (2) Costs savings below the indirect rate shall not be recouped from the provider.
- (i) The direct care rate shall be subject to cost settlement, based on the cost report, subject to audit, filed with the Division of Medical Assistance.
- (1) Cost above the direct rate shall not be paid to the provider.
- (2) Cost savings below the direct rate shall be recouped from the provider.
- (j) Facilities with rates established during a rate appeal proceeding with the Division of Medical Assistance during fiscal years 1994 or 1995 may choose to cost settle under the provisions of Paragraphs (h) and (i) of this Section, or under the following procedure:
- (1) If, during a cost reporting period, total allowable costs are less than total prospective payments, then a provider may retain one-half of said difference, up to an amount of five dollars (\$5.00) per patient day. The balance of unexpended payments shall be refunded to the Division of Medical Assistance. Costs in excess of a facility's total prospective payment rate are not reimbursable.
- (2) The facilities subject to the Paragraph shall make the election on cost settlement methodology on or before the filing of the annual cost report with the Division of Medical Assistance.
- (3) An election to follow the cost settlement procedures of Paragraph (h) and (i) of this Section shall be irrevocable.
- (4) Rates established for these facilities during future rate appeal proceedings shall be subject to the cost settlement procedures of Paragraphs (h) and (i) of this Section.
- (k) To compute each facility's current prospective rate, the direct and indirect rates established by Paragraphs (f) and (g) of this Section shall be adjusted for price level changes since the base year. No inflation factor for any provider shall exceed the maximum amount permitted for that provider by federal or state law and regulations. Notwithstanding any other provision, if specified these rates will be adjusted as shown on Supplement 1 to the 4.19-D section of the state plan.
- (1) Price level adjustment factors are computed using aggregate costs in the following manners:
- (A) Costs shall be separated into three groups:
- (i) Labor,
- (ii) Non-Labor,
- (iii) Fixed.
- (B) The relative weight of each cost group is calculated to the second decimal point by dividing the total costs of each group (labor, nonlabor, and fixed) by the total cost of the three categories.
- (C) Price level adjustment factors for each cost group shall be established as follows:

- 
- (i) Labor. The percentage change for labor costs is based on the projected average hourly wage of North Carolina service workers. Salaries for all personnel shall be limited to levels of comparable positions in state owned facilities or levels specified by the Division of Medical Assistance.
  - (ii) Nonlabor. The percentage change for nonlabor costs is based on the projected annual change in the implicit price deflator for the Gross National Product as provided by the North Carolina Office of State Budget and Management.
  - (iii) Fixed. No price level adjustment shall be made for this category.
- (D) The weights computed in Part (k)(1)(B) of this Section shall be multiplied by the rates computed in Part (k)(1)(C) of this Section. These weighted rates shall be added to obtain the composite inflation rate to be applied to both the direct and indirect rates.
- (2) If necessary, the Division of Medical Assistance shall adjust the annual inflation factor or rates in order to prevent payment rates from exceeding upper payment limits established by Federal Regulations. Effective July 1, 2001, the price level adjustment factors calculated in (k) (1) (D) of this Section shall not exceed that approved by the North Carolina General Assembly.
- (l) Effective July 1, 1995, any rate reductions resulting from the State Plan Amendment 95-03 shall be implemented based on the following deferral methodology:
- (1) Rates shall be reduced for the excess of current rates over base year costs plus inflation.
  - (2) Rates shall be reduced a maximum of 50 percent of the fiscal 1996 inflation rate for the excess of actual costs over applicable cost limits. This reduction shall result in the facility receiving at a minimum 50 percent of the 1996 inflation rate. Any excess reduction shall be carried forward to future years.
  - (3) Total reduction in future years related to the excess reduction carried forward from Subparagraph (1)(2) of this Section, shall not exceed the annual rate of inflation. This reduction shall result in the facility receiving at minimum the rate established in Paragraph (1)(2) of this Section. Any excess reduction shall be carried forward to future years, until the established rate equals that generated by Paragraphs (f),(g), and (k) of this Section.
  - (4) Rates calculated based on Subparagraphs (1)(2) and (3) of this Section shall be cost settled based on the provisions of Subparagraphs (j)(1) of this Section until the fiscal year that the facility receives full price level increase under Paragraph (k) of this Section.
    - (A) A provider may make an irrevocable election to cost settle under the provisions of Paragraphs (h) and (i) of this Section during the deferral period.
    - (B) Once the rates calculated based on Subparagraphs (1)(2) and (3) of this Section reach the fiscal year that the facility receives the full price level increase under Paragraph (k), then said fiscal year's rates shall be cost settled based on Paragraphs (h) and (i) of this Section.
    - (C) Chain providers are allowed to file combined cost reports, for cost settlement purposes, for facilities that use the same cost settlement methodology and have the same uniform rate.
    - (D) A provider may request from the Division of Medical Assistance permission to continue cost settlement under Subparagraph (j)(1) of this Section after the deferral period expires. Said request shall be made each year, 30 days prior to the

cost report due date.

(m) The initial rate for facilities that have been awarded a Certificate of Need is established at the lower of the fair and reasonable costs in the provider's budget, as determined by the Division of Medical Assistance, or the projected costs in the provider's Certificate of Need application, adjusted from the projected opening date in the Certificate of Need application to the current rate period in which the facility is certified based on the price level change methodology set forth in Paragraph (k) of this Section, or the rate currently paid to the owning provider, if the provider currently has an approved chain rate for facilities in the related facility category. The rate may be rebased to the actual cost incurred in the first full year of normal operations in the year an audit of the first year of normal operation is completed.

- (1) In the event of a change in ownership, the new owner receives no more than the rate of payment assigned to the previous owner.
- (2) Except in cases wherein the provider has failed to file supporting information as requested by the Division of Medical Assistance, initial rates shall be granted to new enrolled facilities no later than 60 days from the provider's filing of properly prepared budgets and supporting information.
- (3) The initial rate for a new facility shall be applicable to all dates of service commencing with the date the facility is certified by the Medicaid Program.
- (4) The initial rate for a new facility shall not be entered into the Medicaid payment system until the facility is properly enrolled in the Medicaid program and a Medicaid identification number has been assigned to the facility by the Division of Medical Assistance.

(n) A provider with more than one facility may be allowed to recover costs through a combined uniform rate for all facilities.

- (1) Combined uniform rates for chain providers shall be approved upon written request from the provider and after review by the Division of Medical Assistance.
- (2) In determining a combined uniform rate for a chain provider, the weighted average chain rate is calculated as follows:
  - (A) For each facility, multiply the facility-specific rate, calculated in accordance with paragraphs (f) and (g) and all other provisions of this plan, by facility-specific number of beds.
  - (B) Add products of calculations in Item A.
  - (C) Divide sum of Item B by total number of beds of all facilities included in item A. This is the weighted average chain rate.
- (3) A chain provider with facility(s) that fall under Paragraphs (h) and (i) of this section and with facility(s) that fall under Subparagraph (1)(4) of this Section may elect to include **all** the facilities in a combined cost report and elect to cost settle under either Paragraphs (h) and (i) or Subparagraph (1)(4). The cost settlement selection shall be made each year, 30 days prior to the cost report due date.

(o) Each out-of-state provider shall be reimbursed at the lower of the applicable North Carolina rate,.

---

as established by this plan for in-state facilities, or the provider's per diem rate as established by the state in which the provider is located. An out-of-state provider is defined as a provider that is enrolled in the Medicaid program of another state and provides ICF-MR services to a North Carolina Medicaid client in a facility located in the state of enrollment. Rates for out-of-state providers are not subject to cost settlement.

- (p) Under no circumstances shall the Medicaid per diem rate exceed the private pay rate of a facility.
- (q) Should the Division of Medical Assistance be unable to establish a rate for a facility, based on this Section and the applicable facts known, the Division of Medical Assistance may approve an interim rate.
  - (1) The interim rate shall not exceed the rate cap established under this Section for the applicable facility group.
  - (2) The interim rate shall be replaced by a permanent rate, effective retroactive to the commencement of the interim rate, by the Division of Medical Assistance, upon the determination of said rate based on this Section and the applicable facts.
  - (3) The provider shall repay to the Division of Medical Assistance any overpayment resulting from the interim rate exceeding the subsequent permanent rate.
- (r) In addition to the prospective per diem rate developed under this Section, effective July 1, 1992, an interim payment add on shall be applied to the total rate to cover the estimated cost required under Title 29, Part 1910, Subpart 2, Section 1910.1030 of the Code of Federal Regulations. The interim payment add-on is based on a cost model developed from an analysis of the incremental costs associated with this program. Total incremental costs from the cost model divided by total bed days yields the interim per diem add-on. The interim rate shall be subject to final settlement reconciliation with reasonable cost to meet the requirements of Section 1910.1030. The final settlement reconciliation shall be effectuated during the annual cost report settlement process. An interim rate add-on to the prospective shall be allowed, subject to final settlement reconciliation, in subsequent rate periods until cost history is available to include the cost of meeting the requirements of Section 1910.1030 in the prospective rate. This interim add-on shall be removed, upon 10 days written notice to providers, should it be determined by appropriate authorities that the requirements under Title 29, Part 1910, Subpart 2, Section 1910.1030 of the Code of Federal Regulations do not apply to ICF-MR facilities.
- (s) All rates, except those noted otherwise in this Section, approved under this Section are considered to be permanent.
- (t) In the event that the rate for a facility cannot be developed so that it shall be effective on the first day of the rate period, due to the provider not submitting the required reports by the due date, the average rate for facilities in the same facility group, or the facility's current rate, whichever is lower, shall be in effect until such time as the Division of Medical Assistance can develop a new rate.
- (u) When the Division of Medical Assistance develops a new rate for a facility for which a rate was paid in accordance with Paragraph (t) of this Section, the rate developed shall be effective on the first day of the second month following the receipt by the Division of Medical Assistance of the required reports. The Division of Medical Assistance may, upon its own motion or upon application and just cause shown by the provider, within 60 days subsequent to submission of the delinquent report, make the rate retroactive to the beginning of the rate period in question. Any overpayment to the provider resulting from this temporary rate being greater than final approved prospective rate for the facility shall be repaid to the Medicaid Program.

(v) ICF-MR facilities meeting the requirements of the North Carolina Division of Facility Services as a facility affiliated with one or more of the four medical schools in the state providing services on a statewide basis to children with various developmental disabilities who are in need of long-term high acuity nursing care, dependent upon high technology machines (i.e. ventilators and other supportive breathing apparatus), monitors and feeding techniques shall have a prospective payment rate that approximates cost of care. The payment rate may be reviewed periodically, no more than quarterly, to assure proper payment. The prospective payment rate is based on the Division of Medical Assistance's review of the facilities' budgets, cost reports, and other appropriate data, including budgeted costs and bed days. These facilities are paid an interim per diem which is calculated by divided the facility's budgeted costs by the facility's budgeted bed days. A cost settlement at the completion of the fiscal period year end is required. Payments in excess of cost are to be returned to the Division of Medical Assistance.

(A) Upon proper notice and review, the Division of Medical Assistance may establish a prospective rate for said facilities, subject to cost settlement procedures of paragraphs (h) and (i) of this Section.

(w) A special payment in addition to the prospective rate shall be made in the year that any provider changes from the cash basis to the accrual basis of accounting for vacation leave costs. The amount of this payment shall be determined in accordance with Title XVIII allowable cost principles and shall equal the Medicaid share of the vacation accrual that is charged in the year of the change including the cost of vacation leave earned for that year and all previous years less vacation leave used or expended over the same time period and vacation leave accrued prior to the date of certification. The payment shall be made as a lump sum payment that represents the total amount due for the entire fiscal year. An interim payment may be made based on an estimate of the cost of the vacation accrual. The payment shall be adjusted to actual cost after audit.

(x) The annual prospective rate, effective beginning each July 1, for facilities that commenced operations under the Medicaid Program subsequent to the base year used to establish rates, and therefore did not file a cost report for the base year, shall be based on the facility's initial rate, established in accordance with Paragraph (m) of this Section, and the applicable price level changes, in accordance with Paragraph (1) of this Section.

MEDICAL ASSISTANCE  
State: North Carolina

PROSPECTIVE REIMBURSEMENT PLAN FOR ICF-MR FACILITIES  
PAYMENT FOR SERVICES

---

---

(y) Effective for fiscal year beginning on or after fiscal year 1998, installation cost of Fire Sprinkler Systems in an ICF-MR Facility shall be reimbursed in the following manner.

- (1) Upon receipt of the documentation listed in Parts (A) through (E) of this Subparagraph, the Division of Medical Assistance shall reimburse directly to the provider ninety percent of the verified cost.
  - (A) All related invoices.
  - (B) Verification from the Division of Facility Services that the Sprinkler System is needed.
  - (C) Statement from appropriate authorities that the Sprinkler System has been installed.
  - (D) Three bids to install the system.
  - (E) Prior approval from the Division of Medical Assistance for any installation projected to cost more than \$25,000.
- (2) The unreimbursed installation cost shall be reimbursed after audit through the annual Cost Settlement Process. This portion shall be offset by profits, after taking into consideration any indirect profits and direct losses. Any overpayments determined after audit shall be returned to the program by the provider through the annual cost settlement process.
- (3) The installation of the Sprinkler System is Subject to Prudent Buyer Standards contained in the CMS Provider Reimbursement Manual 15.
- (4) The Sprinkler System's installation costs shall be properly recorded on the provider's ICF-MR Cost Report.

(z) ICF-MR Facility Assessment. An adjustment to the ICF-MR Facility payment rate calculated in accordance with section .0304 (f) and (g) is established, effective July 1, 2004, to reimburse Medicaid participating facilities for the provider's assessment costs that are incurred for the care of NC Medicaid residents. No adjustment will be made for the provider's assessment costs that are incurred for the care of private paying residents or others who are not Medicaid eligible.

In accordance with 10A NCAC 22G.0109 (b), assessments are payable monthly and due to the Department of Health and Human Services or designee of the Department by the 15th day of the following month being reported. Facilities shall submit payment and an account of all actual patient days during the month. Failure to provide accurate and timely reporting of days and payment of assessments shall result in 10% reduction in facility rates for Medicaid participating facilities and recoupment per the Department Cash Management Plan. The rate reduction shall remain enforce until all outstanding assessments are paid. Upon payment of outstanding assessments, the 10% rate reduction shall be removed effective as of the date the outstanding assessments are paid in full.

TN No. 11-042  
Supersedes  
TN No. 04-012

Approval Date: 10/20/2011

Eff. Date: 11/01/2011

**Allowable Costs**

---

.0305 Allowable Costs

(a) To be considered allowable, costs shall not exceed fair and reasonable levels as determined by the Division of Medical Assistance, based on the HCFA-15, generally accepted accounting principles, and the preponderance of evidence derived from an in-depth case by case review of all related facts and circumstances, and shall be required to provide necessary client care under the Medicaid Program.

- (1) The cost of goods or services sold to non-Medicaid clients shall be excluded in determining the allowable client related expenses reimbursable under the Medicaid program. If the provider has not determined the cost of such items, the revenue generated from such sales shall be used to offset the total cost of such services.
- (2) Examples of sources of such income items include, but are not limited to:
  - (A) supplies and drugs sold by the facility for use by nonresidents,
  - (B) telephone and telegraph services for which a charge is made,
  - (C) discount on purchases,
  - (D) employee rental of living quarters,
  - (E) cafeterias,
  - (F) meals provided to staff or a client's guest for which there is a charge,
  - (G) lease of office and other space by concessionaires providing services not related to intermediate care facility services,
  - (H) interest income except for income earned on qualified pension funds and income from gifts or grants which are donor restricted.

(b) Except where specific Sections concerning allowability of costs are stated herein, the Division of Medical Assistance shall use as its major determining factor in deciding on the allowability of costs, the Medicare Provider Reimbursement Manual, published by the U.S. Department of Health and Human Services' Health Care Financing Administration (HCFA). Where specific Sections stated herein or in HCFA-15 are silent concerning the allowability of costs, the Division of Medical Assistance shall determine allowability of costs based on a case specific review taking into consideration the reasonableness of said costs and their relationship to client care and generally accepted accounting principles, consistent with this State Plan.

(c) As determined by the Division of Medical Assistance, expenses or portion of expenses reported by an individual facility that are not reasonably related to the efficient and economical provision of care in accordance to the requirements of this Plan, based on the HCFA-15, generally accepted accounting principles, and the preponderance of evidence derived from an in-depth case by case review of all related facts and circumstances, because of either the nature or amount of the item, shall not be allowed.

- (1) Reasonable compensation, as determined by Division of Medical Assistance, of individuals employed by a provider is an allowable cost, provided such employee are engaged in client related functions and that the compensation is reasonable in light of industry historical data. The historical data shall include, but not be limited to, salary levels for similar services in the same market in which the facility is located.



- (2) Payroll records shall be maintained by the provider to substantiate the staffing costs reported to the Division of Medical Assistance. Payroll records shall indicate each employee's classification, hours worked, rate of pay, and the functional area to which the employee was assigned and actually worked. If an employee performs duties in more than one cost center, the provider shall maintain periodic time studies in order to allocate salary and wage costs to the appropriate cost centers as determined by the Division of Medical Assistance. These periodic time studies shall be maintained in accordance with the Medicare Provider Reimbursement Manual.
- (3) The Division of Medical Assistance shall not reimburse costs related to excess staff, based on the HCFA-15, generally accepted accounting principles, and the preponderance of evidence derived from an in-depth case by case review of all related facts and circumstances.
- (4) Compensation for owners is allowable only for duties which the owner is qualified to render and that otherwise would require the employment of another individual in the provision of ICF-MR related services. Said compensation shall be limited to a reasonable amount, as determined by the Division of Medical Assistance, based on the HCFA-15, generally accepted accounting principles, and the preponderance of evidence derived from an in-depth case by case review of all related facts and circumstances, not to exceed that paid in the local market place for similar type duties. Compensation for owners is not allowable where the services are not related to the provision of ICF-MR related services.
  - (d) As determined by the Division of Medical Assistance, costs which are not properly related to client care or treatment, and which principally afford diversion, entertainment or amusement to owners, operators, or employees of the facility shall not be allowed.
  - (e) Costs for any interest expense related to funding expenses in excess of a fair and reasonable amount based on the HCFA-15, generally accepted accounting principles, and the preponderance of evidence derived from an in-depth case by case review of all related facts and circumstances, or penalty imposed by governmental agencies or courts and the costs of insurance policies obtained solely to insure against such penalty, shall not be allowed.
  - (f) Costs of contributions or other payments to political parties, candidates or organizations shall not be allowed.
  - (g) As determined by the Division of Medical Assistance, only that portion of dues paid to any professional association which has been demonstrated to be reasonable in amount and attributable to Medicaid Program related expenditures other than for lobbying or political contributions shall be allowed. The burden of proof shall be on the provider to justify the inclusion of any professional association dues. Association budgets may be considered in determining said justification. At a minimum, the preponderance of evidence must show a benefit to the providers' operations from membership in the association.
  - (h) Any cost of the sale, purchase, alteration, construction, rehabilitation or renovation of a physical plant or interest in real property shall be considered allowable up to the amount approved by the Division of Medical Assistance. Cost is limited by the applicable provisions of paragraphs (i) and (1) of this Section. Cost is allowable only to the extent it is necessary for the provision of adequate client care under this Plan, as determined by the Department of Health and Human Resources.

---

Cost, and the associated financing, equal to or greater than ten thousand (\$10,000) related to existing facilities or the construction of replacement facilities is subject to prior Division of Medical Assistance approval. Providers shall not incur said costs in a piece meal fashion in order to avoid the ten thousand (\$10,000) limit. Failure to acquire prior approval shall result in the disallowance of said cost from Medicaid reimbursement, unless failure to acquire prior approval was caused by reasons beyond the control of the provider.

- (1) The provider shall file the necessary documentation to support the justification for the proposed expenditure and related financing with the Division of Medical Assistance no later than ninety (90) days prior to the proposed transaction's commencement date.
- (2) The Division of Medicaid Assistance shall render a decision in writing to the provider on the propriety of the proposed transaction no later than thirty (30) days prior to the proposed transaction's commencement date.
- (3) The time requirements of Subparagraphs (h)(1) and (2) of this Section shall be altered, by the Division of Medical Assistance with just cause shown that failure to make timely filing was caused by reasons beyond the control of the provider.
- (4) For any transaction resulting in a change of ownership, the valuation of the asset shall be limited to the lesser of the allowable acquisition cost of the assets to the first owner of record who has received Medicaid payment for said asset, less any accumulated depreciation, plus any allowable improvements, or the acquisition cost of the asset to the new owner. Payment of rent by the Medicaid enrolled provider to the lessor of a facility shall constitute Medicaid payments under this Plan.
- (5) Costs (including legal fees, accounting and administrative costs, travel costs, and the costs of feasibility studies) attributable to the negotiation or settlement of the sale or purchase of any capital asset (by acquisition or merger) for which any payment has previously been made under Medicaid, shall not be allowable for reimbursement.
- (6) An exception may be applied by the Division of Medical Assistance to the requirements of either Subparagraph (h)(4) or (5) of this Section, if it can be proven that the change in ownership shall result in increasing the level of care provided to the facility's clients up to the level required by the Division of Facility Services.
  - (A) In order to meet this exception, it shall be proven that the previous facility owner was not providing, and was incapable of providing, adequate client service, as determined by the Department of Human Resources.
  - (B) The burden of proof in supporting this exception is on the provider. The provider shall request, in writing, consideration of this exception from the Division of Medical Assistance.
  - (C) Consideration of this exception may result in the Division of Medical Assistance allowing some or all of the costs in Subparagraph (h)(5) for Medicaid reimbursement.

- (D) Consideration of this exception may result in the Division of Medical Assistance allowing a substitute valuation as determined on a case by case basis and based on the preponderance of evidence for the transferred property under Subparagraph (h)(4) that is greater than the limit noted, but in no instance greater than the acquisition cost of the assets to the new owner.
- (i) A facility's annual rental payments for real property may be considered an allowable cost subject to the following conditions and the limits included in Paragraph (i)(1) of this Section:
- (1) The lease is reviewed by and acceptable to the Division of Medical Assistance.
    - (A) The lease shall not be acceptable if the associated asset(s) are not needed for client care as determined by the Division of Medical Assistance.
    - (B) The lease shall not be acceptable if alternate means of financing is deemed available and more economical. In making this determination all aspects of the economic impact of the lease shall be examined including length of lease, the cost of the asset to the owner, and the incremental rate of return provided to the lessor. In addition, the lessee's incremental implicit rate of interest and financial position shall be considered.
    - (C) The test of reasonableness shall take into account the agreement between the owner and the tenant regarding the payment of related property costs.
    - (D) Absent clear justification to the contrary, material capital improvements to leased property that are necessary to maintain the asset in its ordinary state of usability at the commencement of the lease, shall be the responsibility of the lessor. Examples of said costs are roof or utility service replacement due to reasons beyond the prudent control of the lessee.
    - (E) Effective July 1, 1993, requests for prior approval of new leases and lease renewals must be submitted whenever possible at least 120 days prior to the last date for the exercise of the lease or lease renewal option. HUD leases with individual ICF-MR clients are not subject to this requirement.
    - (F) Failure to acquire prior approval of leases and lease renewals shall result in the disallowance of said cost from Medicaid reimbursement, unless failure to acquire prior approval was caused by reasons beyond the control of the provider.
  - (2) The lease shall be considered an arm's-length transaction in accordance with Medicare Principles of Reimbursement as contained in the HCFA-15. Leases failing the HCFA-15 arm's-length transaction test shall be reimbursed at the leased asset's reasonable cost of depreciation, interest, if any, and other related expenses, including but not limited to reasonable maintenance costs, as determined by the Division of Medical Assistance. It is the responsibility of the provider to maintain auditable records to document these ownership costs to the Division of Medical Assistance or its designated contract auditors. Undocumented costs will be disallowed.
  - (3) The lease amount is comparable to similar leases for properties with similar functions in the same geographical area.

- 
- (4) The lease agreement between unrelated parties shall include the provision that the amount of rental to be paid by the lessee to the lessor shall not, in any event, exceed the amount approved by the Division of Medical Assistance.
- (j) Depreciation shall be an allowable cost when based upon factors of historical costs and useful life. Depreciation shall be subject to the provisions of this Paragraph and Subparagraph (j)(1) of this Section. For the purpose of this Section:
- (1) Unless an exception is made by the Division of Medical Assistance, the useful life shall be the higher of the reported useful life or that from the Estimated Useful Lives of Depreciable Hospital Assets (1988 edition). A copy of the Useful Lives of Depreciable Hospital Assets can be obtained by writing to the American Hospital Association, 840 Lake Shore Drive, Chicago, Illinois, 60611. In certain instances, a useful life that is based upon historical experience as shown by documentary evidence and approved by the Division of Medical Assistance may be allowed. Should the provider desire a depreciation rate different from that based on the general rule in Subparagraph (j)(1) of this Section, then said provider shall make the request in writing to the Division of Medical Assistance. Upon review and analysis, the Division of Medical Assistance shall make a determination in writing as to the reasonableness of said request.
  - (2) The depreciation method used shall be the straight-line method.
  - (3) Unless an exception is granted by the Division of Medical Assistance, depreciated rates shall be applied uniformly and consistently in accordance with this State Plan and generally accepted accounting principles. Should the provider discover that depreciation has been improperly recorded in prior years, then the provider shall within 30 days report the error to the Division of Medical Assistance. The impact of the error on the provider's rate shall be fully considered by the Division of Medical Assistance and a rate adjustment may be made, with due cause shown. Failure to record depreciation properly shall result in disallowance for Medicaid reimbursement purposes, unless failure to comply with this provision was caused by reasons beyond the control of the provider.
  - (4) Depreciation paid to the provider by the Medicaid Program shall be prudently used by said provider to meet the financial requirements of providing adequate service to the ICF-MR clients.
    - (A) Payment to related parties for costs disallowed by this plan for Medicaid reimbursement may be considered imprudent use of depreciation reimbursement.
    - (B) Imprudent use of Medicaid reimbursement of depreciation may result in the provider being required by the Division of Medical Assistance to fund the depreciation through a qualified independent entity or disallowance of depreciation for Medicaid reimbursement
  - (5) In order to substantiate depreciation expense for Medicaid reimbursement purposes, the property records shall include, at a minimum, all of the following, for assets purchased on or after July 1, 1993:
    - (A) The depreciation method used,
    - (B) A description of the asset,

- 
- (C) The date the asset was acquired,
  - (D) The cost of the asset,
  - (E) The salvage value of the asset,
  - (F) The depreciation cost,
  - (G) The estimated useful life of the asset,
  - (H) The depreciation expense each year,
  - (I) The accumulated depreciation.
- (6) The recovery of losses associated with the disposal or abandonment of assets used to provide necessary services to the Medicaid program shall be determined on a case-by-case basis. Requests for recovery shall be made in writing and are subject to prior Division of Medical Assistance approval. Failure to acquire approval shall result in the disallowance of said costs, unless failure to acquire approval was caused by reasons beyond the control of the provider.
- (7) The treatment of gains associated with the disposal of assets used to provide necessary services to the Medicaid program shall be based on this plan and the Medicare Principles of Reimbursement as contained in the HCFA-15.
- (k) Interest cost may be considered an allowable cost subject to the following conditions, and the limits included in paragraph (k)(1) of this section:
- (1) Interest for capital indebtedness, where the interest expense results from the initial financing of the capital indebtedness and the capital indebtedness represents all or part of the current Division of Medical Assistance approved value of the property. The property shall be necessary for the provision of adequate service, as determined by the Department of Human Resources, to the clients of the ICF-MR facility. The financing shall be prudently incurred, based on the HCFA-15, generally accepted accounting principles, and the preponderance of evidence derived from an in-depth case by case review of all related facts and circumstances.
  - (2) The interest rate shall not be in excess of the amount a prudent borrower would pay at the time the loan was incurred. In determining the reasonableness of the interest rate, all associated factors at the time the loan was incurred shall be considered, including, but not limited to the following:
    - (A) Current market rates of interest in the economy.
    - (B) Industry specific rates of interest.
    - (C) Provider specific financial position.
  - (3) The loan agreement shall be entered into between parties not related through control, ownership, affiliation, or personal relationship as defined in the Medicare Principles of Reimbursement as reflected in the HCFA-15, unless this provision is waived in writing by the Division of Medical Assistance. Such waiver shall be based on, but not limited to, a demonstration of need for the indebtedness and cost savings resulting from the transaction. The burden of proof shall be on the provider to provide proper support and justification for such waiver to the Division of Medical Assistance. Loans from a related party must be clearly identified and reported separately on the annual cost report.

- 
- (4) Interest expense on working capital indebtedness is allowable, subject to the Division of Medical Assistance's approved level of working capital, based on the HCFA-15, generally accepted accounting principles, and the preponderance of evidence derived from an in-depth case by case review of all related facts and circumstances.
    - (A) Interest on excess working capital is specifically denied.
    - (B) Working capital shall be established at the level necessary to support the facility's operations, after taking into full consideration the lead/lag impact of the facility's expenditures and reimbursements.
  - (5) Interest expense for capital indebtedness where the interest expense results from the refinancing of the capital indebtedness, and the refinancing has the prior approval of the Division of Medical Assistance, shall be allowed in that amount associated with the outstanding principal prior to refinancing. Interest costs may be allowed in excess of the amount associated with the outstanding principal balance prior to refinancing, if the purpose of the debt is to acquire assets to be used for care of persons served by the facility and all other applicable requirements of this plan are met. Interest expense resulting from the inclusion of the closing costs, such as, but not limited to, attorney's fees, recording costs and points in the refinancing transaction shall be considered allowable.
    - (A) The provider should file all necessary documents supporting its request for refinancing prior approval to the Division of Medical Assistance no later than 120 days prior to the proposed refinancing date.
    - (B) The Division of Medical Assistance shall render a decision regarding the prior approval request no later than thirty (30) days prior to the proposed refinancing date.
    - (C) Based upon just cause shown, the Division of Medical Assistance may waive the time requirements included in parts (k)(5)(A) and (B) of this Section, but in all cases there shall be enough time allowed to evaluate the proposed refinancing.
  - (6) In all cases, in order for the interest expense to be allowable it shall be necessary to satisfy a financial need related to the adequate provision of recipient care, as determined by the Division of Medical Assistance. Loans which result in excess funds or investments are not considered necessary.
  - (7) Interest expense shall not be allowable when related to loans that failed to receive prior approval, as required, from the Division of Medical Assistance, unless failure to acquire prior approval was caused by reasons beyond the control of the provider.
  - (8) In no event shall interest expense be allowed on a facility's cost that is deemed to be excessive.
  - (l) The annual capital cost or lease expense limitations shall apply:
    - (1) To all facilities with twenty-one (21) or more beds and to facilities consisting of multiple detached buildings in which at least one contains nine (9) certified beds. The facilities covered by this limit shall have been awarded a Certificate of Need before January 1, 1993. The annual capital cost or lease expense limit shall be the lesser of actual cost or

the sum of (A) and (B) as follows:

- (A) The annual depreciation on plant and fixed equipment that would be computed on assets equal to thirty thousand dollars (\$30,000) per bed (capital recovery base) during fiscal year 1982-83 adjusted for changes in the following cost indexes:
  - (i) For the period after 1982-83 and through the period 1991-92 the capital recovery base shall be adjusted for changes in the Dodge Building Cost Index of North Carolina Cities.
  - (ii) For the period beginning July 1, 1992 the capital recovery base shall be adjusted for changes in the implicit price deflator for residential structures as provided by the Office of State Budget and Management. Depreciation expense shall be computed using the straight line method of depreciation and the useful life standards established by the American Hospital Association.
- (B) An interest allowance equal to ten percent (10%) of the capital recovery base used to compute annual depreciation on plant and fixed equipment.
- (C) This annual capital cost or lease expense limit does not apply to leases in effect prior to August 3, 1983.
- (2) To all facilities that have been awarded a Certificate of Need on or after January 1, 1993, the annual capital cost or lease expense shall be limited to the lesser of actual cost or the fair and reasonable depreciation and interest at the time of certification and enrollment into the Medicaid program.
  - (A) Depreciation expense shall be computed using the straight line method of depreciation and the useful life standards established by the American Hospital Association.
  - (B) Interest expense is computed using a ten percent (10%) rate of interest.
  - (C) The capital recovery base is established as thirty thousand dollars (\$30,000) of plant and fixed equipment assets per bed during the fiscal year 1982-83 adjusted for the changes in the cost indexes contained in subparagraphs (1)(1)(A),(i) and (ii) of this Section.
- (D) Recovery of the cost of material additions to plant and fixed equipment subsequent to certification and enrollment in the Medicaid program shall be subject to review on a case by case basis, consistent with the provisions of this State Plan.
- (E) The capital cost or lease expense limitation should be considered the absolute maximum allowable for Medicaid reimbursement. In evaluating the reasonableness of a particular facility's capital cost or lease expense, regional costs of land and construction should be considered. In cases where the reasonable regional costs are less than those derived from subparagraph (1)(2)(C) of this Section, above, then the regional costs should be used in determining the appropriate capital cost or lease expense limitations.

- (i) In determining fair and reasonable facility cost, the average cost of similar construction in the same local area should be used. This test of reasonableness should be applied to all components of the facility's construction cost, including square footage and per unit costs.
- (ii) Absent strong, clear justification to the contrary, no six (6) bed facility shall be allowed to recover capital cost and lease expense related to square footage in excess of 3200 square feet.
- (3) Failure to provide supporting evidence of actual facility cost incurred shall result in disallowance of said cost unless failure to provide the information was caused by reasons beyond the control of the providers.
- (m) For providers whose annual reimbursement from the Medicaid program exceeds one million dollars (\$1,000,000), all contracts with related parties as defined in the Medicare Principles of Reimbursement as reflected in the HCFA-15, in the amount of ten thousands dollars (\$10,000) or more shall receive prior approval from the Division of Medical Assistance.
  - (1) Failure to file said contracts with the Division of Medical Assistance shall result in disallowance of the related cost from Medicaid reimbursement, unless failure to file said contracts was caused by reasons beyond the control of the provider.
  - (2) The contracts shall be filed with the Division of Medical Assistance ninety (90) days prior to the effective date of said contracts.
- (n) "Donations," for purposes of this Section, shall mean grants, gifts, or income from endowments, cash or otherwise, given to a provider by a donor. "Unrestricted donations" shall mean donations given without restrictions by the donor as to their use. "Restricted donations" shall mean donations which the donor has specified the provider must use only for a specific purpose or within a specific time period designated by the donor, and shall not mean donations which the provider has restricted or designated for use for a specific purpose or within a specific time period.
  - (1) Providers are encouraged to raise donations to support their operations. Absent evidence to the contrary, donations shall be presumed used to support Medicaid program costs.
  - (2) Restricted donations for which the donor has specified a time period for the use of the donation shall be deemed to have been applied to support the provider's costs within the donor-specified time period.
  - (3) Unrestricted donations or restricted donations without a donor-specified time period for use shall be presumed to have been applied to support the provider's costs in the year in which such donations were acquired, unless the provider demonstrates otherwise by, without



limitation, the following factors:

- (A) The documented decision of the Board of Directors or management as to the time for use of the funds.
  - (B) The provider's supporting documentation, including general ledger accounting, regarding the time period in which the donations were used.
- (4) In determining whether non-Medicaid program costs are supported by donations, the following factors, without limitation, shall be considered:
- (A) The decision of the provider's Board of Directors or management regarding the use of unrestricted donations.
  - (B) The donor's specifications, in cases of restricted donations.
  - (C) The provider's supporting documentation, including general ledger accounting, regarding use of donations.
- (5) Costs included in the provider's Medicaid cost report which are supported by donations shall be reduced by the net value of the donations.
- (A) The "net value" of a donation shall mean the fair market value of the donation minus the provider's reasonable costs of acquiring the donation.
  - (B) Reasonable costs of acquiring donations are those costs incurred by an economic and efficient provider.
  - (C) The provider's general ledger and supporting documents shall support the provider's reported cost of acquiring donations.
  - (D) The net value of a provider's donations shall not be less than zero.
- (o) When multiple facilities or operations are owned by a single entity with a central office, the central office records shall be maintained as a separate set of records with costs and revenues separately identified and appropriately allocated to individual facilities. Allocation of central office costs shall be reasonable and conform to the directives of the Division of Medical Assistance and generally accepted accounting principles. Such costs are allowable only to the extent that the central office is providing services related to client care and the provider can demonstrate that the central office costs improved efficiency, economy, or quality of recipient care. The burden of demonstrating that costs are client related lies with the provider.

- 
- (1) If a provider has business enterprises other than those reimbursed by Medicaid, then the revenues, expenses, statistical and financial records for such enterprises shall be clearly identifiable from the records of the operations reimbursed by Medicaid.
  - (2) If an audit establishes that records are not maintained so as to clearly identify Medicaid information, none of the co-mingled costs shall be recognized as Medicaid allowable costs and the provider's rate shall be adjusted to reflect the disallowance as of the earlier of the commencement of the rate period related to the co-mingled costs, or the commencement of the co-mingling of said costs.
  - (3) After the co-mingled costs have been satisfactorily allocated and reported to the Division of Medical Assistance, and based on a showing by the provider that procedures have been implemented to insure that the co-mingling will not occur in the future, the Division of Medical Assistance shall retroactively adjust the facility's rate.
  - (4) Central office costs are generally charged to the Administrative and General cost center. In some cases, however, personnel costs which are direct patient care oriented may be allocated to direct care cost centers if time records are maintained to document the performance of direct patient care services. No home office overhead may be so allocated. The basis of this allocation among facilities participating in the North Carolina Medicaid program may be:
    - (A) specific time records of work performed at each facility,
    - (B) client days in each facility to which the costs apply relative to the total client days in all the facilities to which the costs apply, or
    - (C) any other allocation method approved by the Division of Medical Assistance, based on the HCFA-15, generally accepted accounting principles, and the preponderance of evidence of a case-by-case review.
- (p) All criteria and limitations used by the Division of Medical Assistance to subject individual provider cost data to tests of reasonableness shall be based on the HCFA-15, generally accepted accounting principles, and the preponderance of evidence derived from an in-depth case by case review of all related facts and circumstances. In determining reasonableness of costs, the Division of Medical Assistance may compare major cost centers or total costs of similar providers and may request satisfactory documentation from providers whose cost do not appear to be reasonable. Similar providers are those with like levels of client care, size, and geographic location.
- (q) Start-up costs are costs incurred by an ICF-MR facility while preparing to provide services at said facility. They include the cost incurred by providers to provide services at the level necessary to obtain certification less any revenue or grants related to start-up. The North Carolina Medicaid Program shall reimburse these start-up costs up to a maximum equal to the facility's initial rate, determined under Section .0304 (m), times certified beds times 120 days.
- (1) Effective for all facilities whose Certificate of Need was granted on or after January 1, 1993, start-up costs shall be amortized over a thirty-six (36) month period and shall be reported as administrative and general in the cost report. No advance of these start-up costs shall be made. These costs shall not be included in calculating the facility's total AG/OMP costs for rate setting purposes in accordance with this Plan. These costs

shall be paid manually outside of the per diem rate, with equalized payments made each month over the 36 month amortization period.

- (2) Effective for all facilities whose CON was granted prior to January 1, 1993, the start-up reimbursement shall be made in addition to the facility's per diem rate. No advance of start-up funds shall be made prior to the submission of the start-up cost report. An interim payment not to exceed eighty percent (80%) of the allowable start-up costs can be made at the written request of a provider after a start-up cost report has been filed. The remaining balance of appropriately incurred start-up costs shall be paid after the desk audit of the start-up costs report has been completed. These start-up cost payments are made manually outside of the per diem rate. Any balance due to the Medicaid program shall be repaid promptly.
- (3) A start-up cost report shall be filed with the Division of Medical Assistance. A copy of the start-up cost report shall be provided by the Division of Medical Assistance to each newly Medicaid certified facility.
  - (A) A start up cost report shall be filed with the Division of Medical Assistance Audit Section.
  - (B) Schedule E of the start up cost report shall be filed with the Division of Medical Assistance's Rate Setting Section.
- (4) Allowable start-up costs may include, but not be limited to:
  - (A) personal services expenses,
  - (B) utility expenses,
  - (C) property taxes,
  - (D) insurance expenses,
  - (E) employee training expenses,
  - (F) housekeeping expenses,
  - (G) repair and maintenance expenses,
  - (H) administrative expenses.
- (5) All costs that are properly identifiable as organization costs shall be classified as such and excluded from start-up costs.
- (6) Costs related to increasing bed capacity in an existing facility shall not be treated as start-up costs.
  - (r) Only that portion of management fees that is directly related to client care and is not otherwise functionally covered by the current staffing pattern is allowable in the calculation of a facility's actual, allowable, and reasonable costs. Management fees on a per diem basis shall be limited to seven (7) percent of the maximum intermediate care rate for nursing facilities enrolled in the Medicaid Program. Management fees shall be charged to the Administrative and General Cost Center. A portion of a management fee may be allocated to a direct patient care cost center if time records are maintained to document the performance of direct care services.. The amount so allocated may be equal only to the salary and fringe benefits of persons who are performing direct patient care services while

---

employed by the management company. Records to support these costs shall be made available to staff of the Division of Medical Assistance. The basis of this allocation among facilities participating in the North Carolina Medicaid program may be:

- (1) specific time records of work performed at each facility, or
  - (2) client days in each facility to which the costs apply relative to the total client days in all facilities to which the cost apply.
- (s) The following costs are considered non-allowable facility costs because they are not related to client care or are specifically disallowed under the North Carolina State Plan:
- (1) bad debts;
  - (2) advertising, except personnel want ads, and one line yellow page (indicating facility address);
  - (3) charity, courtesy allowances, discounts, refunds, rebates and other similar items granted by the provider;
  - (4) life insurance (except for employee group plans and reasonable key man life insurance premiums required by financial institutions in an outstanding loan agreement);
  - (5) prescription drugs and insulin (available to recipients under the State Medicaid Drug Program);
  - (6) vending machine expenses;
  - (7) state or federal corporate income taxes, plus any penalties and interest;
  - (8) telephone, television, or radio for personal use of client;
  - (9) retainers, unless itemized services of equal value have been rendered;
  - (10) fines or penalties;
  - (11) ancillary costs that are billable to Medicare or other third party payers;
  - (12) property taxes and other expenses related to real estate deemed by the Division of Medical Assistance to be in excess of the reasonable amount needed for the physical facility;
  - (13) property taxes, insurance, maintenance and other expenses related to facility costs deemed by the Division of Medical Assistance to be in excess of the reasonable amount necessary for quality client care;
  - (14) costs associated with lawsuits filed against the Department of Health and Human Services which are not upheld by the courts;
  - (15) personal use of company assets resulting in unreasonable levels of compensation;
  - (16) meals provided to employees not involved in the modeling process required to meet the clients' habilitation plan;
  - (17) charitable contributions;
  - (18) costs, related to excessive or unnecessary levels of care;
  - (19) interest associated with Medicaid overpayment repayment plans agreed to by both the provider and the Division of Medical Assistance;
  - (20) costs related to frivolous appeals;
  - (21) costs resulting from provider negligence;

- (22) costs related to any illegal activity;
  - (23) costs disallowed on the associated tax return by the Internal Revenue Service, or the North Carolina Department of Revenue unless specifically allowable under this plan;
  - (24) promotional items designed to promote the provider's public image;
  - (25) costs associated with the interests of provider shareholders and not direct care related;
  - (26) costs related to client care incurred in prior years, unless specific approval acquired from the Division of Medical Assistance; Approval of said costs shall be based on the HCFA-15, generally accepted accounting principles, and the preponderance of evidence on a case-by-case-review;
  - (27) country club dues.
- (t) Providers shall use a competitive bidding process in order to purchase or lease vehicles.
- (1) Providers shall explore cost differentials between leasing and purchasing of vehicles and shall choose the least expensive alternative.
  - (2) Daily logs detailing the use of vehicles shall be maintained by the provider.
- (u) Purchase of services, major renovations, capital equipment, and supplies that exceed five thousand dollars (\$5,000) annually per facility shall be reasonably made consistent with the prudent buyer provisions of the HCFA-15.
- (v) Reasonable costs associated with self-insurance programs are allowable, as determined by the Division of Medical Assistance. All material facts related to said programs shall be disclosed to the Division of Medical Assistance. Failure to disclose shall result in the disallowance of said costs, unless failure to disclose the information was caused by reasons beyond the control of the provider.

**PAYMENT ASSURANCE**

---

**.0306 PAYMENT ASSURANCES**

- (a) The State shall pay each provider of ICF-MR services in accordance with the requirements of the State plan and the Participation agreement, the amount determined under the plan.
- (b) In no case shall the payment rate for services provided under the plan exceed the facility's customary charges to the general public for such services.
- (c) The payment methods and standards set forth herein are designed to enlist the participation of any provider who operates a facility both economically and efficiently. Participation in the program shall be limited to providers of service who accept, as payment in full, the amounts paid in accordance with the State Plan. This reimbursement plan is effective consistent with and on approval of the State Plan for Medical Assistance.
- (d) In all circumstances involving third party payment, Medicaid is the payor or last resort.
- (e) The State may withhold payments to providers under the following circumstances:
  - (1) If the State has an expectation that the provider will not expend the total prospective rate for reasonable and allowable patient care costs, the State may, at its discretion, withhold a portion of each payment so as to avoid a large amount due back to the State.
  - (2) Upon provider termination from the Medicaid Program the State may withhold a sum of reimbursement settlements for all previous periods, including the period in which the termination occurred, are completed.
  - (3) Upon determination of any sum due the Medicaid Program or upon instruction from a legally authorized agent of State or Federal Government, the State may withhold sums to meet the obligations identified.
  - (4) Upon written request of the provider, and with good cause shown, the Division of Medical Assistance may approve a repayment schedule in lieu of withholding funds.
  - (5) The State may withhold up to twenty (20) percent per month of a provider's payment for failure to file a timely cost report or other relevant information related to a facility's operation and requested by the Division of Medical Assistance. These funds shall be released to the provider after the cost report or the related information requested by the Division of Medical Assistance is acceptably filed. The provider shall experience delayed payment while the check is routed to the State and split for the amount withheld.

## REIMBURSEMENT METHODS FOR STATE-OPERATED FACILITIES

---

### .0307 Reimbursement Methods for State-Operated Facilities

(a) A certified State-operated ICF-MR facility is reimbursed for the reasonable costs that are necessary to efficiently meet the needs of its clients and to comply with federal and state laws and regulations. Payments shall be suspended if annual reports are not filed. The Division of Medical Assistance may extend the deadline for filing the report if in its view good cause exists for the delay. The reasonableness and allowability of costs incurred by state-operated facilities shall be determined by the Division of Medical Assistance.

(b) A per diem rate based on the provider's estimated annual cost divided by patient days shall be used to make interim payments. A tentative settlement shall be issued based on the desk audit performed on each annual cost report to determine the amount of Medicaid reasonable cost and the amount of interim payments received by the provider.

(c) Any payments in excess of costs shall be refunded to the Division of Medical Assistance. Any reasonable costs in excess of payments shall be paid to the provider. An annual field audit may be performed by a qualified independent auditor to determine the final settlement amounts.

(d) ICF-MR Facility Assessments: An adjustment to the interim ICF-MR facility payment rate calculated in accordance with paragraph (c) of this section is established, effective July 1, 2004, to reimburse Medicaid participating State-Operated ICF-MR facilities for the provider's assessment costs that are incurred for the care of NC Medicaid residents. No adjustment will be made for the provider's assessment costs that are incurred for the care of private paying residents or others who are not Medicaid eligible.

**RATE APPEALS**

---

.0308           RATE APPEALS

- (a) The Division of Medical Assistance shall consider only the following appeals for adjustment to the rates which would result in an annual rate increase to the provider from the Medicaid Program of one thousand dollars (\$1,000) or more.
- (1) Appeals because of changes in the information used to calculate a facility's prospective rate.
  - (2) Appeals for significant increases or decreases in a facility's overall base period operating costs due to, but not limited to, implementation of new programs, changes in staff or service, changes in the characteristics or number of clients, changes in a financing agreement, capital renovations, expansions or replacements which have been either mandated or approved by the Division of Medical Assistance and, except in life-threatening situations, approved in advance by the applicable State agencies.
  - (3) In order for said changes to be considered, they shall be consistent with all of the provisions of this plan.
  - (4) Upon proper notification to the provider in writing, the Division of Medical Assistance may instigate a proceeding to reduce the provider's rates. A rate reduction proceeding may be initiated upon the determination of just cause by the Division of Medical Assistance. Grounds for just cause may include, but are not limited to, the following:
    - (A) The provider has achieved material over-collections of Medicaid funds derived from the prospective rate being greater than reasonable Medicaid costs.
    - (B) Changes in Federal or State laws or regulations resulting in material operational cost savings.
    - (C) Material changes in client profile resulting in the need for less costly services.
    - (D) The burden of proof shall be on the Division of Medical Assistance to prove the need for said rate reduction.
  - (5) In determining a fair and reasonable rate under appeal, the Division of Medical Assistance shall take into consideration all funds available to the provider from the Medicaid program and patient liability. Providers are expected to utilize all available funds to provide the services that their clients need.
  - (6) Reasonable occupancy factors, based on the HCFA-15, generally accepted accounting principles, and the preponderance of evidence derived from an in-depth case by case review of all related facts and circumstances, shall be utilized in establishing fair and reasonable rates in the appeal process.
  - (7) The Division of Medical Assistance shall not pay interest on the final dollar settlement resulting from the retroactive impact of any rate appeals.



- (b) Notification of appeal:
- (1) In order to appeal a rate the facility shall send to the Division of Medical Assistance an appeal application in writing within 60 days subsequent to the proposed effective date of the appeal rate.
  - (2) The appeal application shall set forth the basis for the appeal and the issues of fact. Appropriate documentation shall accompany the application and the Division of Medical Assistance may request in writing such additional documentation as it deems necessary.
- (c) The burden of proof on appeal shall be on the facility to present clear and convincing evidence to demonstrate the rate requested in the appeal is necessary to ensure efficient and economical operation, and meets the criteria of this State Plan.
- (d) There shall be written notification by the Division of Medical Assistance of the final decision on the facility's rate appeal. However, at no point in the appeal process shall the facility have a right to an interim report of any determinations made by any of the parties to the appeal.

## AUDITS

---

### .0309 AUDITS

(a) Each facility shall maintain the statistical and financial records which formed the basis of the reports required by this plan and submitted to the Division of Medical Assistance for five years from the date on which the reports were submitted or due, whichever is later, or for such longer periods as may be required under State or Federal law. Each cost report shall be verified by the state agency or its representative for completeness, accuracy, and reasonableness through a desk audit. Field audits shall be performed as required. When a combined cost report is filed under this plan, only the combined cost report is subject to desk and field audit, unless the Division of Medical Assistance determines that the supporting individual facility cost reports need to be audited.

(b) All such records shall be subject to audit for a period of five years from the later of the date on which all required reports were filed with the Division of Medical Assistance or the date on which such reports were due.

- (1) Desk or field audits shall be conducted by the Division of Medical Assistance, its designated contract auditors, or other governmental agencies at a time and place and in a manner determined by said governmental agencies.
- (2) The audits may be performed on any financial or statistical records required to be maintained.
- (3) Any findings of any above-described audit shall constitute grounds for recoupment at the discretion of the Division of Medical Assistance, provided that such audit finding relates to the allowable costs.

(c) All filed cost reports shall be desk audited and tentative settlements made in accordance with the provisions of this plan. This settlement is issued within 180 days of the date the cost report was filed or within 272 days of the end of the June 30 fiscal year reflected in the cost report, whichever is later. The state may elect to perform field audits on any filed cost reports within three years of the date of filing and issue a final settlement on a time schedule that conforms to Federal law and regulation. If the state decides not to field audit a facility a final reimbursement notice may be issued based on the desk audited settlement. The state may reopen and field audit any cost report after the final settlement notice in order to comply with Federal law and regulation or to enforce laws and regulations prohibiting abuse of the Medicaid Program and particularly the provisions of this reimbursement plan.

State Plan Under Title XIX of the Social Security Act  
Medical Assistance Program  
State: North Carolina

Payments for Medical and Remedial Care and Services

---

Payment for ICF/MR Services:

SFY 2002 - 2003 – No adjustment

SFY 2003 - 2004 – No adjustment.

SFY 2004 - 2005 – With the implementation of the assessment process and the analysis of justified costs, agreement was reached with the industry to only provide a 1% inflationary increase to be included in the 7% increase in their rates.

SFY 2005 - 2006 – No adjustment

SFY 2006 - 2007 – Effective January 1, 2007, a 7.22% inflationary increase was applied to the Non - State ICF-MR providers. This is a permanent increase in the rates with 1.19% applied to the indirect component and 6.03% applied to the direct component.

State ICF-MR facilities received no inflationary increase for SFY 2006 - 2007.

SFY 2007 - 2008 - Effective November 1, 2007 through June 30, 2008, a 3.91% inflationary increase shall be applied to the Non-State ICF-MR providers. This increase in the rates shall be applied 1.18% to the indirect component and 2.73% to the direct Component.

Effective July 1, 2008 a 2.61% inflationary increase shall be applied to the rate in effect prior to November 1, 2007 for the Non-State ICF-MR providers. This is a permanent increase in the rates with 0.79% applied to the indirect component and 1.82% applied to the direct component.

State ICF-MR facilities received no inflationary increase for SFY 2007 - 2008.

SFY 2008-2009 – Effective December 1, 2008 through May 31, 2009 a 0.00% inflationary increase shall be applied to the rate in effect prior to November 1, 2007 for the Non-State ICF-MR providers. This is a permanent increase in the rates with 0.00% applied to the indirect component and 0.00% applied to the direct component.

Reference - Supplement to Attachment 4.19-D: Addendum ICF-MR Page 10

---

TN. No. 08-018

Supersedes

TN. No. 07-003

Approval Date: 03/12/09

Eff. Date: 12/01/2008

State Plan Under Title XIX of the Social Security Act  
Medical Assistance Program  
State: North Carolina

Payments for Medical and Remedial Care and Services

---

Payment for ICF/MR Services - Continued:

FY 2009-2010 - The rates for SFY2010 are frozen as of the rates in effect July 1, 2009.

FY 2010-2011 – Effective January 1, 2011, an overall rate increase of 8.35% for ICF-MR facilities.

FY 2011-2012 – Rates will be frozen at the rate in effect on June 30, 2011. Effective November 1, 2011, the June 30, 2011 rates will be adjusted by a negative 5.02% to yield a twelve (12) month two percent (2%) budget reduction and to offset the decrease in the FMAP from ARRA to normal in the nine (9) remaining months of this State Fiscal Year. The direct portion of the rate will receive a decrease of 4.41% while the indirect portion will receive a rate decrease of 6.62%.

FY 2012-2013 – Effective July 1, 2012, the rates will be adjusted such that they will equal 96.24% of the rate in effect July 1, 2011 in order to yield a twelve (12) month two percent (2%) budget reduction and to offset the decrease in the FMAP from ARRA to normal. There will be no further annual adjustments this state fiscal year.

Reference - Supplement to Attachment 4.19-D, Addendum ICF-MR Page 10

STATE PLAN UNDER TITLE XIX OF THE SOCIAL SECURITY ACT  
MEDICAL ASSISTANCE PROGRAM

State North Carolina

PAYMENTS FOR MEDICAL AND REMEDIAL CARE AND SERVICES

---

---

Definition of claim:

- a. Pharmacy claim - a single prescription (line item of service) for an individual recipient within a bill.
- b. All other non-institutional provider claims - a bill for services for one recipient. All services furnished to a patient over a period of time may be submitted on a single bill and is one claim.

SENT BY OPC # 79-17

DATED 11-13-79

R.O. ACTION DATE 11-30-79

EFF. DATE 8-23-79

OBSOLETE BY \_\_\_\_\_

DATED \_\_\_\_\_

STATE PLAN UNDER TITLE XIX OF THE SOCIAL SECURITY ACT

State: NORTH CAROLINA

STATE LAWS REQUIRING THIRD PARTIES TO PROVIDE  
COVERAGE ELIGIBILITY AND CLAIMS DATA

1902(a)(25) The Medicaid agency assures that the State has in effect laws requiring third parties to provide the State with coverage eligibility and claims data under 1902(a)(25)(I) of the Act.

---

TN No: 09-003

Supersedes: Approval Date: 02/13/09

Effective Date: 1/01/09

TN No: NEW

STATE PLAN UNDER TITLE XIX OF THE SOCIAL SECURITY ACT

State/Territory: North Carolina

Requirements for Third Party Liability -  
Identifying Liable Resources

1. All data exchanges will be conducted as required by 433.138 (d)(1), (d)(3), and (d)(4) as follows:
  - a. SWICA and SSA application and redetermination and "batch" run with a printout at least quarterly.
  - b. IRS match at application and at least annually.
  - c. Unemployment compensation on line at application and redetermination and "batch" run with printouts at least quarterly.
  - d. Motor vehicle data matches cannot be done in North Carolina at this time. Required data elements are not available for matching from DMV. See Attachments 1 and 2 of the North Carolina TPL action plan for the documentation on attempted matching.

Worker's compensation data matches have not been done at this time. Discussions are underway for this process. We are targeting December 31, 1991 for a completion date.

- e. The Title IV-A agency is a sister agency to Medicaid under the Department of Human Resources and information is shared at application and redetermination time. Information from the applicant/recipient is required to be furnished to the IV-D agency on the absent parent, including SSN, health insurance information, workman's compensation, and unemployment insurance. This information is placed in the case record. IV-D furnishes information on support/court orders for absent and custodial parents and is followed up by the TPL Unit. Data matches with IV-D cannot be accomplished at this time. However, the TPL data base is being modified in order that this can be accomplished. Target date for matching is January 1992. The DEERS match cannot be accomplished until the IV-D interface is made. However, after the accomplishment of the IV-D data match, the DEERS match will be accomplished.

As provided by 433.138(c), trauma claims are identified by the FA and a monthly report is produced by the FA using the required trauma code edits.

TN No. 90-19



STATE PLAN UNDER TITLE XIX OF THE SOCIAL SECURITY ACT

State/Territory: North Carolina

Requirements for Third Party Liability -  
Identifying Liable Resources

2. The methods used for follow-up as required by 433.138 (g)(1)(i) and (g)(2)(i) are:
  - a. The eligibility worker verifies all information, including potential TPL, within thirty (30) days and the TPL information is incorporated into the eligibility case file, the TPL data base and the third party recovery unit.
  - b. Worker's compensation data will be verified and TPL information will be incorporated into the eligibility case file, the TPL data base and the third party recovery unit within thirty (30) days.
  - c. If follow-ups are necessary for 2a or 2b, they will be done by correspondence and/or telephone within sixty (60) days.
3. The Department of Motor Vehicle data is unavailable. See Attachments 1 and 2 of the North Carolina TPL action plan for documentation.
4. All claims paid for a given recipient with an ICD9-CM diagnosis code between 800.00 and 999.99 are accumulated for one month and a system generated inquiry is mailed to the recipient requesting information regarding the possible accident. Information received from the recipient regarding potential TPL is incorporated into the TPL case file within thirty (30) days. Claims are then filed with the potential third party carrier or recipient attorney.

The third party recovery unit will keep records of trauma diagnosis code recoveries and will, at least annually, identify those diagnosis codes that produce the greatest amount of recovery and give those codes priority for follow-up.

STATE PLAN UNDER TITLE XIX OF THE SOCIAL SECURITY ACT

State/Territory: North Carolina

Requirements for Third Party Liability -  
Identifying Liable Resources

- (1) The provider must indicate, in writing, either on the hardcopy claim form or a separate form that he had billed the third party and has not received payment. The TPL unit will verify with the insurance carrier the availability of third party payments and if the payments are available, the TPL unit will bill the third party for reimbursement to the Medicaid program. If the absent or custodial parent is to make medical support payments, in cash, through the clerk of courts office, the TPL unit will bill the absent or custodial parent for medical services on a routine schedule, not to exceed every sixty (60) days if there has been Medicaid payments on behalf of the child(ren). For those absent parents who are court ordered to provide health insurance, the TPL unit will pay and chase the Medicaid claims. If the provider uses electronic billing, the TPL unit will do selective monitoring to verify provider compliance with this regulation. This will be done by selecting a sample of recipients with TPL available and securing the paid claim history for the proceeding three (3) months for these recipients and verify with the third party carrier the information the provider furnished on his claim form.

STATE PLAN UNDER TITLE XIX OF THE SOCIAL SECURITY ACT

State/Territory: North Carolina

Requirements for Third Party Liability -  
Identifying Liable Resources

- (2) The State of North Carolina will pay and chase those claims for prenatal and preventive pediatric services including EPSDT for those recipients that have major medical insurance coverage. The TPL unit will accumulate these claims for a period of six (6) months and bill the major medical carriers for payment. The first billing will be done in January, 1992 for claims paid May 7, 1991 to December 31, 1991. After that, they will be billed to the insurance carrier each July and January for the preceding six (6) months.
- (3) North Carolina does not use a threshold for TPL claims processing. We cost avoid all claims, except those for which we have a waiver, when there is health insurance indicated on the TPL data base and recipient eligibility file.
- (4) All claims for a recipient related to trauma diagnosis code between 800.00 and 999.99 are accumulated for a period of one (1) month and a questionnaire is mailed to that recipient at the end of the month requesting information related to a possible accident and any and all information regarding the liable party and/or the recipient's attorney. See Attachment 3 in the North Carolina TPL Action Plan for a sample copy of the questionnaire.

Revision: HCFA-PM-90-2  
January 1990

(BPD)

Attachment 4.22-B  
Page 3  
OMB No:0938-0193

STATE PLAN UNDER TITLE XIX OF THE SOCIAL SECURITY ACT

State/Territory: North Carolina

Requirements for Third Party Liability -  
Identifying Liable Resources

- (5) North Carolina has a waiver to pay and chase pharmacy claims. We accumulate these claims for a period of six (6) months and bill the respective insurance carrier. Each of our semiannual collections, to date has exceeded \$500,000. Our cost to benefit ratio to cost avoid pharmacy claims is 1:8. Our cost benefit ratio to pay and chase pharmacy claims is 1:11.6.

---

TN No. 91-49  
Supersedes  
TN No. 90-07

Approval Date 2/6/92

Eff. Date 10/1/91

Citation

Conditions or Requirement

1906 of the Act

State Method on Cost Effectiveness of Employer-Based Group Health Plans

I. The State of North Carolina uses the following methods to determine the cost effectiveness of paying group health insurance premiums for Medicaid clients:

1 - Cost Effectiveness Based on Client Diagnosis:

The determination of cost effectiveness is based on the comparison of premium amounts and the policyholder obligations against the anticipated expenditures identified with a diagnosis that will require long term treatment. Such a diagnosis would include cancer, chronic heart disease, congenital heart disease, end stage renal disease and AIDS. This list will be expanded as diagnoses associated with anticipated long term care are targeted. This method of determination is also appropriate for short term high expense treatments such as a pregnancy. A client's case is considered as cost effective when anticipated expenditures associated with the diagnosis exceed the premium amounts and policyholder obligations as the condition is likely to continue.

2 - Cost Effectiveness Based on Actual Expenditures:

The determination of cost effectiveness is based on the comparison of premium amounts and policy holder obligations against the actual claims experience for the client. Documentation of actual expenditures consists of Explanation of Benefits (EOB's) from the client's health carrier for previous charges or Medicaid expenditures for previous periods of the client's eligibility. A client's case is determined as cost effective if actual claim expenditures exceed premium amounts and policyholder obligations.

3 - Cost Effectiveness Based on Expenditure Projections:

The determination of cost effectiveness is based on the comparison of the amount of the annual premium, deductibles, coinsurance, policyholder cost sharing obligations and additional administrative cost against the average annual cost of Medicaid expenditures for the recipient's eligibility classification for types of service covered under a group plan. The Medicaid Management Information System (MMIS) is utilized to obtain the average annual Medicaid cost of a recipient by age, sex, qualifying category and geographical location. A client's case is determined as cost effective if the amount of the premium, deductibles, coinsurance, cost sharing obligations and administrative cost are less than the Medicaid expenditures for an equivalent set of services.

TN No. 92-27

Supersedes

TN No. NEW

Approval Date 1-31-94

Eff. Date 7/1/92

II. Because Federal Financial Participation (FFP) is available for the payment of premiums for Medicaid recipients enrolled in a cost effective group health plan:

- 1 - Medicaid will pay the health insurance premiums (policyholder portion only if an employment related policy) for Medicaid recipients with policies likely to be cost effective to the Medicaid Program. Payments shall be made directly to the insurer providing the coverage, the employer or to the Medicaid recipient or guardian.
- 2 - Medicaid will pay the Medicaid allowable amount for all items and services provided the Medicaid recipient under the state plan that are not covered under the group health plan.
- 3 - Medicaid will provide for the payment of premiums when cost effective for non-Medicaid eligible family members in order to enroll a Medicaid eligible family member in the group health plan.
- 4 - Medicaid will treat the group health plan as a third party resource in accordance with North Carolina Medicaid TPL cost avoidance policies.
- 5 - The health carrier, employer, recipient or non-Medicaid eligible family member will immediately notify this agency of any event that might affect the policyholder status or the cost effectiveness of the health insurance policy.
- 6 - The North Carolina Medicaid program will receive referrals for potential candidates for the payment of premiums.

TN No. 92-27

Supersedes

TN No. NEW

Approval Date 1-31-94

Eff. Date 7/1/92

State/Territory: North Carolina

Citation

Sanctions for Psychiatric Hospitals

1902 (y) (1),  
1902(y)(2)A,  
and Section  
1902 (y)(3)  
of the Act  
(P.L. 101-508,  
Section 4755(a)(2))

(a) The State assures that the requirements of section 1902(y)(1), section 1902(y)(2)(A), and section 1902(y)(3) of the Act are met concerning sanctions for psychiatric hospitals that do not meet the requirements of participation when the hospital's deficiencies immediately jeopardize the health and safety of its patients or do not immediately jeopardize the health and safety of its patients.

1902(y)(1)(A)  
of the Act

(b) The State terminates the hospital's participation under the State plan when the State determines that the hospital does not meet the requirements for a psychiatric hospital and further finds that the hospital's deficiencies immediately jeopardize the health and safety of its patients.

1902(y)(1)(B)  
of the Act

(c) When the State determines that the hospital does not meet the requirements for a psychiatric hospital and further finds that the hospital's deficiencies do not immediately jeopardize the health and safety of its patients, the State may:

1. terminate the hospital's participation under the State plan; or
2. Provide that no payment will be made under the State plan with respect to any individual admitted to such hospital after the effective date of the finding; or
3. terminate the hospital's participation under the State plan and provide that no payment will be made under the State plan with respect to any individual admitted to such hospital after the effective date of the finding.

1902(y)(2)(A)  
of the Act

(d) When the psychiatric hospital described in (c) above has not complied with the requirements for a psychiatric hospital within 3 months after the date the hospital is found to be out of compliance with such requirements, the State shall provide that no payment will be made under the State plan with respect to any individual admitted to such hospital after the end of such 3-month period.

State: North Carolina

Citation

Sanctions for MCOs and PCCMs

1932(e)  
42 CFR 428.726

- (a) The State will monitor for violations that involve the actions and failure to act specified in 42 CFR Part 438 Subpart I and to implement the provisions in 42 CFR 438 Subpart I, in manner specified below:
- (b) The State uses the definition below of the threshold that would be met before an MCO is considered to have repeatedly committed violations of section 1903(m) and thus subject to imposition of temporary management on a case by case basis:
- (c) The State's contracts with MCOs provide that payments provided for under the contract will be denied for new enrollees when, and for so long as, payment for those enrollees is denied by CMS under 42 CFR 438.730(e).

\_\_\_\_\_ Not applicable; the State does not contract with MCOs, or the State does not choose to impose intermediate sanctions on PCCMs.



STATE PLAN UNDER TITLE XIX OF THE SOCIAL SECURITY ACT

State: North Carolina

INCOME AND ELIGIBILITY VERIFICATION SYSTEM PROCEDURES

Match With	General Description and Frequency
North Carolina Employment Security Commission (ESC)	<p>on-line inquiry available to be used at applications and redeterminations for wages reported by employers and unemployment insurance benefits.</p> <p>quarterly paper print of ESC wage information and UI benefits.</p>
Social Security Administration (SSA)	<p>on-line and monthly printout of BENDEX information for SSA benefits.</p> <p>on-line and monthly printout on SDX for SSI benefits and other income shown by SSA.</p> <p>monthly match with Beneficiary Earnings Exchange Report (BEER) to identify clients with earnings reported to SSA.</p> <p>validate SSN's of recipients with NUMIDENT file as soon as SSN is in system and if any vital data changes in system</p>
Internal Revenue Service (IRS)	<p>annual match of complete recipient file and monthly match of approved applicants to get 1099 unearned income data.</p>
North Carolina Department of Transportation (DOT)	<p>on-line inquiry of motor vehicle ownership to be used at redeterminations and applications.</p>

TN No. 87-12  
 Supersedes  
 TN No. \_\_\_\_\_

Approval Date 1/28/88

Eff. Date 10/1/87  
 HCFA ID: 0123P/0002P

Revision: HCFA-PM-87-4 (BERC)  
March 1987

Attachment 4.33-A  
Page 1  
OMB No.:0938-0193

STATE PLAN UNDER TITLE XIX OF THE SOCIAL SECURITY ACT

State/Territory: North Carolina

METHOD FOR ISSUANCE OF MEDICAID ELIGIBILITY CARDS  
TO HOMELESS INDIVIDUALS

The Medicaid identification card for an eligible individual who can give no mailing address is sent to the address of the local department of social services in the county where the individual applied. The individual is instructed at the time of his application and at each subsequent redetermination to go to the county agency on the first work day of each month to pick up his ID card for that month.

---

TN No. 87-5

Supersedes

TN No. NEW

Approval Date JUL 23 1987

Eff. Date 4/1/87

HCDA ID: 1080P/0020P

Revision: HCFA-PM-91-9 (MB)  
October 1991

Attachment 4.34-A  
Page 1  
OMB No.:

STATE PLAN UNDER TITLE XIX OF THE SOCIAL SECURITY ACT

State/Territory: North Carolina

REQUIREMENTS FOR ADVANCE DIRECTIVES UNDER STATE PLANS FOR  
MEDICAL ASSISTANCE

The following is a written description of the law of the State (whether statutory or as recognized by the courts of the State) concerning advance directives. If applicable States should include definitions of living will, durable power of attorney for health care, durable power of attorney, witness requirements, special State limitations on living will declarations, proxy designation, process information and State forms, and identify whether State law allows for a health care provider or agent of the provider to object to the implementation of advance directives on the basis of conscience.

See Supplements:

Supplement 1: North Carolina state summary of law concerning patients' rights. Pamphlet is titled "Medical Care Decisions and Advance Directives - What you Should Know."

Supplement 2: Detailed information on North Carolina's living will (Declaration of a Desire for a Natural Death), health care power of attorney and mental health advance directive (Advance Instruction for Mental Health Treatment).

State law does not explicitly allow a provider to object to implementation of advance directives on the basis of conscience.

---

TN No. 98-02  
Supersedes  
TN No. 91-50

Approval Date: 4/10/98

Effective Date: 1/1/98  
HCFA ID: 7982E

Doctor and each health care agent you named of the change. You can cancel your advance instruction for mental health treatment while you are able to make and make known your decisions, by telling your doctor or other provider that you want to cancel it.

**Whom should I talk to about an advance directive?**

You should talk to those closest to you about an advance directive and your feelings about the health care you would like to receive. Your doctor or health care provider can answer medical questions. A lawyer can answer questions about the law. Some people also discuss the decision with clergy or other trusted advisors.

**Where should I keep my advance directive?**

Keep a copy in a safe place where your family members can get it. Give copies to your family, your doctor or other health/mental health care provider, your health care agent, and any close friends who might be asked about your care should you become unable to make decisions.

**What if I have an advance directive from another state?**

An advance directive from another state may not meet all of North Carolina's rules. To be sure about this, you may want to make an advance directive in North Carolina too. Or you could have your lawyer review the advance directive from the other state.

**Where can I get more information?**

Your health care provider can tell you how to get more information about advance directives by contacting:

*This document was developed by the North Carolina Division of Medical Assistance in cooperation with the Department of Human Resources Advisory Panel on Advance Directives 1991. Revised 1999.*



**Medical Care Decisions  
and Advance Directives  
What You Should Know**

**What are My Rights?**

**Who decides about my medical care or treatment?**

If you are 18 or older and have the capacity to make and communicate health care decisions, you have the right to make decisions about your medical/mental health treatment. You should talk to your doctor or other health care provider about any treatment or procedure so that you understand what will be done and why. You have the right to say yes or no to treatments recommended by your doctor or mental health provider. If you want to control decisions about your health/mental health care even if you become unable to make or to express them yourself, you will need an "advance directive."

**What is an "advance directive"?**

An advance directive is a set of directions you give about the health/mental health care you want if you ever lose the ability to make decisions for yourself. North Carolina has three ways for you to make a formal advance directive. One way is called a "living will"; another is called a "health care power of attorney"; and another is called an "advance instruction for mental health treatment."

**Do I have to have an advance directive and what happens if I don't?**

Making a living will, a health care power of attorney or an advance instruction for mental health treatment is your choice. If you become unable to make your own decisions; and you have no living will, advance instruction for mental health treatment, or a person named to make medical/mental health decisions for you ("health care agent"), your doctor or health/mental health care provider will consult with someone close to you about your care.

Fold Here

**Living Will**

**What is a living will?**

In North Carolina, a living will is a document that tells others that you want to die a natural death if you are terminally and incurably sick or in a persistent vegetative state from which you will not recover. In a living will, you can direct your doctor not to use heroic treatments that would delay your dying, for example by using a breathing machine ("respirator" or "ventilator"), or to stop such treatments if they have been started. You can also direct your doctor not to begin or to stop giving you food and water through a tube ("artificial nutrition or hydration").

**Health Care Power of Attorney**

**What is a health care power of attorney?**

In North Carolina, you can name a person to make medical/mental health care decisions for you if you later become unable to decide yourself. This person is called your "health care agent." In the legal document you name who you want your agent to be. You can say what medical treatments/mental health treatments you would want and what you would not want. Your health care agent then knows what choices you would make.

**How should I choose a health care agent?**

You should choose an adult you trust and discuss your wishes with the person before you put them in writing.

**Advance Instruction for Mental Health Treatment**

**What is an advance instruction for mental health treatment?**

In North Carolina, an advance instruction for mental health treatment is a legal document that tells doctors and health care providers what mental health treatments you would want and what treatments you would not want, if you later become unable to decide yourself. The designation of a person to make your mental health care decisions, should you be unable to make them yourself, must be established as part of a valid Health Care Power of Attorney.

**Other Questions**

**How do I make an advance directive?**

You must follow several rules when you make a formal living will, health care power of attorney or an advance instruction for mental health treatment. These rules are to protect you and ensure that your wishes are clear to the doctor or other provider who may be asked to carry them out. A living will, a health care power of attorney and an advance instruction for mental health treatment must be written and signed by you while you are still able to understand your condition and treatment choices and to make those choices known. Two qualified people must witness all three types of advance directives. The living will and the health care power of attorney also must be notarized.

**Are there forms I can use to make an advance directive?**

Yes. There is a living will form, a health care power of attorney form and an advance instruction for mental health treatment form that you can use. These forms meet all of the rules for a formal advance directive. Using the special form is the best way to make sure that your wishes are carried out.

**When does an advance directive go into effect?**

A living will goes into effect when you are going to die soon and cannot be cured, or when you are in a persistent vegetative state. The powers granted by your health care power of attorney go into effect when your doctor states in writing that you are not able to make or to make known your health care choices. When you make a health care power of attorney, you can name the doctor or mental health provider you would want to make this decision. An advance instruction for mental health treatment goes into effect when it is given to your doctor or mental health provider. The doctor will follow the instructions you have put in the document, except in certain situations, after the doctor determines that you are not able to make and to make known your choices about mental health treatment. After a doctor determines this, your Health Care Power of Attorney may make treatment decisions for you.

**What happens if I change my mind?**

You can cancel your living will anytime by informing your doctor that you want to cancel it and destroying all the copies of it. You can change your health care power of attorney while you are able to make and make known your decisions, by signing another one and telling your

## The Living Will

A Guide for North Carolinians -- Planning Your Estate

### Introduction.

What is a living will? A living will is a declaration that you desire to die a natural death. You do not want extraordinary medical treatment or artificial nutrition or hydration used to keep you alive if there is no reasonable hope of recovery. A living will gives your doctor permission to withhold or withdraw life support systems under certain conditions.

**The patient's rights.** You have a basic right to control the decisions about your medical care, including the decision to have extraordinary means or artificial nutrition or hydration withheld or withdrawn if your condition is terminal and incurable or if you are in a persistent vegetative state.

If you are competent and able to communicate, you may tell your doctor that you do not want extraordinary means or artificial nutrition or hydration used to keep you alive if there is no reasonable hope of recovery.

What happens if you are not competent or able to communicate this decision? You may decide ahead of time with a living will. If you do not have a living will, someone else may have to decide for you.

### A living will is a legal document.

Statutory requirements. You must follow certain requirements to make your living will legally effective.

- You must be at least 18 years old and of sound mind when you sign it.
- Your living will must contain specific statements.
- You must sign your living will in the presence of two qualified witnesses and either a notary public or the clerk of superior court.

**Required statements.** To be valid in North Carolina, your living will must contain two specific statements.

1. You must declare that you do not want your doctor to use extraordinary means or artificial nutrition or hydration to keep you alive if your condition is terminal and incurable or if you are in a persistent vegetative state (depending upon your instructions).

2. You must state that you know your living will allows your doctor to withhold or stop extraordinary medical treatment or artificial nutrition or hydration (depending upon your instructions).

Beware of using a living will form provided in a magazine article or distributed by national

organizations. These forms may not contain the statements required to make them valid in North Carolina.

**Make clear, consistent choices.** You must instruct the doctor what you want done if your condition is terminal and incurable or if you are in a persistent vegetative state. You may make these choices in your living will by initialling the appropriate lines. If you make no choices, your living will is meaningless. If you make inconsistent choices, your living will is confusing and may not accomplish what you want. Read the choices carefully before initialling to make sure that your intentions are clear. An attorney can help you fill out the form correctly.

If your condition is terminal and incurable, your living will may instruct your doctor to do the following:

- to withhold or stop extraordinary means only, or
- to withhold or stop both extraordinary means and artificial nutrition or hydration.

If you are in a persistent vegetative state, your living will may instruct your doctor to do the following:

- to withhold or stop extraordinary means only, or
- to withhold or stop both extraordinary means and artificial nutrition or hydration.

**The living will must be signed, witnessed, and certified.** You must sign your living will in the presence of two witnesses:

- who are not related to you or your spouse;
- who will not inherit property from you, either under your will or under the laws that determine who will get your property if you do not have a will;
- who are not your doctor, your doctor's employees, or the employees of your hospital, nursing home or group-care home; and
- who do not have a claim against you.

Also, a notary public or a clerk or assistant clerk of superior court must certify your living will.

Statutory form. A copy of a living will, which is provided by Section 90-321, North Carolina General Statutes, is duplicated at the end of this publication. The law authorizing this form became effective Oct. 1, 1991. You should ask your attorney's advice before modifying the statutory form.

**Living wills signed under prior law.** What is the legal effect of a living will signed under prior law? A living will signed before Oct. 1, 1991, or signed using the old form is legally valid. However, the old living will does not mention being in a persistent vegetative state or the withholding or withdrawal of feeding tubes. If you want these possibilities covered, you should sign a new living will.

**How does a valid living will work?**

The living will gives your doctor permission to withhold or discontinue life support systems under two conditions. Under the first condition, you must be both terminally and incurably ill. Under the second condition, you must be diagnosed as being in a persistent vegetative state. If two doctors diagnose one of these conditions, your doctor may withhold or discontinue extraordinary medical treatment or artificial nutrition or hydration as directed by your living will.

**Definitions.**

*Artificial nutrition or hydration* describes the use of feeding tubes or other invasive means to give someone food or water.

*Extraordinary means or medical treatment* includes any medical procedure which artificially postpones the moment of death by supporting or replacing a vital bodily function.

You are considered to be in a *persistent vegetative state* if you have had a complete loss of self-aware cognition (you are a vegetable), and you will die soon without the use of extraordinary medical treatment or artificial nutrition or hydration.

**How do you revoke your living will?**

You may revoke your living will by communicating this desire to your doctor. You may use any means available to communicate your intent to revoke. Your mental or physical condition is not considered, so you do not need to be of sound mind. Someone acting on your behalf may also tell your doctor that you want to revoke your living will. Revocation is effective only after your doctor has been notified.

Destroying the original and all copies of your living will may revoke your living will as a practical matter. However, if you have discussed this issue with your doctor, be sure to tell your doctor that you have revoked your living will.

If you sign a new living will, be sure to revoke all prior living wills that may be inconsistent with your new living will.

**Where should you store your living will?**

Keep the original in a place where you or your family members may find it easily. Some lawyers suggest that you sign several copies and have each one witnessed and certified. Then, you may give an original to each of the appropriate people. However, if you change your mind and revoke your living will, make sure that you destroy all the original copies. (Note: North

Carolina law allows you to sign more than one original living will because signing a new living will does not revoke a previously signed living will.)

If you have named a health care agent, give him or her a copy of your living will. You may appoint a health care agent with a health care power of attorney or with a general durable power of attorney. Ask your lawyer for details. For more information about health care agents, read the North Carolina Cooperative Extension publication, Health Care Power of Attorney, FCS-387.

Give a copy of your living will to your doctor and any medical facility where you have regular appointments. Give a copy of your living will to your family so they understand your wishes. Also, carry a wallet card stating that you have a living will, where the original is located, and who to contact to get the original.

If you put the original of your living will in a lock box or safe deposit box, make sure someone knows where it is and has access to it. Otherwise, your living will may be found too late.

**What happens if you do not have a living will?**

If you do not have a living will and you are unable to make your medical decisions, someone else must decide for you. If two doctors diagnose that you are terminally and incurably ill or in a persistent vegetative state, extraordinary means or artificial nutrition or hydration may be withheld or stopped with the permission of:

- your guardian,
- your health care agent,
- your spouse, or  
the majority of your parents and children.

If you do not have a living will, your family is burdened with the decision. Your family may not be able to agree on what action to take. The lack of decision by your family may lengthen your suffering and increase your medical bills. A living will removes the decision from your family's shoulders and makes the decision yours.

**What is the effect of your living will if you move out of North Carolina?**

Different states have different laws on living wills, so your North Carolina living will may not be valid in another state. If you move to another state, check with an attorney there to see if you need to sign a new living will.

If you spend a lot of time in other states, you may want to sign a living will for each state. Before signing a living will from another state, ask an attorney if there is any reason why you should not sign a living will from that state. For example, you may not want to sign another state's living will if it revokes all previously signed living wills.

North Carolina Statutory Form, G.S. 90-321.

NORTH CAROLINA COUNTY OF \_\_\_\_\_

DECLARATION OF A DESIRE FOR A NATURAL DEATH

I, \_\_\_\_\_, being of sound mind, desire that, as specified below, my life not be prolonged by extraordinary means or by artificial nutrition or hydration if my condition is determined to be terminal and incurable or if I am diagnosed as being in a persistent vegetative state. I am aware and understand that this writing authorizes a physician to withhold or discontinue extraordinary means or artificial nutrition or hydration, in accordance with my specifications set forth below:

(Initial any of the following, as desired):

- \_\_\_ If my condition is determined to be terminal and incurable, I authorize the following:
  - \_\_\_ My physician may withhold or discontinue extraordinary means only.
  - \_\_\_ In addition to withholding or discontinuing extraordinary means if such means are necessary, my physician may withhold or discontinue either artificial nutrition or hydration, or both.
- \_\_\_ If my physician determines that I am in a persistent vegetative state, I authorize the following:
  - \_\_\_ My physician may withhold or discontinue extraordinary means only.
  - \_\_\_ In addition to withholding or discontinuing extraordinary means if such means are necessary, my physician may withhold or discontinue either artificial nutrition or hydration, or both.

This the \_\_\_\_\_ day of \_\_\_\_\_

Signature: \_\_\_\_\_

I hereby state that the declarant, \_\_\_\_\_, being of sound mind signed the above declaration in my presence and that I am not related to the declarant by blood or marriage and that I do not know or have a reasonable expectation that I would be entitled to any portion of the estate of the declarant under any existing will or codicil of the declarant or as an heir under the Intestate Succession Act if the declarant died on this date without a will. I also state that I am not the declarant's attending physician or an employee of the declarant's attending physician, or an employee of a health facility in which the declarant is a patient or an employee of a nursing home or any group-care home where the declarant resides. I further state that I do not now have any claim against the declarant.

Witness: \_\_\_\_\_

Witness: \_\_\_\_\_

CERTIFICATE

I, \_\_\_\_\_, Clerk (Assistant Clerk) of Superior Court or Notary Public (circle one as appropriate) for \_\_\_\_\_ County hereby certify that \_\_\_\_\_, the declarant, appeared before me and swore to me and to the witnesses in my presence that this instrument is his/her Declaration Of A Desire For A Natural Death, and that he/she had willingly and voluntarily made and executed it as his/her free act and deed for the purposes expressed in it.

I further certify that \_\_\_\_\_ and \_\_\_\_\_, witnesses, appeared before me and swore that they witnessed \_\_\_\_\_, declarant, sign the attached declaration, believing him/her to be of sound mind; and also swore that at the time they witnessed the declaration (i) they were not related within the third degree to the declarant or to the declarant's spouse, and (ii) they did not know or have a reasonable expectation that they would be entitled to any portion of the estate of the declarant upon the declarant's death under any will of the declarant or codicil thereto then existing or under the Intestate Succession Act as it provides at that time, and (iii) they were not a physician attending the declarant or an employee of an attending physician or an employee of a health facility in which the declarant was a patient or an employee of a nursing home or any group-care home in which the declarant resided, and (iv) they did not have a claim against the declarant. I further certify that I am satisfied as to the genuineness and due execution of the declaration.

This the \_\_\_\_\_ day of \_\_\_\_\_, 19\_\_\_\_.

\_\_\_\_\_  
Clerk (Assistant Clerk) of Superior Court or Notary Public (circle one as appropriate) for the County of \_\_\_\_\_

Prepared by Carol A. Schwab, J.D., LL.M., a Member of the North Carolina State Bar, and a Family Resource Management Specialist for the North Carolina Cooperative Extension Service, North Carolina State University, Raleigh, North Carolina.

The North Carolina Cooperative Extension Service prepared this publication as a public service. It is designed to acquaint you with certain legal issues and concerns. It is not designed as a substitute for



legal advice, nor does it tell you everything you may need to know about this subject. Future changes in the law cannot be predicted, and statements in this publication are based solely on the laws in force on the date of publication. If you have specific questions on this issue, seek professional advice. If you need an attorney, you may call the North Carolina Lawyer Referral Service, a non-profit public service project of the North Carolina Bar Association, toll-free: 1-800-662-7660 (Wake County residents call: 828-1054).

This publication has been issued in print by the North Carolina Cooperative Extension Service as publication FCS-364 (revised August 1993).

Published by North Carolina Cooperative Extension Service

North Carolina State University, Raleigh, North Carolina.

Distributed in furtherance of the Acts of Congress of May 8 and June 30, 1914. Employment and program opportunities are offered to all people regardless of race, color, national origin, sex, age, or disability. North Carolina State University, North Carolina A&T State University, U.S. Department of Agriculture, and local governments cooperating.

Electronic Publication FCS-364

(Posted April 1997 - CAS)

## Health Care Power of Attorney

### A Guide for North Carolinians -- Planning Your Estate

#### Introduction

You have the right to control the decisions about your medical care. To make these decisions, you must be competent and able to communicate. If you are not competent or able to communicate, someone else must make these decisions for you. A health care power of attorney allows you to choose this person. This publication explains what a health care power of attorney is and how it is used.

#### Health Care Power of Attorney

**What is it?** A health care power of attorney is a document that allows someone to make medical decisions for you if you cannot make them yourself. You must sign the document in the presence of two qualified witnesses, and it must be notarized. The form provided by Section 32A-25, North Carolina General Statutes, is duplicated at the end of this publication. Other forms may be used as long as they comply with the requirements of the statute. If you use a form, read and understand all provisions before signing. Your lawyer can explain and, if necessary, modify the available forms.

**Who may make a health care power of attorney?** You must be at least 18 years old, and you must be able to make and communicate health care decisions.

**Who may be appointed?** You may appoint any competent person who is at least 18 years old and who is not providing paid health care to you. The person you appoint is called your health care agent.

**How much authority does it give your health care agent?** You may give your health care agent the same power and authority as you have yourself to make your medical decisions. This includes the power to consent to your doctor giving, withholding or stopping any medical treatment, service or diagnostic procedure, including life-sustaining procedures.

You also may limit your health care agent's power. To make sure that your health care agent understands how you want everything handled, you may provide directions or guidelines as part of your health care power of attorney. However, limits on your health care agent's authority may reduce his or her ability to make necessary medical decisions on your behalf. Also, a too-complicated health care power of attorney may leave your doctor unsure as to which decisions may be made by your health care agent.

**When is it effective?** Your health care power of attorney is effective when a doctor states in writing that you lack sufficient understanding or capacity to make or communicate health care decisions. You may name the doctor or doctors you want to make this determination. If you do not name a doctor or if the doctors you name are unavailable, the doctor taking care of you may decide when it is effective.

#### How is a health care power of attorney revoked?

You may revoke your health care power of attorney at any time, so long as you are able to make and communicate your medical care decisions. The revocation may be in writing or by any means that you are able to communicate your intent to revoke to your doctor and health care agent. Also, you revoke a health care power of attorney by signing another health care power of attorney. Revocation is effective only after you have notified your doctor and each named health care agent. Finally, your death revokes your health care power of attorney.

#### What happens if your health care agent is unable or unwilling to act?

If your health care agent dies or becomes sick or incapacitated, or if he or she simply refuses to act, your health care power of attorney will have no legal effect. To avoid this problem, you may name one or more substitute health care agents. Your substitute health care agents will serve in the order you have listed them in your health care power of attorney.

#### How does a health care power of attorney work if you have given someone a durable power of attorney?

A durable power of attorney is a document used to give someone the legal authority to act on your behalf. A general durable power of attorney gives someone (called your "attorney-in-fact") broad powers to handle your affairs, including your property and finances. How does the health care power of attorney work if you have given someone a durable power of attorney?

You may include a health care power of attorney in your durable power of attorney. If you choose this method, the same person who has authority to handle your financial and other personal affairs will have the authority to make your health care decisions. One document covers everything.

Or, you may choose to name a health care agent in a separate health care power of attorney. A health care power of attorney does not affect the nonhealth care powers granted to your attorney-in-fact under a general durable power of attorney. However, if you give health care powers to both your attorney-in-fact and health care agent, your health care agent's power is superior.

For more information about durable powers of attorney, read the North Carolina Cooperative Extension publication, Legal Authority, FCS-363.

#### How does a health care power of attorney work if the court appoints a guardian?

If the court appoints a guardian of the person (someone to take care of your physical needs) or a general guardian (someone to take care of both you and your property), your health care power of attorney will cease to be effective. To protect your choice of health care agent, you may use your health care power of attorney to recommend that your health care agent be appointed as your

guardian of the person if you are declared legally incompetent. For more information about guardianship, read the North Carolina Cooperative Extension publication, Legal Authority, HE-363.

**Conclusion**

A health care power of attorney is the best assurance that your medical care will be handled the way you want it if you become unable to make

these decisions yourself. Simply telling your family what you want done is not enough. You need to give someone the legal right to make these decisions for you. Choose your health care agent carefully. He or she will have the right to make life and death decisions on your behalf. Make sure your health care agent understands your wishes. For guidance and more information, ask your attorney.

North Carolina Statutory Form, G.S. 32A-25

Health Care Power of Attorney

*(Notice: This document gives the person you designate your health care agent broad powers to make health care decisions for you, including the power to consent to your doctor not giving treatment or stopping treatment necessary to keep you alive. This power exists only as to those health care decisions for which you are unable to give informed consent.)*

*This form does not impose a duty on your health care agent to exercise granted powers, but when a power is exercised, your health care agent will have to use due care to act in your best interests and in accordance with this document. Because the powers granted by this document are broad and sweeping, you should discuss your wishes concerning life-sustaining procedures with your health care agent.*

*Use of this form in the creation of a health care power of attorney is lawful and is authorized pursuant to North Carolina law. However, use of this form is an optional and nonexclusive method for creating a health care power of attorney and North Carolina law does not bar the use of any other or different form of power of attorney for health care that meets the statutory requirements.)*

1. Designation of health care agent.

I, \_\_\_\_\_, being of sound mind, hereby appoint

Name: \_\_\_\_\_

Home Address: \_\_\_\_\_

Home Telephone Number \_\_\_\_\_

Work Telephone Number \_\_\_\_\_

as my health care attorney-in-fact (herein referred to as my "health care agent") to act for me and in my name (in any way I could act in person) to make health care decisions for me as authorized in this document.

If the person named as my health care agent is not reasonably available or is unable or unwilling to act as my agent, then I appoint the following persons (each to act alone and successively, in the order named), to serve in that capacity: (Optional)

A. Name: \_\_\_\_\_

Home Address: \_\_\_\_\_

Home Telephone Number \_\_\_\_\_

Work Telephone Number \_\_\_\_\_

B. Name: \_\_\_\_\_

Home Address: \_\_\_\_\_

Home Telephone Number \_\_\_\_\_

Work Telephone Number \_\_\_\_\_

Each successor health care agent designated shall be vested with the same power and duties as if originally named as my health care agent.

2. Effectiveness of appointment.

*(Notice: This health care power of attorney may be revoked by you at any time in any manner by which you are able to communicate your intent to revoke to your health care agent and your attending physician.)*

Absent revocation, the authority granted in this document shall become effective when and if the physician or physicians designated below determine that I lack sufficient understanding or capacity to make or communicate decisions relating to my health care and will continue in effect during my incapacity, until my death. This determination shall be made by the following physician or physicians (You may include here a designation of your choice, including your attending physician, or any other physician. You may also name two or more physicians, if desired, both of whom must make this determination before the authority granted to the health care agent becomes effective.):

\_\_\_\_\_  
\_\_\_\_\_  
\_\_\_\_\_

3. General statement of authority granted.

Except as indicated in section 4 below, I hereby grant to my health care agent named above full power and authority to make health care decisions on my behalf, including, but not limited to, the following:

A. To request, review, and receive any information, verbal or written, regarding my physical or mental health, including, but not limited to, medical and hospital records, and to consent to the disclosure of this information;

B. To employ or discharge my health care providers;

C. To consent to and authorize my admission to and discharge from a hospital, nursing or convalescent home, or other institution;

D. To give consent for, to withdraw consent for, or to withhold consent for, X ray, anesthesia, medication, surgery, and all other diagnostic and treatment procedures ordered by or under the authorization of a licensed physician, dentist, or podiatrist. This authorization specifically includes the power to consent to measures for relief of pain.

E. To authorize the withholding or withdrawal of life-sustaining procedures when and if my physician determines that I am terminally ill, permanently in a coma, suffer severe dementia, or am in a persistent vegetative state. Life-sustaining procedures are those forms of medical care that only serve to artificially prolong the dying process and may include mechanical ventilation, dialysis, antibiotics, artificial nutrition and hydration, and other forms of medical treatment which sustain, restore or supplant vital bodily functions. Life-sustaining procedures do not include care necessary to provide comfort or alleviate pain.

I DESIRE THAT MY LIFE NOT BE PROLONGED BY LIFE-SUSTAINING PROCEDURES IF I AM TERMINALLY ILL, PERMANENTLY IN A COMA, SUFFER SEVERE DEMENTIA, OR AM IN A PERSISTENT VEGETATIVE STATE.

F. To exercise any right I may have to make a disposition of any part or all of my body for medical purposes, to donate my organs, to authorize an autopsy, and to direct the disposition of my remains.

G. To take any lawful actions that may be necessary to carry out these decisions, including the granting of releases of liability to medical providers.

4. Special provisions and limitations.

(Notice: The above grant of power is intended to be as broad as possible so that your health care agent will have authority to make any decisions you could make to obtain or terminate any type of health care. If you wish to limit the scope of your health care agent's powers, you may do so in this section.)

In exercising the authority to make health care decisions on my behalf, the authority of my health care agent is subject to the following special provisions and limitations (Here you may include any specific limitations you deem appropriate such as: your own definition of when life-sustaining treatment should be withheld or discontinued, or instructions to refuse any specific types of treatment that are inconsistent with your religious beliefs, or unacceptable to you for any other reason.):

---

---

---

5. Guardianship provision.

If it becomes necessary for a court to appoint a guardian of my person, I nominate my health care agent acting under this document to be the guardian of my person, to serve without bond or security.

6. Reliance of third parties on health care agent.

A. No person who relies in good faith upon the authority of or any representations by my health care agent shall be liable to me, my estate, my heirs, successors, assigns, or personal representatives, for actions or omissions by my health care agent.

B. The powers conferred on my health care agent by this document may be exercised by my health care agent alone, and my health care agent's signature or act under the authority granted in this document may be accepted by persons as fully authorized by me and with the same force and effect as if I were personally present, competent, and acting on my own behalf. All acts performed in good faith by my health care agent pursuant to this power of attorney are done with my consent and shall have the same validity and effect as if I were present and exercised the powers myself, and shall inure to the benefit of and bind me, my estate, my heirs, successors, assigns, and personal representatives. The authority of my health care agent

pursuant to this power of attorney shall be superior to and binding upon my family, relatives, friends, and others.

7. Miscellaneous provisions.

A. I revoke any prior health care power of attorney.

B. My health care agent shall be entitled to sign, execute, deliver, and acknowledge any contract or other document that may be necessary, desirable, convenient, or proper in order to exercise and carry out any of the powers described in this document and to incur reasonable costs on my behalf incident to the exercise of these powers; provided, however, that except as shall be necessary in order to exercise the powers described in this document relating to my health care, my health care agent shall not have any authority over my property or financial affairs.

C. My health care agent and my health care agent's estate, heirs, successors, and assigns are hereby released and forever discharged by me, my estate, my heirs, successors, and assigns and personal representatives from all liability and from all claims or demands of all kinds arising out of the acts or omissions of my health care agent pursuant to this document, except for willful misconduct or gross negligence.

D. No act or omission of my health care agent, or of any other person, institution, or facility acting in good faith in reliance on the authority of my health care agent pursuant to this health care power of attorney shall be considered suicide, nor the cause of my death for any civil or criminal purposes, nor shall it be considered unprofessional conduct or as lack of professional competence. Any person, institution, or facility against whom criminal or civil liability is asserted because of conduct authorized by this health care power of attorney may interpose this document as a defense.

8. Signature of principal.

By signing here, I indicate that I am mentally alert and competent, fully informed as to the contents of this document, and understand the full import of this grant of powers to my health care agent.

\_\_\_\_\_ Date \_\_\_\_\_

Signature of Principal '(SEAL)'

9. Signatures of Witnesses.

I hereby state that the Principal, \_\_\_\_\_, being of sound mind, signed the foregoing health care power of attorney in my presence, and that I am not related to the principal by blood or marriage, and I would not be entitled to any portion of the estate of the principal under any existing will or codicil of the principal or as an heir under the Intestate Succession Act, if the principal died on this date without a will. I also state that I am not the principal's attending physician, nor an employee of the principal's attending physician, nor an employee of the health facility in which the principal is a patient, nor an employee of a nursing home or any group care home where the principal resides. I further state that I do not have any claim against the principal.

Witness: \_\_\_\_\_ Date: \_\_\_\_\_

Witness: \_\_\_\_\_ Date: \_\_\_\_\_

STATE OF NORTH CAROLINA

COUNTY OF \_\_\_\_\_

CERTIFICATE

I, \_\_\_\_\_, a Notary Public for \_\_\_\_\_ County, North Carolina, hereby certify that \_\_\_\_\_ appeared before me and swore to me and to the witnesses in my presence that his instrument is a health care power of attorney, and that he/she willingly and voluntarily made and executed it as his/her free act and deed for the purposes expressed in it.

I further certify that \_\_\_\_\_ and \_\_\_\_\_, witnesses, appeared before me and swore that they witnessed \_\_\_\_\_ sign the attached health care power of attorney, believing him/her to be of sound mind; and also swore that at the time they witnessed the signing (i) they were not related within the third degree to him/her or his/her spouse, and (ii) they did not know nor have a reasonable expectation that they would be entitled to any portion of his/her estate upon his/her death under any will or codicil thereto then existing or under the Intestate Succession Act as it provided at that time, and (iii) they were not a physician attending him/her, nor an employee of an attending physician, nor an employee of a health facility in which he/she was a patient, nor an employee of a nursing home or any group-care home in which he/she resided, and (iv) they did not have a claim against him/her. I further certify that I am satisfied as to the genuineness and due execution of the instrument.

This the \_\_\_\_\_ day of \_\_\_\_\_, 19\_\_\_\_.

\_\_\_\_\_  
Notary Public

My Commission Expires:

(A copy of this form should be given to your health care agent and any alternate named in this power of attorney and to your physician and family members.)

Prepared by Carol A. Schwab, J.D., LL.M., a Member of the North Carolina State Bar, and a Family Resource Management Specialist for the North Carolina Cooperative Extension Service, North Carolina State University, Raleigh, North Carolina.

The North Carolina Cooperative Extension Service prepared this publication as a public service. It is designed to acquaint you with certain legal issues and concerns. It is not designed as a substitute for legal advice, nor does it tell you everything you may need to know about this subject. Future changes in the law cannot be predicted, and statements in this publication are based solely on the laws in force on the date of publication. If you have specific questions on this issue, seek professional advice. If you need an attorney, you may call the North Carolina Lawyer Referral Service, a non-profit public service project of the North Carolina Bar Association, toll-free: 1-800-662-7660 (Wake County residents call: 828-1054).

This publication has been issued in print by the North Carolina Cooperative Extension Service as publication FCS-387 (revised August 1993).

Published by North Carolina Cooperative Extension Service

North Carolina State University, Raleigh, North Carolina

Distributed in furtherance of the Acts of Congress of May 8 and June 30, 1914. Employment and program opportunities are offered to all people regardless of race, color, national origin, sex, age, or disability. North Carolina State University, North Carolina A&T State University, U.S. Department of Agriculture, and local governments cooperating.

Electronic Publication FCS-387

(Posted April 1997 - CAS)

**Advance Instruction for  
Mental Health Treatment**

**A Guide for North Carolinians**

Note: In 1998 the North Carolina General Assembly substantially modified this legislation. Consequently, the following publication is of historical interest only! A new publication is forthcoming.

**Introduction**

You have the right to control the decisions about your medical care. To make these decisions, you must be competent and able to communicate. If you are not competent or able to communicate, someone else must make these decisions for you. Advance instructions allow you to have some control in this situation.

In North Carolina, you may have a general health care power of attorney that covers all health care problems. If you wish, you may also have an advance instruction that covers only mental health care. This publication explains an advance instruction for mental health treatment. For more information on a general health care power of attorney, see the North Carolina Cooperative Extension Service publication, Health Care Power of Attorney, FCS-387.

**What is an advance instruction on mental health treatment?**

An advance instruction on mental health treatment allows you to give instructions and preferences regarding mental health treatment. It also allows you to appoint an agent to make these decisions for you when you are incapable of making them yourself. You must sign the document in the presence of two qualified witnesses. The form provided by §122C-77 of the North Carolina General Statutes is duplicated in this publication. Other forms may be used as long as they comply with the requirements of the statute. If you use a form, read and understand all provisions before signing. Your lawyer can explain and, if necessary, modify the available forms.

**Who may make an advance instruction for mental health?**

Any person of sound mind who is age 18 or over may make an advance instruction regarding mental health treatment. This person is called the "principal."

**When is it effective?**

An advance instruction becomes effective when it is delivered to your doctor or other mental health treatment provider. It remains valid until revoked or expired. It automatically expires in two years. If the principal is capable, he or she may revoke the advance instruction at any time in whole or in part. The revocation is effective when the principal notifies his or her doctor or other provider that it is revoked.

**What is the doctor's duty?**

The doctor must make the advance instruction part of the patient's medical record. The doctor must comply with it to the fullest extent possible, unless compliance is not consistent with

- Best medical practice to benefit the principal,
- Availability of the mental health treatments requested, and
- Applicable law.

If the doctor is unwilling to comply with part or all of the advance instruction for one or more of the reasons stated above, he or she must notify the principal or agent and must record the reason in the patient's medical record.

A doctor need not honor the advance instruction in cases of emergencies or involuntarily committed patients.

**How is an agent appointed?**

An advance instruction may name a competent adult to act as an agent to make decisions about mental health treatment. An alternate agent may also be named to act as agent if the first choice is unable or unwilling to act. An agent must accept the appointment in writing.

The following people may not serve as the agent:

- The principal's doctor or mental health service provider or an employee of the doctor or provider, if unrelated to the principal by blood, marriage, or adoption.
- An owner, operator, or employee of a health care facility, if unrelated to the principal by blood, marriage, or adoption.



**What is the agent's authority?**

The agent may make decisions about mental health treatment on behalf of the principal only when the principal is incapable. The principal is incapable when the doctor or psychologist determines that the principal currently lacks the capacity to make and communicate mental health treatment decisions.

The decisions of the agent must be consistent with the desires the principal has stated in the advance instruction. If the principal's desires are not stated in the advance instruction, the agent must act in good faith in the manner in which the agent believes the principal would act if he or she were capable.

**What are the agent's rights?**

The agent has the same rights as the principal to receive information about the proposed mental health treatment, and to receive, review, and consent to disclosure of medical records relating to that treatment.

The agent may withdraw as agent by giving notice to the principal. If the principal is incapable, the agent may withdraw by giving notice to the doctor or other provider. Notice of withdrawal may be oral, but it is preferable to put it in writing. The doctor or provider must note the agent's withdrawal in the principal's medical record.

**What is the agent's potential liability?**

The agent is not personally liable, as a result of acting as an agent, for the cost of treatment provided to the principal. The agent is not subject to criminal prosecution, civil liability, or professional disciplinary action for any action taken in good faith pursuant to an advance instruction.

**Who may witness it?**

An advance instruction for mental health treatment must be witnessed by two people who personally know the principal. Neither may be

- A person appointed as the agent;
- The principal's doctor or mental health service provider or a relative of the doctor or provider;
- The owner, operator, or relative of an owner or operator of a facility in which the principal is a patient or resident; or
- A person related to the principal by blood, marriage, or adoption.

**Conclusion**

The advance instruction for mental health treatment became effective in North Carolina on January 1, 1998. Ask your attorney for more information.

Author's note: The legislation creating the advance instruction for mental health treatment is the subject of much criticism and discussion. Efforts are currently being made to amend this legislation. For more information, read Schwab, Carol. "A Critical Analysis of North Carolina's Advance Instruction for Mental Health Treatment." The Forum for Family and Consumer Issues 3.1 (1998): 39 pars. 7 March 1998 <<http://www.ces.ncsu.edu/depts/fcs/pub/1998/aimht.html>>.

**Prepared by Carol A. Schwab, J.D., LL.M., a Member of the North Carolina State Bar and a Family Resource Management Specialist for the North Carolina Cooperative Extension Service, North Carolina State University, Raleigh, North Carolina.**

The North Carolina Cooperative Extension Service prepared this publication as a public service. It is designed to acquaint you with certain legal issues and concerns. It is not designed as a substitute for legal advice, nor does it tell you everything you may need to know about this subject. Future changes in the law cannot be predicted, and statements in this publication are based solely on the laws in force on the date of publication. If you have specific questions on this issue, seek professional advice. If you need an attorney, you may call the North Carolina Lawyer Referral Service, a non-profit public service project of the North Carolina Bar Association, toll-free: 1-800-662-7660 (Wake County residents call: 828-1054).

This publication has been issued in print by the North Carolina Cooperative Extension Service as publication FCS-484 (February 1998).

**Published by North Carolina Cooperative Extension Service.**

North Carolina State University, Raleigh, North Carolina.

Distributed in furtherance of the Acts of Congress of May 8 and June 30, 1914. Employment and program opportunities are offered to all people regardless of race, color, national origin, sex, age, or

disability. North Carolina State University, North Carolina A&T State University, U.S. Department of Agriculture, and local governments cooperating.

Electronic Publication FCS-484.

(February 1998 - CAS)

**ADVANCE INSTRUCTION FOR MENTAL HEALTH TREATMENT**

I, \_\_\_\_\_, being an adult of sound mind, willfully and voluntarily make this advance instruction for mental health treatment to be followed if it is determined by a physician or eligible psychologist that my ability to receive and evaluate information effectively or communicate decisions is impaired to such an extent that I lack the capacity to refuse or consent to mental health treatment. 'Mental health treatment' means the process of providing for the physical, emotional, psychological, and social needs of the principal. 'Mental health treatment' includes electroconvulsive treatment (ECT), commonly referred to as 'shock treatment,' treatment of mental illness with psychotropic medication, and admission to and retention in a facility for care or treatment of mental illness.

I understand that psychoactive medications and electroconvulsive treatment (ECT) (commonly referred to as 'shock treatment') may not be administered without my express and informed written consent or, if I am incapable of giving my informed consent, the express and informed written consent of my legally responsible person, health care agent named pursuant to a valid health care power of attorney, or attorney-in-fact named pursuant to a valid advance instruction for mental health treatment, as required under G.S. 122C-57.

I understand that I may become incapable of giving or withholding informed consent for mental health treatment due to the symptoms of a diagnosed mental disorder. These symptoms may include: \_\_\_\_\_  
\_\_\_\_\_

**PSYCHOACTIVE MEDICATIONS**

If I become incapable of giving or withholding informed consent for mental health treatment, my instructions regarding psychoactive medications are as follows:

I consent to the administration of the following medications: \_\_\_\_\_  
\_\_\_\_\_

I do not consent to the administration of the following medications: \_\_\_\_\_  
\_\_\_\_\_

Conditions or limitations: \_\_\_\_\_  
\_\_\_\_\_

**ADMISSION TO AND RETENTION IN FACILITY**

If I become incapable of giving or withholding informed consent for mental health treatment, my instructions regarding admission to and retention in a health care facility for mental health treatment are as follows:

\_\_\_\_\_ I consent to being admitted to a health care facility for mental health treatment.

My facility preference is \_\_\_\_\_

\_\_\_\_\_ I do not consent to being admitted to a health care facility for mental health treatment.

This advance instruction cannot, by law, provide consent to retain me in a facility for more than 10 days.

Conditions or limitations: \_\_\_\_\_  
\_\_\_\_\_

**ADDITIONAL INSTRUCTIONS**

These instructions shall apply during the entire length of my incapacity.

In case of mental health crisis, please contact:

1. Name: \_\_\_\_\_

Home Address: \_\_\_\_\_

Home Telephone Number: \_\_\_\_\_

Work Telephone Number: \_\_\_\_\_

Relationship to Me: \_\_\_\_\_

2. Name: \_\_\_\_\_

Home Address: \_\_\_\_\_

Home Telephone Number: \_\_\_\_\_

Work Telephone Number: \_\_\_\_\_

Relationship to Me: \_\_\_\_\_

3. My Physician: \_\_\_\_\_

Name: \_\_\_\_\_

Telephone Number: \_\_\_\_\_

4. My Therapist: \_\_\_\_\_

Name: \_\_\_\_\_

Telephone Number: \_\_\_\_\_

The following may cause me to experience a mental health crisis: \_\_\_\_\_

\_\_\_\_\_

The following may help me avoid a hospitalization: \_\_\_\_\_

\_\_\_\_\_

I generally react to being hospitalized as follows: \_\_\_\_\_

\_\_\_\_\_

Staff of the hospital or crisis unit can help me by doing the following: \_\_\_\_\_

\_\_\_\_\_

I give permission for the following person or people to visit me: \_\_\_\_\_

\_\_\_\_\_

Instructions concerning any other medical interventions, such as electroconvulsive (ECT) treatment (commonly referred to as 'shock treatment'): \_\_\_\_\_

\_\_\_\_\_

Other instructions: \_\_\_\_\_

\_\_\_\_\_

I have attached an additional sheet of instructions to be followed and considered part of this advance instruction.

**ATTORNEY-IN-FACT**

I hereby appoint:

Name: \_\_\_\_\_

Home Address: \_\_\_\_\_

Home Telephone Number: \_\_\_\_\_

Work Telephone Number: \_\_\_\_\_

to act as my attorney-in-fact to make decisions regarding my mental health treatment if I become incapable of giving or withholding informed consent for that treatment.

If the person named above refuses or is unable to act on my behalf, or if I revoke that person's authority to act as my attorney-in-fact, I authorize the following person to act as my attorney-in-fact:

Name: \_\_\_\_\_

Home Address: \_\_\_\_\_

Home Telephone Number: \_\_\_\_\_

Work Telephone Number: \_\_\_\_\_

My attorney-in-fact is authorized to make decisions that are consistent with the instructions I have expressed in this advance instruction or, if not expressed, as are otherwise known by my attorney-in-fact, my attorney-in-fact is to act in what he or she believes to be my best interests.

If it becomes necessary for the court to appoint a guardian for me, I hereby nominate my attorney-in-fact to serve in that capacity.

By signing here, I indicate that I am mentally alert and competent, fully informed as to the contents of this document, and understand the full import of this grant of powers to my attorney-in-fact.

Signature of Principal \_\_\_\_\_ Date \_\_\_\_\_

**AFFIRMATION OF WITNESSES**

We affirm that the principal is personally known to us, that the principal signed or acknowledged the principal's signature on this advance instruction for mental health treatment in our presence, that the principal appears to be of sound mind and not under duress, fraud, or undue influence, and that neither of us is: (1) A person appointed as an attorney-in-fact by this document; (2) The principal's attending physician or mental health service provider or a relative of the physician or provider; (3) The owner, operator, or relative of an owner or operator of a facility in which the principal is a patient or resident; or (4) A person related to the principal by blood, marriage, or adoption.

Witnessed by:

Witness: \_\_\_\_\_ Date: \_\_\_\_\_

Witness: \_\_\_\_\_ Date: \_\_\_\_\_

STATE OF NORTH CAROLINA

COUNTY OF \_\_\_\_\_

**ACCEPTANCE OF APPOINTMENT AS ATTORNEY-IN-FACT**

I accept this appointment and agree to serve as attorney-in-fact to make decisions about mental health treatment for the principal. I understand that I have a duty to act consistent with the desires of the principal as expressed in this appointment. I understand that this document gives me authority to make decisions about mental health treatment only while the principal is incapable as determined by a qualified, crisis, services professional and a physician or eligible psychologist. I understand that the principal may revoke this advance instruction in whole or in part at any time and in any manner when the principal is not incapable.

Signature of Attorney-in-fact \_\_\_\_\_ Date \_\_\_\_\_

Signature of Alternative Attorney-in-fact \_\_\_\_\_ Date \_\_\_\_\_

Revision: HCFA-PM-95-4 (HSQB)  
June 1995

Attachment 4.35-A

STATE PLAN UNDER TITLE XIX OF THE SOCIAL SECURITY ACT

State/Territory: North Carolina

ELIGIBILITY CONDITIONS AND REQUIREMENTS

---

Enforcement of Compliance for Nursing Facilities

---

The State uses other factors described below to determine the seriousness of deficiencies in addition to those described at §488.404(b)(1):

---

TN No. 95-12

Supersedes

Approval Date 10-23-95

Effective Date: 7/1/95

TN No. \_\_\_\_\_

Revision: HCFA-PM-95-4  
June 1995

(HSQB)

Attachment 4.35-B

STATE PLAN UNDER TITLE XIX OF THE SOCIAL SECURITY ACT

State/Territory: North Carolina

ELIGIBILITY CONDITIONS AND REQUIREMENTS

---

Enforcement of Compliance for Nursing Facilities

---

Termination of Provider Agreement: Describe the criteria (as required at §1919(h)(2)(A) for applying the remedy.

X Specified Remedy

(Will use the criteria and notice requirements specified in the regulation.)

---

TN No. 95-12  
Supersedes  
TN No. 90-12

Approval Date: 10-23-95

Effective Date: 7/1/95

Revision: HCFA-PM-95-4 (HSQB)  
June 1995

Attachment 4.35-C

STATE PLAN UNDER TITLE XIX OF THE SOCIAL SECURITY ACT

State/Territory: North Carolina

ELIGIBILITY CONDITIONS AND REQUIREMENTS

---

Enforcement of Compliance for Nursing Facilities

---

Temporary Management: Describe the criteria (as required at §1919(h)(2)(A) for applying the remedy.

Specified Remedy

(Will use the criteria and notice requirements specified in the regulation.)

Alternative Remedy

(Describe the criteria and demonstrate that the alternative remedy is as effective in deterring non-compliance. Notice requirements are as specified in the regulations.)

---

TN No. 95-12  
Supersedes  
TN No. 90-12

Approval Date: 10-23-95

Effective Date: 7/1/95

Revision: HCFA-PM-95-4 (HSQB)  
June 1995

Attachment 4.35-D

STATE PLAN UNDER TITLE XIX OF THE SOCIAL SECURITY ACT

State/Territory: North Carolina

ELIGIBILITY CONDITIONS AND REQUIREMENTS

---

Enforcement of Compliance for Nursing Facilities

---

Denial of Payment for New Admissions: Describe the criteria (as required at §1919(h)(2)(A) for applying the remedy.

Specified Remedy

(Will use the criteria and notice requirements specified in the regulation.)

Alternative Remedy

(Describe the criteria and demonstrate that the alternative remedy is as effective in deterring non-compliance. Notice requirements are as specified in the regulations.)

---

TN No. 95-12  
Supersedes  
TN No. 90-12

Approval Date: 10-23-95

Effective Date: 7/1/95



Revision: HCFA-PM-95-4 (HSQB)  
June 1995

Attachment 4.35-E

STATE PLAN UNDER TITLE XIX OF THE SOCIAL SECURITY ACT

State/Territory: North Carolina

ELIGIBILITY CONDITIONS AND REQUIREMENTS

---

Enforcement of Compliance for Nursing Facilities

---

Civil Money Penalty: Describe the criteria (as required at §1919(h)(2)(A) for applying the remedy.

Specified Remedy

(Will use the criteria and notice requirements specified in the regulation.)

Alternative Remedy

(Describe the criteria and demonstrate that the alternative remedy is as effective in deterring non-compliance. Notice requirements are as specified in the regulations.)

---

TN No. 95-12  
Supersedes  
TN No. 90-12

Approval Date: 10-23-95

Effective Date: 7/1/95

Revision: HCFA-PM-95-4 (HSQB)  
June 1995

Attachment 4.35-F

STATE PLAN UNDER TITLE XIX OF THE SOCIAL SECURITY ACT

State/Territory: North Carolina

ELIGIBILITY CONDITIONS AND REQUIREMENTS

---

Enforcement of Compliance for Nursing Facilities

---

State Monitoring: Describe the criteria (as required at §1919(h)(2)(A) for applying the remedy.

Specified Remedy

(Will use the criteria and notice requirements specified in the regulation.)

Alternative Remedy

(Describe the criteria and demonstrate that the alternative remedy is as effective in deterring non-compliance. Notice requirements are as specified in the regulations.)

---

TN No. 95-12  
Supersedes  
TN No. 90-12

Approval Date: 10-23-95

Effective Date: 7/1/95

Revision: HCFA-PM-95-4 (HSQB)  
June 1995

Attachment 4.35-G

STATE PLAN UNDER TITLE XIX OF THE SOCIAL SECURITY ACT

State/Territory: North Carolina

ELIGIBILITY CONDITIONS AND REQUIREMENTS

---

Enforcement of Compliance for Nursing Facilities

---

Transfer of residents; Transfer of residents with closure of facility: Describe the criteria (as required at §1919(h)(2)(A) for applying the remedy.

X Specified Remedy

(Will use the criteria and notice requirements specified in the regulation.)

         Alternative Remedy

(Describe the criteria and demonstrate that the alternative remedy is as effective in deterring non-compliance. Notice requirements are as specified in the regulations.)

---

TN No. 95-12  
Supersedes  
TN No. 90-12

Approval Date: 10-23-95

Effective Date: 7/1/95

Revision: HCFA-PM-95-4 (HSQB)  
June 1995

Attachment 4.35-H

STATE PLAN UNDER TITLE XIX OF THE SOCIAL SECURITY ACT

State/Territory: North Carolina

ELIGIBILITY CONDITIONS AND REQUIREMENTS

---

Enforcement of Compliance for Nursing Facilities

---

Additional Remedies: Describe the criteria (as required at §1919(h)(2)(A) for applying the remedy. Include the enforcement category in which the remedy will be imposed (i.e., category 1, category 2, or category 3 as described at 42 CFR 488.408).

Directed Plan of Correction

The directed plan of correction will be used as an available remedy as described in CFR 488.406(a)(6) Available Remedies. Category and application of the remedy will be the same as described in CFR 488.408 Selection of Remedies.

Directed In-Service Training

The directed in-service training will be used as an available remedy as described in CFR 488.406(a)(7) Available Remedies. Category and application of the remedy will be the same as described in CFR 488.408 Selection of Remedies.

Suspension of All Admissions

Suspension of all admissions remedy will be applied in situations where there is widespread or pattern deficiencies in facilities where the causes of the deficiencies are linked to system failures. Criteria for application of the remedy will be defined as a category 2 and will be applied in the same manner as described for category 2 remedies in CFR 488.408.

The additional remedy is requested to protect private pay residents from being admitted to facilities in Medicare/Medicaid beds which time a remedy for denial of payment for new admissions (Medicare/Medicaid) would otherwise be deemed appropriate.

---

TN No. 95-12  
Supersedes  
TN No. 90-12

Approval Date: 10-23-95

Effective Date: 7/1/95

Revision: HCFA-PM-91-10 (BPD)

Attachment 4.38

Page 1

STATE PLAN UNDER TITLE XIX OF THE SOCIAL SECURITY ACT

State/Territory: North Carolina

DISCLOSURE OF ADDITIONAL REGISTRY INFORMATION

Findings of Abuse, Neglect, Misappropriation

Nurse Aide Level I or II:

Listing Number:

Full Name:

Address:

Social Security Number:

Date of Birth:

Training Program Number:

Date of Competency Test:

Date Listing Expires:

Last Place Worked:

Date Last Employed:

Employment Setting:

Competency Test Number:

Remain on Registry:                   yes or no

---

TN No. 92-08

Supersedes

TN No. NEW

Approval Date: MAR 27 1992

Effective Date: 1/1/92

HCFA ID:

Revision: HCFA-PM-91-10 (BPD)

Attachment 4.38A  
Page 1

STATE PLAN UNDER TITLE XIX OF THE SOCIAL SECURITY ACT

State/Territory: North Carolina

COLLECTION OF ADDITIONAL REGISTRY INFORMATION

Information in Data Base for Abuse Registry

Incident Date:

Date Charged:

Status of Investigation:

Incident location:

Nature of allegation:

Brief description of evidence:

Hearing Date:

Result of Hearing:

Nurse Aide Rebuttal:

---

TN No. 92-08

Supersedes

Approval Date: MAR 27 1992

Effective Date: 1/1/92

TN No. NEW

HCFA ID:

STATE PLAN UNDER TITLE XIX OF THE SOCIAL SECURITY ACT

State/Territory: North Carolina

DEFINITION OF SPECIALIZED SERVICES

The Division of Medical Assistance (DMA) shall define specialized services for the purposes of Preadmission Screening and Annual Resident Review as follows:

A. Mental Illness

1. Individual psychotherapy
2. Group psychotherapy
3. Psychiatric Evaluation
4. Psychiatric Testing
5. Inpatient Psychiatric Care

B. Mental Retardation and Related Conditions

Habilitation services including behavior change intervention, requiring consultation and monitoring by a licensed psychiatrist or psychologist on a regular basis, communication skills training, counseling and training in self-help and community living skills.

The Division of Mental Health, Developmental Disabilities and Substance Abuse Services (DMH/DD/SAS) shall be responsible for ensuring the provision of specialized services.

STATE PLAN UNDER TITLE XIX OF THE SOCIAL SECURITY ACT

State/Territory: North Carolina

CATEGORICAL DETERMINATIONS

Categorical determinations are advance group determinations that clearly indicate nursing facility services are needed due to certain diagnoses, level of severity of illness, or need for a particular service. Categorical determinations do not exempt an individual from PASARR. Individuals falling into one of these seven categories may require further evaluation either through a Level II or an Annual Resident Review. North Carolina has seven instances where categorical determinations can be applied.

Emergency: Refers to immediate need for placement as a protective service measure. This standard applies if:

- a. based on the MI/MR individual's physical and/or environmental status, there is a sudden and unexpected need for immediate NF placement; and
- b. the above need requires temporary placement up to 7 days until alternative services/placement can be secured and no other placement options are available.

Delirium: A condition whereby the presence of delirious state precluded the ability of the referral source to determine Level I measures and there is a subsequent need to allow the delirium to clear before proceeding with that screen. Up to seven (7) days of NF care is allowed pending further assessment. Delirium is an acute organic mental syndrome. It is a medical emergency that demands identifications of the cause as rapidly as possible. Delirium is a categorical determination that nursing facility care is needed, however, only up to seven days is allowed before further screening must be done.

Respite Care: For In-Home Caregivers of Individuals with MR or MI - Up to seven (7) consecutive days of NF care is allowed. Individuals with MR/DD or MI who need short-term placement can be admitted for up to 7 days to give the caregiver temporary relief.

---

TN No. 94-30

Supersedes

Approval Date: NOV 30 1994

Effective Date: 7/1/94

TN No. \_\_\_\_\_



STATE PLAN UNDER TITLE XIX OF THE SOCIAL SECURITY ACT

State/Territory: North Carolina

CATEGORICAL DETERMINATIONS

Dementia/MR: The individual has a primary diagnosis of dementia existing in combination with mental retardation or related condition. In conjunction with having been diagnosed with mental retardation, the individual is also diagnosed with dementia suffering further loss of cognitive and intellectual functions which are severe and interfere with functioning ability. The essential deficit is loss of memory, both short and long-term. Abstract thinking and judgments are further impaired. Specialized services can be waived.

Terminal Illness: The individual has a medical prognosis that his/her life expectancy is six months or less. An individual with mental illness or mental retardation who is not a danger to self or others and has a medical prognosis that his/her life expectancy is six months or less may be admitted to a nursing facility. The need for specialized services must be based on an individualized evaluation.

Convalescent Care in excess of 30 days, but not to exceed 60 days: The individual requires convalescent care from an acute physical illness following hospitalization. Individuals in the category are not exempt from PASARR. An individual with mental illness or mental retardation who is not a danger to self or others may be admitted to a nursing facility for care in excess of 30 days, but not to exceed 60 days for convalescent care as a result of and acute physical illness following a hospitalization. The need for specialized services must be based on an individualized evaluation.

Severe Medical Condition: The individual with MI or MR may not be expected to benefit from specialized services due to the level of impairment of a severe medical condition such as amyotrophic lateral sclerosis, Huntington's disease, coma, ventilator dependent, congestive heart failure, obstructive pulmonary disease, Parkinson's disease, advanced multiple sclerosis, muscular dystrophy, cerebellar degeneration, cardiovascular accident, end state renal disease, severe diabetic neuropathies, quadriplegia, refractory anemias. The need for specialized services must be based on an individualized evaluation depending on the severity of the illness. Further evaluation is not necessary for individuals experiencing coma or in a persistent vegetative state.

---

TN No. 94-30

Supersedes

Approval Date: NOV 30 1994

Effective Date: 7/1/94

TN No. \_\_\_\_\_

\*U.S. G.P.O.: 1993-342-239:80013

STATE PLAN UNDER TITLE XIX OF THE SOCIAL SECURITY ACT

State/Territory: North Carolina

ELIGIBILITY CONDITIONS AND REQUIREMENTS

---

Survey and Certification Education Program

---

The State has in effect the following survey and certification periodic educational program for the staff and residents (and their representatives) of nursing facilities in order to present current regulations, procedures, and policies.

Attached you will find the listing of Educational offerings for providers and/or the community beginning August 1990. This list is maintained ongoing. Lesson plans and attendance rosters are on file in the Certification Section, Division of Facility Services.

The Training Branch of the Certification Section will continue to entertain all requests for training from the provider and consumer community.

In addition, the Training Coordinator is available by telephone five days per week for technical assistance with OBRA regulation. This service will continue ongoing.

Community College based training is planned for Educational offerings on Nurse Aide Registry. This will be developed and conducted by the staff of the Nurse Aide Registry, located at the Division of Facility Services.

In addition to Provider Training listed, the Division of Facility Services has three standing committees with the provider community which provide for regulatory clarification. These three committees are:

1. Regulatory Focus Committee - Committee of Long Term Care Association members, providers, and staff of the Division who meet monthly to address regulatory concerns and send out a newsletter to all providers.
2. Home Health Liaison Committee - Composed of providers and Association members from the home health industry that meets quarterly to address regulatory concerns. Newsletter is sent out quarterly.
3. ICF/MR Review Committee - Composed of Association members, institutional and community providers, and state representatives. Meets once a quarter to clarify issues related to ICF/MR. A newsletter is sent to all providers.

The Division also provides staff at winter and summer meetings of the North Carolina Health Care Facilities Association Convention to serve on panels, give presentations and participate in workshops.

Survey and Certification Education Program

A staff person is provided to teach a session of the class for Nursing Home Administration being licensed in North Carolina on an ongoing basis.

Staff of the Division make themselves available to the long term care industry on an ongoing basis to provide training when new requirements come down. For example, we have volunteered to provide statewide training on changes in OBRA.

Staff of the Division are available for long term care seminars when requested to serve on panels or make presentations. For example, on May 7<sup>th</sup> of this year the Certification Chief served on a panel of a Division of Aging session in Greensboro.

Staff with the Division of Medical Assistance have provided training in the area of advanced directives.

The Nurse Aide program has also provided training to providers.  
(See attached)

We have requested an additional staff development position in this coming years' budget to provide additional training to providers and residents. We will take requests from the provider community for local training at facilities, provide staff for training at corporate and association meetings when requested, provided ongoing training in Raleigh and Black Mountain for providers and provide staff for other training as time allows.

---

TN No. 92-25  
Supersedes  
TN No. NEW

Approval Date: AUG 27 1992 Effective Date: 4/1/92

PROVIDER TRAINING - AUGUST 1990 THRU NOVEMBER, 1991

8/15/90	North Carolina Health Care Facilities Association Mid Year Meeting
9/11- 13/90	North Carolina Health Care Facilities Association Coping with OBRA
9/19/90	Western Round-up - Dietetics
9/20/90	N.C. Chapter of the American Colleges of Health Care Administrators - "OBRA Are We Ready"
10/12/90	Legal Issues in Long Term Care Health - Raleigh
10/19/90	Legal Issues in Long Term Care Health - Hickory
12/5/90	N.C. Hospital Association "Insights on the Long Term Care Provisions of OBRA"
2/3/91	Third Annual Post Graduate Workshop for Consultant Pharmacists
2/18/91	General Regulatory Seminar, North Carolina Health Care Facilities Association
3/5- 7/91	Provider Training for Resident Assessment Instrument
3/13- 14/91	Provider Training for Resident Assessment Instrument
3/19/91	Provider Training for Resident Assessment Instrument
3/21/91	Provider Training for Resident Assessment Instrument
3/26/91	Provider Training for Resident Assessment Instrument
4/10/91	N.C. Dietary Managers Association
4/11/91	N.C. Nurse's Association Gerontology Council - Overview of the Resident Assessment Instrument
5/9/91	Buncombe Co. Nursing Home Advisory Committee - OBRA Regulations
5/24/91	University of North Carolina Asheville - Tenth Annual Western N.C. Gerontology Forum: Quality of Life and Resident Rights in Long Term Care: The Impact of OBRA
8/22/91	Wilmington Area AHEC: Resident Rights and Quality of Life: A Social Worker's Perspective
10/22-24/91	N.C. Division of Aging: Aging and Health: The Community Connection: RAI
10/23/91	Implementing the Patient Self-Determination Act - Asheville, N.C.

TN No. 92-25  
Supersedes  
TN No. New

Approval Date AUG 27 1992

Effective Date 4/1/92

PROVIDER TRAINING APRIL 1991 - MARCH, 1992

10/28/91	Constituency Meeting - N.C. Hosp. Association: LTC Short Term Beds - MDS
11/11/91	Implementing the Patient Self-Determination Act - Fayetteville, N.C.
3/26/92	"On the Road to Excellence" Bristlecone Consulting Co.

TN. No. 92-25  
Supersedes  
TN. No. New

Approval Date AUG 27 1992 Effective Date 4/1/92

Training Provided to Providers, Community Colleges, Public Schools, by  
Consultant, Nurse Aide Certification, Division of Facility Services

Presentations:

**TRAIN THE TRAINER PROGRAM**

1. Sponsored by Division of Facility Services and North Carolina Health Care Facility Administration. . . . . June, 1991
2. Greensboro Area Health Education Center . . . . . October, 1991
3. ProCare Training NAR Program Coordinators, Evergreens, Greensboro Area Health Education Center . . . . . September, 1991
4. Regional Community College, Administrators and Program Coordinators, Gaston Community College. . . . . November, 1991
5. North Carolina Annual Conference of Adult Educators from Community Colleges, Adams Mark, Charlotte, North Carolina. . . . . May, 1992

**SMALL GROUP TRAINING SESSIONS**

1. N.C. Department of Community Colleges meetings with administrators in charge of Nurse Aide Training. . . . . January, 1991  
February, 1991  
May, 1991
2. N.C. Department of Public Instruction meeting with consultants of Health Occupations Education . . . . . May, 1992
3. N.C. Board of Nursing Meeting, Shell Island N.C. . . . . October, 1991
4. N.C. Board of Nursing Headquarters, Raleigh, N.C.. . . . . January, 1992  
February, 1992
5. Task Force for unlicensed Personnel, North Carolina Board of Nursing. . . . . Fall, 1991

**ON-GOING TRAINING THROUGH:**

1. North Carolina Nurse Aide Certification Advisory Committee Day Every . . . . . 1/2 Day Every  
Other Month
2. Hourly/daily communications with health care industry and training programs regarding requirement of nurse aide training and competency and nurse aide registry.
3. Informational documents prepared and mailed to all training programs and competency evaluation programs on a regular basis.

**ACTIVITIES FOR 1992 AND 1993**

1. Participate in Train and Trainer Programs as they are offered through the community colleges and through the Area Health Education Centers.
2. Regional presentations to Community Colleges when requested.
3. Presentation to North Carolina Nurses Association, August 23, 1992.

TN. No. 92-25  
Supersedes  
TN. No. New

Approval Date AUG 27 1992

Effective Date 4/1/92

Revision: HCFA-PM-92-3 (HSQB)  
APRIL 1992

Attachment 4.40-B  
Page 1  
OMB No.:

STATE PLAN UNDER TITLE XIX OF THE SOCIAL SECURITY ACT

State/Territory: North Carolina

ELIGIBILITY CONDITIONS AND REQUIREMENTS

---

Process for the Investigation of Allegations of Resident Neglect  
and Abuse and Misappropriation of Resident Property

---

The State has in effect the following process for the receipt and timely review and investigation of allegation of neglect and abuse and misappropriation of resident property by a nurse aide or a resident in a nursing facility or by another individual used by the facility in providing services to such a resident.

(See attached.)

- \* Abuse, Neglect and Misappropriation of Property: Policy
- \* Abuse, Neglect and Misappropriation of Property: Referrals
- \* Investigation Procedures for Abuse, Neglect and Misappropriation of Property: Investigations
- \* Abuse, Neglect and Misappropriation of Property: Entry of Substantiated Findings into the Nurse Aide Registry

---

TN No. 92-25

Supersedes

Approval Date AUG 27 1992

Effective Date 04-01-92

TN No. NEW

HCFA ID: \_\_\_\_\_

ABUSE, NEGLECT AND MISAPPROPRIATION OF PROPERTY

POLICY: Allegations of resident abuse, neglect and misappropriation of property by a nurse aide or another individual used by a nursing facility or combination facility will be received, reviewed timely and investigated. If an allegation is substantiated, the nurse aide will be notified and an opportunity for a hearing will be provided prior to entering the substantiated finding into the state nurse aide registry. If an allegation is substantiated for another individual, the appropriate licensure authority will be notified.

TN. No. 92-25  
Supersedes  
TN. No. New

Approval Date AUG 27 1992 Effective Date 4/1/92



Procedure: ABUSE, NEGLECT, MISAPPROPRIATION OF PROPERTY; REFERRALS

1. Referrals are received from providers by phone or mail.
  - a. Fill out a referral form upon receipt. Fill out as completely as possible to include names of alleged perpetrator(s), victim(s), witnesses, nature of allegation, date and time of incident, injuries (if any), result of provider's investigation (substantiated/unsubstantiated), and provider's action.
  - b. Determine if allegation has been reported to the county Department of Social Services, local law enforcement agency or other agency. Obtain as much information as possible from the reporter regarding investigations by these agencies.
  - c. Request additional information as needed (i.e. copy of facility investigation, statements of victim, witnesses and alleged perpetrator, incident report, termination notice, orientation and inservice documentation of alleged perpetrator) and indicate items requested on the referral form.
  - d. Make an entry into the referral log.
  - e. When additional information is received from the provider, Department of Social Services, police or other agency, attach information with referral form and update log.
2. Determination of investigation by Abuse, Neglect and Misappropriation of Property Team.
  - a. After review of referral and information received, the Program Manager will determine whether the allegation will be investigated by the Team.
  - b. If an investigation is to be done, the referral is assigned a control number and entered into investigation log.
  - c. If no investigation is to be done, the reason will be noted on the referral form. All related documents will then be attached and filed in the Abuse, Neglect and misappropriation of Property miscellaneous file.
  - d. Mail letters to acknowledge information received and to indicate planned actions to the provider.

TN. No. 92-25  
Supersedes  
TN. No. NEW

Approval Date AUG 27 1992

Effective Date 4/1/92

and other agencies as appropriate.

3. Other reports of abuse, neglect or misappropriation of property when provider has not referred.
  - a. Department of social services:
    - 1) Document on a form substantiated reports of resident abuse, neglect or misappropriation of property by DSS and attach the DSS report.
    2. Indicate on the form that the provider did not report the allegation to DFS
    3. Route form and attachment for assignment of a control number and entry into the abuse, neglect and misappropriation of property log.
    4. Mail a letter to the reporting department of social service acknowledging receipt of the report and the planned action.
  - b. Police:
    - 1) Document on a form, substantiated reports of resident abuse, neglect, and misappropriation of property and attach report from police.
    - 2) Indicate on the form that the provider did not report the allegation to DFS.
    - 3) Route the form and attachments for assignment of a control number and entry into the abuse, neglect and misappropriation of property investigation log.
    - 4) Mail a letter to the reporting police department acknowledging receipt of report and planned action.
  - c. Reports from other sources are to be considered complaints. Please see the procedures for processing and investigating complaints.

TN. No. 92-25  
Supersedes  
TN. No. New

Approval Date AUG 27 1992

Effective Date 4/1/92

INVESTIGATION PROCEDURES FOR ABUSE, NEGLECT and MISAPPROPRIATION OF  
PROPERTY INVESTIGATION

Investigation Tasks:

Task 1 Off Site Preparation

Task 2 Entrance Conference

Task 3 Record Review

Task 4 Interviews

Task 5 Information Analysis and Decisionmaking

Task 6 Exit Conference

Task 7 Off Site Interviews and Follow-up

Task 8 Off Site Information Analysis and Decisionmaking

Task 9 Report Preparation

TN. No. 92-25

Supersedes

TN. No. New

Approval Date AUG 27 1992

Effective Date 4/1/92

Task 1. OFF SITE PREPARATION

Review the facility file for:

correspondence (addressing facility situations that may impact on the investigation)  
recent licensure and/or certification survey-including deficiencies, staffing information, waivers, corrective action status (if appropriate), abuse reports and complaint investigations.

The investigator will review the investigation packet materials prepared by the program manager and determine what specific information will be needed to complete the investigation (ex: specific medical, personnel and inservice records; facility policies, incident reports; police reports etc,.)

The investigator will schedule the visit to the facility. An announced visit may be made when the facility has already provided much of the data needed and the primary purpose of the visit is to conduct interviews.

TN. No. 92-25

Supersedes \_\_\_\_\_

Approval Date Aug 27 1992

Effective Date 4/1/92

TN. No. New

Task 2. ENTRANCE CONFERENCE

The investigator conducts the entrance conference, informs the facility administrator about the investigation. The investigator explains the investigation process and answers questions from facility staff.

Ask the administrator for the specific records needed to conduct the investigation, and the location of the individuals that will need to be interviewed (If staff are not present, the administrator may wish to arrange to have staff come to the facility if possible. The team manager may not require off duty staff to come to the facility to be interviewed.).

Ask the administrator to introduce you to key staff members relevant to the investigation (ex: medical records clerk, bookkeeper, personnel director, director of nursing).

TN. No. 92-25  
Supersedes \_\_\_\_\_  
TN. No New

Approval Date AUG 27 1992 Effective Date 4/1/92

TASK 3. RECORD REVIEW

Review personnel records of the alleged perpetrator and witnesses that are staff members to obtain information needed to complete the investigation report.

Review medical records of residents involved in the alleged incident to obtain information needed to complete the investigation report.

Review facility inservice records, incident reports and facility policies relevant to the investigation.

Request copies of information as needed to supplement the report.

TN. No. 92-25  
Supersedes  
TN. No. New

Approval Date AUG 27 1992 Effective Date 4/1/92

Task 4. INTERVIEWS

Contact interviewees to advise them of the purpose of the interview and to see if they are willing to participate

Interview witnesses individually unless otherwise requested by the interviewee.

Document the conversation and have the interviewee sign the document and have a member of the facility (preferable the DON or the administrator) witness the signature. Signed/witnessed documents will not be necessary for all interviews (ex: interviews with persons who have only general information; persons who have previously signed a prepared statement.).

TN. No. 92-25  
Supersedes  
TN. No. New

Approval Date AUG 27 1992 Effective Date 4/1/92

TASK 5. INFORMATION ANALYSIS AND DECISION MAKING

The investigator reviews and analyzes all data gathered and determines if a decision can be made at this point or what additional information is required. If further information is NOT required and an off site review of the information is NOT required a decision is made based on the data collected. The decision must be made regarding (a) whether a resident's rights violation occurred (b) the acceptability of the facilities actions in hiring, training, evaluation, investigation and follow-up, etc. (c) whether the accused was the perpetrator (d) whether there are licensure or certification deficiencies and how they will be addressed during the exit conference.

If additional information is required from sources outside the facility (interviews with absent staff members, alleged perpetrator, police etc.), the on site visit will conclude with the exit conference.

TN No. 92-25  
Supersedes  
TN. No. New

Approval Date AUG 27 1992 Effective Date 4/1/92



TASK 6. EXIT CONFERENCE

Conduct an exit conference with the administrator. If the investigation has been concluded make known your findings and any deficiencies that will result.

If the investigation will not be completed on site, update the administrator as to what remains to be done. If the probability of a negative action against the facility exists, discuss this with the administrator.

TN. No 92-25  
Supersedes  
TN. No. New

Approval Date AUG 27 1992 Effective Date 4/1/92

TASK 7. OFF SITE INTERVIEWS AND FOLLOW UP

There will usually be one person conducting a specific investigation; that person would be responsible for completing the off site investigation interviews and following up any additional information. When a second person has assisted with the investigation, the chief investigator may designate off site tasks to that individual.

Document all attempts to contact witnesses and alleged perpetrator. When telephone contact has not been successful or is inconvenient, a certified letter may be sent to the individual. When it is practical, contacts should be made in person.

TN. No. 92-25  
Supersedes  
TN. No. New

Approval Date AUG 27 1992 Effective Date 4/1/92

TASK 8. OFF SITE INFORMATION ANALYSIS AND DECISIONMAKING

Review all data relating to the incident and make a decision based on facts and witness credibility.

TN. No 92-25  
Supersedes  
TN. No. New

Approval Date AUG 27 1992 Effective Date 4/1/92

TASK 9. REPORT PREPARATION

Compile the information into report form using the appropriate DFS and HCFA forms.

If a deficiency is cited it should be written in terms specific enough to allow a reasonably knowledgeable person to understand the aspect(s) of the requirements(s) that is (are) not met. The format should follow the current HCFA or DFS Licensure guidelines as applicable.

The facility administrator will be notified in writing of the outcome of the investigation upon completion and of any negative action taken or proposed against the facility.

The alleged perpetrator will be notified in writing by the program manager of the outcome of the investigation and any action to be taken against same in addition to what rights the perpetrator has to challenge the conclusion.

The facility has the right to appeal any negative action in accordance with the law and established DFS policies and procedures.

TN. No 92-25  
Supersedes  
TN. No. New

Approval Date AUG 27 1992 Effective Date 4/1/92

Procedure: ABUSE, NEGLECT AND MISAPPROPRIATION OF PROPERTY: ENTRY  
OF SUBSTANTIATED FINDINGS INTO THE NURSE AIDE REGISTRY

1. Notice to nurse aide by mail.
  - a. A letter notifying the nurse aide with a substantiated finding of abuse, neglect or misappropriation of property is to be filled out by the staff member investigating the allegation. The letter includes the notice of a substantiated finding, the intent to enter the finding into the nurse aide registry, the opportunity to appeal the finding through informal procedures and formal contested case hearing through the Office of Administrative Hearings, and the opportunity to submit a rebuttal to be entered into the nurse aide registry along with the finding.
  - b. The completed letter and the documentation of the investigation is reviewed and approved by the Program Manager.
  - c. The letter and documentation is then forwarded to the Chief of the Licensure Section for approval and signature.
  - d. The letter is sent to the nurse aide by certified mail.
  
2. Notice to nurse aide by publication.
  - a. If the registered letter returns nondeliverable, a notice of service of process by publication is filled out.
  - b. The notice by publication is sent to a newspaper circulated in the county where the nurse aid is believed to be located, or if there is no reliable information concerning the location of the nurse aide, then in a newspaper circulated in the county where the action is pending.
  - c. An affidavit is to accompany the notice of service of process by publication to the publishing newspaper.
  - d. A letter advising the newspaper to publish the notice once a week for three consecutive weeks and to sign and notarize the affidavit, filling in the three dates the notice ran in their paper is also to accompany the notice.

3. Substantiated finding not contested by a nurse aide.
  - a. An entry of a substantiated finding is entered into the nurse aide registry by the tenth working day following the opportunity for appeal.
  - b. The nature of the allegation, the evidence that led to the conclusion the allegation was valid and, if submitted, a rebuttal statement by the nurse aide is entered with the nurse aide's listing on the registry.
  - c. The nurse aide is notified of the content of the entry by mail once the entry is made.
4. Substantiated finding appealed through informal procedures.
  - a. Upon receipt of a request for appeal through informal procedures, a meeting is scheduled for the nurse aide with the Section Chief.
  - b. The Section Chief determines the outcome of the substantiated finding.
  - c. The nurse aide is notified of the decision of the Section Chief by mail.
  - d. If the substantiated finding is upheld, an entry is made with the nurse aide's listing on the registry as in 3. b. above.
  - e. The nurse aide is notified of the content of the entry by mail once the entry is made.
5. Substantiated finding contested.
  - a. A petition for a contested case hearing is filed by the nurse aide with the Office of Administrative Hearings within the appeal time frame specified by G.S.131E-111 and in accordance with G.S. 150B.
  - b. If the substantiated finding is upheld by the Office of Administrative Hearing Judge and the Division Director, an entry is made of the finding with the nurse aide's listing on the registry as in 3. b. above including the date of the hearing and the outcome.
  - c. The nurse aide is notified of the content of the entry

by mail once the entry is made.

- a. Submission of a rebuttal statement.
  - a. If a rebuttal statement disputing the allegation is submitted by the named nurse aide, the rebuttal statement is entered into the nurse aide registry with the substantiated finding.
  - b. The rebuttal statement may be edited to ensure the statement is brief enough to fit into the space provided by the registry.
  - c. The nurse aide is notified of the content of the entry by mail once the rebuttal statement is entered.

TN. No 92-25  
Supersedes  
TN. No. New

Approval Date AUG 27 1992 Effective Date 4/1/92

ABUSE, NEGLECT AND MISSAPPROPRIATION OF PROPERTY:  
POLICY AND PROCEDURES

Approved by:

Jaime C.M. Bunn, Program Manager,  
Abuse, Neglect and Misappropriation of Property Team

Dorinda B. Fisher, Assistant Branch Head,  
Complaints Investigation Branch

Jan Stul, Section Chief,  
Licensure Section

TN. No. 92-25  
Supersedes  
TN. No. New

AUG 27 1992  
Approval Date \_\_\_\_\_ Effective Date 4/1/92



Revision: HCF-pm-92-3 (HSQB)  
APRIL 1992

Attachment 4.40-C  
Page 1  
OMB No.:

STATE PLAN UNDER TITLE XIX OF THE SOCIAL SECURITY ACT

State/Territory: North Carolina

ELIGIBILITY CONDITIONS AND REQUIREMENTS

---

Procedures for Scheduling and Conduct of Standard Surveys

---

The State has in effect the following procedures for the scheduling and conduct of standard surveys to assure that it has taken all reasonable steps to avoid giving notice.

All Survey Agency staff are trained in accordance with, and individually issued, Appendix P, Survey Procedures for Long Term Care Facilities, which states "Do not announce SNF/NF survey. The Life Safety Code survey must not precede the survey of resident care requirements."

Survey schedules are developed, documented and distributed within the agency as "confidential" and "nondisclosable." All surveyor agency staff are informed in their orientation that any form of disclosure of survey schedules will subject the employee to monetary fine and termination of employment. Staff is furthermore instructed to report immediately to the Section Chief any suspected discrepancies. The policy for "unannounced" surveys is reviewed periodically in staff meetings. Life Safety Code surveys are conducted after the standard survey has been completed. Surveyors do not divulge the nature of their business when making logging/travel arrangements nor are families of surveyors allowed to contact surveyors on-site. All calls are routed through the State Agency.

---

TN No. 92-25

Supersedes

Approval Date AUG 27 1992

Effective Date 04-01-92

TN No. New

STATE PLAN UNDER TITLE XIX OF THE SOCIAL SECURITY ACT

State/Territory: North Carolina

ELIGIBILITY CONDITIONS AND REQUIREMENTS

---

Programs to Measure and Reduce Inconsistency

---

The State has in effect the following programs to measure and reduce inconsistency in the application of survey results among surveyors.

The Certification Section of Division of Facility Services is in the process of:

- a. Developing and implementing a Q.A. program targeting LTC that is managed by the Q.A. Officer  
  
is based on the HCFA On-Site Performance and Training Survey (OSPATS) module to include on-site process and end line review  
  
receives input from QLI - QIT 4; members of the team and/or designees in Q.A. surveillance  
  
provides Q.A. findings and consultation to Section Management  
  
incorporates Q.A. findings into Training needs assessment  
  
provides Technical Assistance to managers and surveyors as on request or as directed by Section Chief
- b. Developing retrieval system from existing Quality Control units to collecting and utilize Q.C. data in the Q.A. program.

---

TN No. 92-25

Supersedes

Approval Date AUG 27 1992

Effective Date 04-01-92

TN No. New

Revision: HCF-pm-92-3  
APRIL 1992

(HSQB)

Attachment 4.40-E  
Page 1  
OMB No.:

STATE PLAN UNDER TITLE XIX OF THE SOCIAL SECURITY ACT

State/Territory: North Carolina

ELIGIBILITY CONDITIONS AND REQUIREMENTS

---

Process for Investigations of Complaints and Monitoring

---

The State has in effect the following process for investigating complaints of violations of requirements by nursing facilities and monitors onsite on a regular, as needed basis, a nursing facility's compliance with the requirements of subsection (b), (c), and (d) for the following reasons:

- (i) the facility has been found not to be in compliance with such requirements and is in the process of correcting deficiencies to achieve such compliance;
- (ii) the facility was previously found not to be in compliance with such requirements and has corrected deficiencies to achieve such compliance, and verification of continued compliance is indicated; or
- (iii) the State has reason to question the compliance of the facility with such requirements.

(See attached.)

---

TN No. 92-25  
Supersedes  
TN No. New

Approval Date AUG 27 1992 Effective Date 04-01-92

OPERATIONAL POLICIES AND PROCEDURES  
FOR PROCESSING AND INVESTIGATING COMPLAINTS

PURPOSE:

To establish a quality control policy to assure that all complaints are appropriately investigated and reported in accordance with approved procedures; thus assuring uniform handling of complaints regarding licensed and certified facilities.

Policy:

The Branch Head or her designee is responsible for assuring that all complaints are properly recorded and investigated, within forty-five (45) days and a response sent to the complainant and all involved parties within sixty (60) days from the receipt of the complaint.

Complaints concerning care, treatment, or services at licensed health care facilities and which are within the jurisdiction of the Division of Facility Services (DFS) Licensure Section will be accepted for investigation. Each complaint will be assessed to determine the type investigation required. Allegations which are not within the jurisdiction of the Licensure Section will be referred to the proper agency/office.

When complainants indicate that they have not attempted to resolve concerns with facility management, they will be encouraged

TN No. 92-25  
Supersedes  
TN No. New

Approval Date AUG 27 1992

Effective Date 04-01-92

do so. If complaints are unable to achieve a satisfactory resolution with facility management, a complaint will be accepted for investigation by the Complaints Investigation Branch (CIB).

Anonymous complaints will be accepted.

Confidentiality will be maintained of all known complainants and all medical records inspected. When complaint files are reviewed by the public, all confidential information will be removed from the file prior to the review in accordance with G.S. 131E-105 and G.S. 131E-124(C).

PROCEDURE:

Complaints will be accepted by telephone, mail, or office visits by the complainant or by referral from other agencies.

- A. Telephone complaint will be taken by CIB Staff.

Complaints will be entered on a complaint information form (attached).

- B. Appointments will be scheduled for complainants who wish to lodge their complaint in person. These complaints will be entered on a complaint information form.

- C. When complainants have not attempted to resolve their concerns with facility management but indicate willingness to do so, a report for record will be completed following the initial contact; and arrangements made for recontact with the complainant within one week to determine the facility's response to concerns. When facility's

response has been unsatisfactory to the complainant, a complaint will be recorded for investigation by the CIB during the second contact. If complainants have any hesitancy in talking with facility management, a complaint will always be taken during the initial contact.

II. Upon receipt, complaints are directed to the Branch Head or her designee who will:

- A. Review the complaint.
- B. Label the complaint with the complaint category (ies).
- C. Write a letter to the complainant acknowledging receipt of the complaint.
- D. Decide whether all or portions of the complaint should be referred to other agencies/groups, etc.
  1. Complaints alleging abuse, neglect, or exploitation of a specifically named patient are immediately referred to the County Department of Social Services, Adult Protective Services, in accordance with the agreement between Division of Facility Services and Division of Social Services. In accordance with G.S. 108A-103 the Division of Social Services (DSS) will make "a prompt and thorough evaluation to determine whether the individual is in need of protective services." When in the course of the DSS investigation it becomes apparent that the abuse, neglect, or exploitation will be substantiated, the county DSS director will be immediately notify DFS by phone. The CIB will assess data from the DSS to determine

whether there is an on-going and current threat to the patient's health and safety, and if so, the CIB will investigate the situation within two working days.

2. Assistance may be requested from Nursing Home Community Advisory Committees (NHCAC) when allegations are of a general nature and do not require special, professional expertise for investigation. The Branch Head will contact the Division of Aging Regional Ombudsman to determine if the NHCAC is capable of investigating the specific complaint and able to provide the requested assistance.
3. If referrals are made, a note to this effect is made on the complaint form indicating the date of referral and to whom it was referred.

III. Following initial review, the Branch Head will send complaints to the branch Administrative Assistant who will:

- A. Assign a complaint number.
- B. Enter the complaint on the complaint log.
- C. Prepare a folder and large envelope labeled with the facility name and location and the complaint number, and the date of 45<sup>th</sup> day following receipt.
- D. Type and mail the acknowledgement letter to the complainant.
- E. Make a copy of the complaint and place it in the large envelope for the investigator to use as a working copy.
- F. Place the original complaint and a copy of the letter to

TN No. 92-25  
Supersedes  
TN No. New

Approval Date AUG 27 1992

Effective Date 04-01-92

the complainant in the file folder for filing in the complaint file, which is to maintained separately form the licensure files and certification files.

- IV. the Branch Head or her designee will assign complaints to staff for investigation. During periods of heavy work load, the Branch Head may request assistance from Health Care Facilities Branch (HCFB) staff to assure the 45 day deadline is met.
- A. Routinely, complaints will be scheduled for investigation in the order received.
  - B. Complaints requiring prompt attention, as noted above, will be investigated within two working days. These would include allegations which imply that there is an imminent threat to a patient's health, safety, or welfare.
  - C. Complaints will be investigated either by unannounced visits to the facility or through phone contact with the facility administrator. The Branch Head or her designee will decide whether a complaint will be investigated by phone or an onsite visit, based upon the type of investigation method required. An onsite visit will always be made when allegations require monitoring of employee performance or observation of identified conditions.
  - D. When a survey or onsite complaint investigation has been held at a facility within thirty days prior to the receipt of a complaint about that facility, another onsite visit will not be scheduled if allegations can be answered based on findings during the recent survey or investigation.

TN No. 92-25  
Supersedes  
TN No. New

Approval Date AUG 27 1992

Effective Date 04-01-92



- E. Each investigation will be individually planned to assure that complete information is available for determining the validity of the complaint.
1. Information will be obtained from a variety of sources to determine consistency and accuracy.
  2. Methods will include such things as patient assessments, Record reviews, monitoring of staff performance and interviews with patients, visitors and staff.
  3. Persons and agencies will be contacted as necessary to obtain needed information.
  4. All certification related complaints against skilled nursing facilities and/or intermediate care facilities will be investigated using the Long Term Care (LTC) Process as mandated by Federal Regulation 42 CFR 488.1100 (8) (2)

V. Onsite Investigations

- A. Onsite visits to nursing homes will be unannounced. Announced visits may be made to hospitals and other programs and agencies if this would not compromise the value or collection of relevant data.
- B. Staff assigned to do onsite investigations are responsible for planning strategies for conducting the investigation prior to the onsite visit.
- C. When two or more staff are assigned to an investigation, one person will be identified to serve as team leader. The team leader is responsible for the following:

1. Developing the investigation plan, using input from team members.
  2. Meeting with team members prior to entering the facility to review the investigation plan and make assignments.
  3. Conducting an entrance conference with the facility administrator (or person in charge in his absence) to explain the general nature of the allegations and to review the general plan for the investigation.
  4. Holding a pre-exit conference with team members to share findings and make decisions about any actions to be taken.
  5. Conducting an exit conference with the administrator at the conclusion of the investigation to review the specific allegation(s) and findings of the investigation. If additional data is needed and a final decision cannot be made prior to leaving the facility, the team leader will explain this to the administrator and that he will be notified of final decisions by phone.
  6. Completing the complaint report, required letters, and associated paperwork.
- VI. If state licensure violations are identified as a result of a complaint investigation, these are to be handled according to DFS licensure section policy. If federal deficiencies are identified, certification actions are to be initiated in accordance with the State Operations Manual.

TN No. 92-25  
Supersedes  
TN No. New

Approval Date AUG 27 1992

Effective Date 04-01-92

- VII. Reports from referred complaints are reviewed by the Branch Head or her designee. If a report identifies possible violations of State or Federal requirements, or otherwise suggests a need for further investigations by the CIB, this will be scheduled.
- VIII. From time to time, certain complaints may be referred for investigation by the office of the Governor, the Secretary, a legislator or from some other source that make it necessary to give the complaint special handling. For such complaints, beside the usual processing procedures, the following additional guidelines shall be followed:
- A. The Branch Head shall insure that the Licensure Section Chief is aware of all complaints received through the offices of the Governor, the Secretary or a legislator.
  - B. When investigations are complete, a report shall be made to the referring office advising of the findings and any actions that may be anticipated in the future. These reports shall be routed through the Section Office.
  - C. In cases where the Governor or Secretary needs to respond directly to a complaint or referring legislator, a draft response shall be prepared and forwarded to the Section Office for review and final processing. Care shall be taken to insure that responses are timely and meet established deadlines.
  - D. Any complaint received that appears to have the potential for becoming a sensitive issue shall be brought to the attention of the Section Chief and he shall be kept

VII. Following an investigation, the team leader or investigator will:

- A. Prepare a report which will include the allegation(s), summary of the investigation, conclusion(s), and action taken using the complaint investigation report form (attached. Following completion reports will be given to the Branch Head or her designee for review and routing to the Licensure Section Chief prior to its being filed.
- B. Send a letter to the administrator within ten day of the investigation stating whether or not the complaint was substantiated.
  1. If recommendations were made, these are to be included in the letter.
  2. If deficiencies were cited, the DFS-4093 and instructions sheets and the HCFA 2567 are to accompany the letter.
  3. If administrative action is recommend, this is to be stated in the letter and that management action, is taken, will be sent in a separate mailing.
- C. Write a letter to the complainant to be sent within sixty days from the receipt of the complaint. This letter should include at a minimum:
  1. The date of the investigation.
  2. A summary of the investigation methods used.
  3. Whether the allegations were substantiated, not substantiated, or partially substantiated.

TN No. 92-25  
Supersedes  
TN No. New

Approval Date AUG 27 1992

Effective Date 04-01-92

informed of any unusual developments as the investigation proceeds.

Signature: Jean W. Smith  
Title: Branch Head  
Date: 2/13/90

TN. No. 92-25  
Supersedes  
TN. No. New

AUG 27 1992  
Approval Date \_\_\_\_\_ Effective Date 4/1/92

STATE PLAN UNDER TITLE XIX OF THE SOCIAL SECURITY ACT  
State/Territory: North Carolina

False Claims Act Compliance Plan

This document outlines how the Medicaid agency identifies, notifies and reviews providers that meet the definition of “entity” each year and thus fall under the requirements for employee education about false claims recovery outlined in Section 1902(a)(68) of the Social Security Act. This document also describes how the agency will review providers on an ongoing basis for compliance and the frequency of review.

Annually, beginning with 2007, the Medicaid agency will identify providers and contractors that provide Medicaid health care items or services that were paid \$5 million dollars or more. The identified providers and contractors will be notified by letter that they were paid a minimum of \$5 million dollars last calendar year and, as such, are subject to the requirements for employee education about false claims recovery as cited in 1902(a)(68) of the Social Security Act. The providers and contractors will also be required to sign a letter of attestation that they have complied with the requirements of 1902(a)(68) of the Social Security Act. Providers will be notified by September 30<sup>th</sup> of each year if they were paid \$5 million or more and will have 30 days to submit signed letters of attestation. These signed letters of attestation will be stored by the agency as either a hard copy or as an electronically signed document.

The Medicaid agency will collect signed letters of attestation for all providers at initial enrollment and re-enrollment in the Medicaid Program. Providers and contractors whose Medicaid payments meet or exceed \$5 million annually, that fail to attest that they have complied with the requirement of employee education about false claims recovery as cited in 1902(a)(68) of the Social Security Act (to the agency), will have all future Medicaid payments suspended. The Medicaid agency will review the policies and procedures of the identified providers through routine and random audits on an ongoing basis to assure compliance with 1902(a)(68) of the Social Security Act.

---

TN. No.: 07-005  
Supersedes  
TN No.: New

Approval Date: 06/27/07

Effective Date: 01/01/07

STATE PLAN UNDER TITLE XIX OF THE SOCIAL SECURITY ACT  
Attachment 7.2-A

MEDICAL ASSISTANCE PROGRAM

State: North Carolina

NONDISCRIMINATION

---

---

The State plan assuring compliance with Title VI of the Civil Rights Act of 1964 is on file in the Regional Office of the Department of Health, Education, and Welfare.

Rec'd 12-26-73

R.O. Action 7-19-74

Eff. Date 10-1-73

Obsoleted by \_\_\_\_\_

Dated \_\_\_\_\_

North Carolina Department of Health and Human Services  
Division of Social Services

Methods of Administration  
For  
Title VI Compliance  
Of the  
Civil Rights Act of 1964

Name of Program: MEDICAL ASSISTANCE (TITLE XIX MEDICAID)

I. Assignment of Responsibility

- A. Over all coordinating responsibility for the Department of Health and Human Services Mr. Harold Maness, Director of Plans and Programs
- B. Title VI Compliance in nursing homes and hospitals  
Mr. John A. McCann, Civil Rights Coordinator, Division of Facility Services
- C. Title VI reviews of physicians, drug stores, and other vendors  
Assistant Chief of Practitioner Services, Medical Services  
Section of the Division of Social Services. The Assistant Chief of Practitioner Services consults with Mr. James E. Coats, Civil Rights Coordinator for the Division of Social Services

II. Dissemination of Information

- A. Staff  
All staff are provided copies of the North Carolina Department of Health and Human Services Title VI policy statement. In addition, staff is briefed on the Division of Social Services plan and the Title XIX Methods of Administration. This information includes departmental and division responsibilities, vendor responsibilities, staff responsibilities, the dissemination of information procedures, clients rights to services, procedure for clients filing of complaints, methods of handling of complaints, and procedures for handling instances of non-compliance. This information is provided at the first in-service orientation for staff. Thereafter, it is discussed infrequently at staff meetings and supervisory conferences.

The information provided to staff is being developed and copies will be forwarded the Region IV Office for Civil Rights. The information will contain the meaning of Title VI with examples of what to look for in observing compliance or non-compliance.

Rec'd 12-26-73

73-45

Dated 12/21/73

R.O. Action 7-19-74

Eff. Date 10-1-73

Obsoleted by \_\_\_\_\_

Dated \_\_\_\_\_



B. Vendors

All vendors are advised of Title VI requirements at the time of admission to the program. Each vendor receives semi-annual visits from Medical Services staff at which time they are reminded of Title VI requirements. Vouchers contain a compliance agreement.

Copies of Title VI information sent to vendors is being drafted and will be forwarded to the Region IV Office for Civil Rights. This information is mailed to all vendors and is reviewed by the Provider Representative upon an on-site visit.

C. Clients and Applicants

The responsibility for giving Title VI information to clients and applicants is delegated to county department of social services intake workers, eligibility specialists, and social workers. Clients and applicants are advised that if they feel they are the subject of discrimination, they may receive an administrative hearing at the county level, or they may request a formal hearing from a state staff appeals and hearings officer. If they wish to file a written complaint of discrimination, forms are provided at the county level. They may call the complaint in on the Department of Health and Human Services "Hotline" or they may write to the state office or to the Regional or National Department of Health, Education, and Welfare. When this information has been provided, a notation to that effect is entered in the client's record. The client and/or applicant is given a booklet of program information which includes Title VI information. There is no scheduled periodic reissuance of this in-client is reminded of rights under Title VI.

D. Public

Booklets which contain information in reference to services available to clients and applicants are available in lobbies and waiting rooms of county departments of social services. These booklets contain a Title VI statement. The Division of Social Services issues a statement of non-discrimination news release to all news media. Social Services staff are advised to mention Title VI policy when meeting with community groups and making presentations.

III. Maintaining and Assuring Compliance

A. Reviews of Hospitals and Nursing Homes

The Division of Facility Services has six staff persons to review these facilities via annual on-site visits. These reviews include information as to the following:

The service area and population by race  
Principal administrator  
Licensed bed capacity  
Number of rooms: private, semi-private and wards  
Room occupancy inspection (patient count)  
Physicians and dentists in the service area with racial breakdown  
Staff privileges by race  
Courtesy titles  
Training programs with minority participation  
Title VI and open admissions information  
Patient(room transfers)  
Board chairman and racial makeup of boards

Title VI Compliance clearance is required prior to issuance or re-issuance of a provider number. Since this is a vital area, Mr. John A. McCann, Civil Rights Coordinator, is required to review the annual on-site reports and sign off regarding Title VI

1) Exchange of Compliance Information

The Division of Facility Services provides a listing of facilities certified for Title VI clearance. This listing is providing to Social Services at the county and state level and is updated with supplemental as facilities are added or deleted. The complete list is published annually. When a facility applies for admission to the program, Mr. John A. McCann, Civil Rights Coordinator for the Division of Facility Services, is immediately notified. While licensing requirements are being inspected, Mr. McCann consults on Title VI requirements.

2) Files regarding these facilities are maintained in the Division of Facility Services. These files are available for review by Division of Social Services staff and the Office for Civil Rights.

3) Resolving areas of non-compliance

When non-compliance has been determined, the Director of the Division of Facility Services will send a certified letter to the Administrator of the facility noting the areas of non-compliance. The letter gives the facility a stated period of time in which to correct its discrepancy or face suspension from the program. The notification includes the right of appeal and a hearing before the Director of the Division of Facility Services, or an appointed hearing officer. The Secretary of the Department of Health and Human Services will review the findings of the hearing and will render a decision in the matter of non-compliance.

B. Other Vendors

1) Responsibility

The Division of Social Services has compliance responsibility for all vendors having "provider numbers". Mr. Emmett Sellers, Chief of the Medical Services Section has responsibility for determining that payments are not made to individual vendors in violation of Title VI.

2) On-Site Inspections

All individual vendors receive semi-annual on-site program maintenance visits. These are not called civil rights inspections. Areas of compliance are noted but unless there is an evidence of non-compliance there is no report filed. Medical Services staff observe waiting rooms, courtesy titles, appointment patterns, and the seeing of patients in the order of their arrival. One person, a Provider Representative makes the on-site inspection. The attached form, Title VI Monitoring Report is completed annually and is maintained in the Medical Services Section for review by Medical Services staff and the Office for Civil Rights.

IV Handling Complaints

All complaints are filed through the Office of the Director of Plans and Programs of the Department of Health and Human Services who assigns them to the appropriate division. The complainant is immediately notified of the receipt of his complaint. The complainant receives a personal visit in which he is helped to amplify his complaint and present any evidence he may have. The facility or vendor is contacted in reference to the complaint. A report is

written which includes all aspects of the information obtained. Wherein necessity dictates, community residents and/or others may be contacted in order to ascertain the extent of the problem. The complainant as well as the accused is notified of the results of the investigation. The complainant is informed of his rights and options for pursuing the matter further if he desires.

When a complaint is filed against an individual provider, Mr. James E. Coats, Civil Rights Coordinator for the Division of Social Services, coordinates and participates in all investigations jointly with Medical Services personnel. When a violation is determined to exist, the Director of the Division of Social Services will, by certified mail, notify the offender of the areas of non-compliance. A stated period of time is allowed to correct deficiencies or face suspension from the program. The offender is also informed of his right to a hearing with the Director or an appointed hearings officer.

When a complaint is filed against a facility, Mr. John A. McCann, Civil Rights Coordinator for the Division of Facility Services, will coordinate and participate in all investigations. When a violation is determined to exist, the Director of the Division of Facility Services will notify the offender within the same conditions as described above.

The Secretary of the Department of Human Resources will review the findings of the hearing and will render a final decision in the matter of non-compliance.

V. RECRUITMENT AND TRAINING

- A. All persons are employed from a State Merit System Register. Placements on the register are in accordance with test grades.
- B. Training for the specific job is a requirement for all employees, and is so stated at the time of employment. All employees receive the same training through orientation and supervision regardless of race, color, or national origin. "All applicants and all staff are advised of the availability of training."

  
\_\_\_\_\_  
Signature of Responsible  
Departmental Official  
Director, Division of Social Services

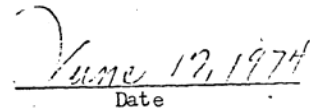
  
\_\_\_\_\_  
Date

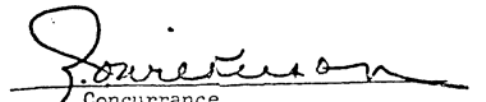
  
\_\_\_\_\_  
Concurrence  
Director, Division of Facility Services

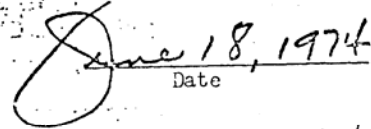
  
\_\_\_\_\_  
Date

Rec'd 12/26/73 11 # B3-45 Date 12/21/73

R.O. 7/19/74 11/10/73

Obsolated by \_\_\_\_\_ Dated \_\_\_\_\_